

Conference Report

The 3rd International Conference on
Energy Efficiency in Historic Buildings

Edited by

Tor Broström, Lisa Nilsen and Susanna Carlsten



Conference Report

Energy Efficiency in
Historic Buildings

Visby Sweden

September 26–27, 2018

Editors: Tor Broström, Lisa Nilsen and Susanna Carlsten

Publisher: Uppsala University, Department of Art History

Address: Uppsala University Campus Gotland, 621 67 Visby

Web: <http://www.konstvet.uu.se/kulturvard/>

ISBN: 978-91-519-0838-0

Layout: Alice Sunneback/JASun KB.

Contents

Preface 9

Day 1 – Joint session

Understanding the change of heritage values over time and its impact on energy efficiency..... 11

K. Fouseki and Y. Bobrova

Energy savings due to internal façade insulation in historic buildings.....22

E.J. de Place Hansen and K.B. Wittchen

Day 1 – Session 1

Outlining a methodology for assessing deterioration threshold criteria32

L. Lång, P. Johansson, C-M. Capener, H. Janssen, J. Langmans, E. Møller, M. D’Orazio and E. Quagliarini

How to estimate material properties for external walls in historic buildings before applying internal insulation..... 41

E.J. de Place Hansen and E.B. Møller

Can probabilistic risk assessment support decision-making for the internal insulation of traditional solid brick walls?.....50

V. Marincioni and H. Altamirano-Medina

The effect of climate change on the future performance of retrofitted historic buildings..... 60

L. Hao, D. Herrera and A. Troi

Hygrothermal properties of NHL mortars 71

P.F.G. Banfill

Performance of insulation materials for historic buildings 80

P. Johansson, A. Donarelli and P. Strandberg

Cultural heritage compatible insulation plaster..... 89

N.R.M. Sakiyama, J. Frick and H. Garrecht

Performance of interiorly insulated log wall99

T. Kalamees, E. Arumägi and Ü. Alev

Investigations on the influence of different types of restoration of beam ends of the floor in the Alte Schäfflerei Benediktbeuern..... 108

M. Krus, A. Thiel and R. Kilian

<i>Investigation of post-insulated walls with wooden beam ends.....</i>	118
J. Borderon, E. Héberlé, A. Cuny and J. Burgholzer	
<i>Removable textile devices to improve the energy efficiency of historic buildings.....</i>	127
V. Pracchi, E. Rosina, A. Zanelli and C. Monticelli	
<i>The “Waaghaus” of Bolzano.....</i>	135
D. Exner, M. Larcher, A. Belleri, A. Troi and F. Haas	
<i>3D spatial reconstruction and non-destructive energy diagnostics of building interiors with smart devices.....</i>	145
C.D. Şahin and M.P. Mengüç	
<i>Combining multi-view photogrammetry and wireless sensor networks when modelling the hygrothermal behaviour of heritage buildings.....</i>	154
S. Dubois, M. de Bouw, Y. Vanhellemont, D. Stiernon and S. Trachte	
<i>Data fusion to synthesise quantitative evidence, value and socio-economic factors</i>	163
S.A. Orr	

Day 1 – Session 2

<i>Value creation by re-renovation</i>	172
P. Femenías, P. Eriksson, L. Thuvander, K. Mörk, P. Wahlgren and P. Johansson	
<i>Benign changes and building maintenance as a sustainable strategy for refurbishment of historic (Pre-1919) English dwellings</i>	182
J. Ritson	
<i>What’s behind the façade?</i>	191
G. Leijonhufvud, M. Tunefalk and M. Legné	
<i>Energy efficiency assessment of Indo-Saracenic buildings in India</i>	199
Ar. S. Choudhary, Dr. S. Pipralia and Dr. N. Kumar	
<i>The approach of the Walloon Heritage Agency on the energy upgrade of listed buildings</i>	207
P. Delhaye	
<i>Analytic hierarchy process</i>	216
E. Gigliarelli, F. Calcerano and L. Cessari	
<i>Decision support tool for the innovative and sustainable renovation of historic buildings (HISTool).....</i>	226
W. Hüttler, D. Bachner, G. Hofer, M. Krempl, G. Trimmel and I. Wall	
<i>Historic Building Atlas</i>	236
F. Haas, D. Herrera, W. Hüttler, D. Exner and A. Troi	

<i>Life cycle assessment of Villa Dammen</i>	246
M. Fuglseth, F. Berg, B. Sandberg-Kristoffersen and M. Boro	
<i>The ROT programme, energy efficiency, and historical values in buildings in Sweden</i>	255
M. Tunefalk and M. Legnér	
<i>Energy Performance Certification</i>	264
M.R. Mallia and O. Prizeman	
<i>Development of a knowledge centre for responsible retrofit of traditional buildings in France</i>	274
J. Burgholzer, E. Héberlé, H. Valkhoff, J.P. Costes and J. Borderon	
<i>Potentialities and criticalities of different retrofit guidelines in their application on different case studies</i>	283
V. Pracchi and A. Buda	
<i>Technical guidelines for energy efficiency interventions in buildings constructed before 1955 in Greece</i>	294
E. Alexandrou, M. Katsaros, D. Aravantinos, K. Axarli, A. Chatzidimitriou, A. Gotoudis, Th. Theodosiou and K. Tsikaloudaki	
<i>A method to assess the potential for and consequences of energy retrofits in Swedish historic districts</i>	302
B. Moshfegh, P. Rohdin, V. Milic, A. Donarelli, P. Eriksson and T. Broström	

Day 2 – Session 1

<i>Heat pumps for conservation heating in churches</i>	311
P. Klenz Larsen	
<i>Design of indoor climate and energy efficiency of the medieval Episcopal Castle of Haapsalu museum</i>	318
T. Tark, T. Kalamees, A. Rodin, E. Arumägi and M. Napp	
<i>Adaptive ventilation to improve IEQ</i>	327
M. Lyszczas and K. Kabele	
<i>Different HVAC systems in historical buildings to meet collection demands</i>	337
L. Krzemień, A. Kupczak, B. Pretzel, M. Strojcki, J. Radoń and E. Bogaczewicz-Biernacka	
<i>Status determination and risk assessment of measures in historic buildings</i>	345
J. Arfvidsson, B. Bjelke-Holtermann and J. Mattsson	
<i>Preservation strategy and optimization of the microclimate management system for the Chapel of the Holy Trinity in Lublin</i>	354
A. Sadłowska-Sałęga, J. Sobczyk, J.M. del Hoyo-Meléndez, K. Wąs and J. Radoń	

<i>Effect of intervention strategies on seasonal thermal comfort conditions in a historic mosque in the Mediterranean climate</i>	363
K.S.M. Bughrara, Z. Durmuş Arsan and G. Gökçen Akkurt	
<i>A baroque hayrick as storage centre for pipe organs</i>	372
S. Bichlmair, M. Krus and R. Kilian	
<i>Study of the indoor microclimate for preventive conservation and sustainable management of historic buildings</i>	381
A. Bonora, K. Fabbri and M. Pretelli	
<i>An unfair reputation: The energy performance of mid-century metal-and-glass curtain walls</i>	391
D. Artigas, S. O'Brien and A. Aijazi	
<i>Energy efficiency and preservation of 20th century architecture</i>	401
D. Del Curto, C.M. Joppolo, A. Luciani and L.P. Valisi	
<i>The impact of modernization of a 16th century timber-framed farmhouse, Suffolk, UK</i>	413
C.J. Whitman, O. Prizeman, J. Gwilliam and P. Walker	
<i>Integrated energy and hygrothermal analyses of heritage masonry structures in cold climates</i>	423
M. Gutland, S. Bucking and M. Santana	
<i>How sustainable was Connecticut's historic Saltbox house?</i>	433
T. Sawruk, T. Adekunle and J. Hegenauer	

Day 2 – Session 2

<i>It's not the end of the World (Heritage Site)</i>	444
M. Legnér and M. Tunefalk	
<i>Examining the energy performance of older and historic buildings using municipal benchmarking data</i>	453
A.L. Webb, L. Beckett and M.D. Burton	
<i>Heritage values and thermal comfort in Neoclassical residential buildings of Athens, Greece</i>	463
T. Koukou and K. Fouseki	
<i>Energy efficiency intervention and preservation in residential built heritage</i>	472
E. J. Uranga, L. Etxepare, I. Lizundia and M. Sagarna	
<i>Building stock analysis as a method to assess the heritage value and the energy performance of an Alpine historical urban settlement</i>	482
E. Lucchi, D. Exner and V. D'Alonzo	
<i>Improving the energy efficiency of built heritage in cold regions</i>	493
A. Luciani, K.L. Nilsson, S. Lidelöw, S. Bhattacharjee and T. Örn	

Categorization of the heritage building stock in Cairo for the energy planning purposes503

E. Raslan, A. Donarelli and E. De Angelis

On the use of change-point models to describe the energy performance of historic buildings 512

P. Rohdin, V. Milic, M. Wahlqvist and B. Moshfegh

Theory and practice, a longitudinal study on developing an energy solution for the Der Aa-church521

M. Vieveen

Heritage values as a driver or obstacle for energy efficiency in Victorian and Edwardian buildings.....530

D. Newton and K. Fouseki

Balancing cultural and environmental values in buildings refurbishment.....539

J. Mourão and V. Campos

Character defining elements549

P. Eriksson

Heritage, social values and the threat of ruination.....557

T. van der Schoor

Nearly Zero Energy Heritage567

G. Franco

Day 2 – Joint session

Energy efficiency improvement in historic urban environments.....576

Egusquiza, J.L. Izgara and A. Gandini

Preface

We proudly present the postprints of **the third International Conference on Energy Efficiency in Historic Buildings**, held in Visby, Sweden September 26th to 27th, 2018.

The conference was organized jointly by the Swedish Energy Agency, Uppsala University and the Swedish National Heritage Board as part of their collaboration in the Swedish national research program on energy efficiency in historic buildings. The Region of Gotland kindly sponsored the conference dinner.

There were close to one hundred abstracts submitted to the conference. We gratefully acknowledge the contributions from the Scientific Committee in the review process.

Our thanks to Lisa Nilsen who has been the conference coordinator and editor of the papers, Susanna Carlsten who has been in charge of information and conference planning and Alice Sunneback who finished the layout of the papers and the report as a whole.

The organizing committee for EEHB2018

Tor Broström
Uppsala University

Jörgen Sjödin
Swedish Energy Agency

Camilla Altahr-Cederberg
Swedish National
Heritage Board

Understanding the change of heritage values over time and its impact on energy efficiency

Decision-making at residential historic buildings through system dynamics

K. Fouseki and Y. Bobrova

Institute for Sustainable Heritage, Bartlett School of Environment, Energy and Resources, University College London (UCL), London, UK.

Abstract – This paper explores how cultural meanings attached by home owners to traditional listed or non-listed buildings conflict with their need for thermal comfort. The paper further examines how this tension influences residents' renovation decisions regarding cultural features of a house. System dynamics are used in the paper for the analysis of in-depth, semi-structured interviews carried out with fifteen households located at the Local Borough of Waltham Forest in London. The paper concludes with a dynamic hypothesis of how home owners' priorities change over time. It is shown that residents tend to appreciate the cultural value of original features at the time of purchasing an old building. However, as they settle into their new places, it becomes evidently more important for them to provide comfort for their everyday life, including thermal comfort and reduction in energy bills. The priority is again shifted towards cultural values and heritage preservation when the wider surrounding market puts a high economic value on cultural features of a house.

Keywords – heritage values; historic buildings; system dynamics; energy efficiency; thermal comfort

1. INTRODUCTION

The tension between thermal comfort and cultural meanings (often referred to as heritage values in the heritage literature) assigned by residents of historic dwellings has been widely recognised both in academia and policy. However, what drives this tension and how this tension manifests itself over time is less well understood [1] [2]. To address this tension and enable the preservation of original features, national heritage organizations (such as Historic England) and European endeavours (such as the European Standard [EN 16883:2015] Guidelines for Improving the Energy Performance of Historic Buildings) have provided guidance for balancing energy efficiency interventions and heritage preservation. However, such guidance is not necessarily reaching those who ultimately inhabit and manage historic dwellings and are not taking into account future change of values and technological developments.

Since, as we would like to argue, heritage is a dynamic and a complex socio-technical system that comprises of interlinked physical and cultural dimensions which change over time (such as materials, values and meanings, stakeholders and decision-makers, the wider cultural and political landscape), socio-technical,

systemic methods capturing this change need to be integrated into heritage research. We argue that system dynamics can offer a suitable method for exploring the dynamic and complex interrelationship of factors that drive decision-making processes. It is therefore the aim of this paper to examine through system dynamics how cultural meanings, associated with notions of authenticity and aesthetics, change over time in the context of residential historic buildings, and what the impact of that change is on energy efficiency interventions. We do this by analysing 15 semi-structured interviews with tenants and homeowners of traditional listed or non-listed buildings in one of the most deprived boroughs of London – Waltham Forest. Given the limited uses of this method in the context of heritage, this paper attempts to provide a detailed presentation of the method alongside the results.

2. SYSTEM DYNAMICS AND CRITICAL SYSTEMS THINKING

The term ‘system’, in system dynamics, refers to a set of things and/or people interconnected in such a way that they produce their own pattern of behaviour over time [3]. The method of system dynamics is underpinned by the theory of systems thinking. Systems thinking is underscored by the idea that events and patterns, or things that we observe, are driven by systemic structures and hidden mental models [4]. Systems thinking is, in other words, about understanding the interconnection and systemic structure of elements that form a whole [5].

Systems in systems thinking have traditionally (and rather problematically we would argue) been distinguished between ‘hard’ and ‘soft’ systems [6]. ‘Hard systems’ refer to the technical operations of a system, while ‘soft systems’ signify systems in which human beings play an important part [7]. Initially, systems thinking prevailed in hard systems approaches back in the 1960s, such as operation research, system analysis, and systems engineering. In the 1970s, hard systems approaches were challenged by new developments in soft systems thinking [8] acknowledging the role of people in the operation of systems, but failed to deal with critical issues of power and social change [9].

The lack of engagement of soft system approaches with critical issues led to the emergence of critical systems thinking during the 1980s [10]. Critical Systems Thinking is committed to question the methods, practice and theory and committed to pluralism insisting that all system approaches, either hard or soft, have a contribution to make. Our analytical approach aligns with principles of Critical Systems Thinking in that we have been critically debating and questioning our analytical approach, constantly being aware of the need to improve policies and communities through our results and adopt a pluralistic methodological approach combining qualitative and quantitative tools. Indeed, due to the restrictive size of this paper, we have developed a lengthy paper that will be submitted to a peer-reviewed journal, outlining the critical and analytical approach that we debated during the process. However, in this paper we point out some of the key challenges that we faced and debated during the analytical process.

3. METHODOLOGY

The first step in system dynamic analysis is identifying the *problem* under examination. This is followed by defining the *system's boundaries* – that is the identification of those parameters that are viewed as critical for the change of the system. The next step is to create a matrix of causes and effect relationships which will graphically be presented into a *dynamic hypothesis* and represented via a suitable software (we have used Vensim in this paper) in the form of a *causal-loop diagram*. The *causal-loop diagram* provides the basis for developing the *stock-flow diagram*, which is essential for the development of the *system dynamics model* (fifth step). The *stock-flow diagram* represents the *stocks* and *flows* of the system or, in simple words, it represents *what* accumulates over time and *what* drives this accumulation. Each relationship between *stocks* and *flows* is described with simple mathematical equations [11] in order to enable the simulation of the dynamic hypothesis created (sixth step). This has indeed been one of the most challenging steps for us. How can (or should even) abstract concepts – such as that of cultural meanings – be represented via mathematical equations? After lengthy debates and discussions (and also due to the willingness and need to experiment in order to create a much needed, novel framework) it became apparent that the effort to represent the relationships of the different variables with simple mathematical equations, forced us to think even more about how these interrelationships behave (as explained below). Once the *dynamic hypothesis* or *system dynamics model* is created, the final step is to test and validate in the real-life context (seventh step).

As mentioned above, defining and articulating the problem caused by a complex and dynamic system is the first step in developing a *dynamic hypothesis* [12]. In our case, the problem that triggered the research question is the observed tension between thermal comfort and the preservation of original features in historic buildings. The problem was further refined by looking at the interview data with an 'open-eye'. In other words, interviews were coded through an *open coding* process, allowing the identification of themes and variables linked to the problem [13]. The identified variables were grouped into wider themes following an *axial coding* process. The *coding* facilitated the refinement of the problem under examination, the identification of the system boundaries and the mapping of the cause and effect relationships between the variables.

The boundaries of the system in our case studies consist of the building fabric, the home owners and the values/meanings they assign to the building. Once the interviews were coded, cause-effect relationships were identified and mapped on tables following the template developed by Kim and Anderson [14]. Identifying the cause and effect variables is the basis for creating a *causal loop diagram*. A causal loop diagram visualizes the *feedback loops* that are assumed to have caused the behaviour of key variables over time [15]. In other words, causal loop diagrams depict the causal links among variables with arrows from cause to effect [16]. Each cause-effect relationship is indicated with + or – depending on whether the relationship is positive and reinforcing (e.g. the more ... the more) or balancing (e.g. the more ... the less).

The system dynamic analysis of the interviews results is – what is known in system dynamics – a *dynamic hypothesis*. This is a hypothesis of how residents (mainly home owners) treat the dilemma between heritage preservation and energy efficiency over time. It is worth mentioning here that the proposed *dynamic hypothesis* presented in this paper requires validation and testing by sharing and discussing the hypothesis with the involved stakeholders (i.e. communities, policy-makers, etc.). Given that the research at this stage relies purely on qualitative, interview data, we incorporated a series of validity strategies including using analytical description of the context of the study; clarifying the biases that we both bring to the study through critical self-reflection; using peer debriefing, independent coding before discussing together, and an external auditor who is not familiar with the project but has expertise in system dynamics [17].

4. RESULTS

The *dynamic hypothesis* developed during the study can be summarised as follows: home owners tend to appreciate the cultural value of original features at the time of purchasing an old building. However, prioritization of cultural values, with which traditional buildings are originally imbued, declines over time as functional values associated with the need for thermal comfort and reasonable energy bills increase in significance. It is likely though that the decline of cultural values may be reversed when the wider surrounding market puts a high economic value on original features of a house – for instance when the market value of original features of traditional buildings increases in the area, especially when the area acquires conservation area status. This dynamic hypothesis is captured in the aggregate causal-loop diagram which demonstrates how cultural values (such as authenticity and aesthetics) associated with original features change over time (Figure 1).

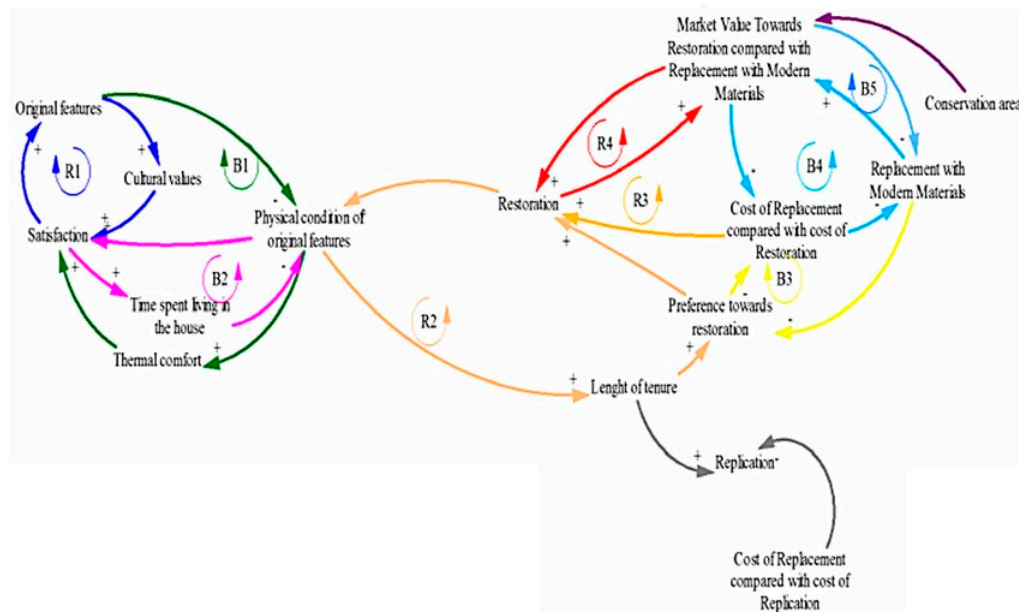

Figure 1. Aggregate causal loop diagram created on Vensim.

The first loop (R1) of the diagram is reinforcing that the *higher the number of original features*, the *stronger the cultural values* assigned to the building. Furthermore, the *stronger the cultural values*, the *more satisfied* the residents are with the overall house. As one of the interviewees stated “*They [original windows] are part of the fabric of the house and it was nice to keep the house as it was, as it was meant to work, you know it still had all the original weights and the cavities and, so yeah, you know, it was part of the soul of the house*” (Interviewee 1: Female, 40–45, housewife). However, over time, the residents experience the poor physical condition of the original features and its impact on thermal comfort, thus affecting their overall satisfaction with the house.

The balancing loop (B1) indicates that the *more the original features*, the *higher the risk of physical damage* and drafts and, thus the *lower the perceived thermal comfort* and *overall satisfaction* with the house. This loop reflects the problem in question, i.e. the dilemma between preserving the *original features* and replacing them with modern ones in order to improve the *thermal comfort*. (B2) takes into account the parameter of *time* as the more time spent living in the house, the more the residents realize the deteriorated physical condition of the house, and the lower their overall satisfaction.

The tension between *heritage preservation* and *thermal comfort* leaves the residents with three main options: a) restoration/preservation of original features; b) replacement of original features with modern features, and c) replacement of original features with replicas. Option b) is mainly adopted in the case of sash windows, while option c) occurs usually in the case of decorative features such as cornices or, sometimes, fireplaces. Final decisions will ultimately depend on the cost of restoration, the market preference in the surrounding area and the years the residents are planning to spend in the same house (length of tenure).

Indeed, there is a reinforcing interrelationship between the years that the residents are planning to stay in the house and their willingness to restore the original features (R2). According to this relationship, the *more the years they intend to stay*, the *more likely to restore*. As Interviewee 2 put it “*If I’d plan to stay here forever, but you know, if I plan to sell the house in a short to mid-term there was no point, if it’s my forever house yeah, but it’s, if it’s not house I’m planning to stay for a longer time then I won’t bother*”. (Interviewee 2: Male 45–50, restaurant owner). Options will also depend on the cost of replacing the windows in comparison with the cost of restoration (R3). According to the reinforcing loop (R3), the higher the cost of replacing the more likely to restore, and vice versa. An additional correlated factor is the type of area and the degree to which the market in the surrounding area values *original features*. This is of relevance for those home owners who intend to sell their property in the near future.

In sum, the *dynamic hypothesis* represented by the aggregate cause-loop diagram, is that cultural values associated with the original features of an ‘old’ house prevail at the early phase of purchasing an old building, but decline over time as the need for thermal comfort becomes more imperative. However, if the market in the surrounding area values the preservation of original features, or

if the house is located in a conservation area, then cultural values regain their importance. Home owners will choose to restore, replace or replicate original features depending on the type of feature, the physical condition and its impact on the perceived thermal comfort, the comparative cost of replacement, replication and restoration, the length of tenure and the market value in the wider area.

The next and possibly most challenging task was to model the interrelationships of the aforementioned factors and their change over time on Vensim software (Figure 2). As mentioned above in the methodology section, the core elements of system dynamics modelling is to model the interrelationship between *what accumulates over time* (stocks) and *what drives this accumulation* (flow). Figure 2 presents a small section of the model in order to depict the dynamic interrelationship between *what values and meaning increase over time* and *what drives this increase*. The terminology that we have used is conventional. We developed it together after consensus as one of the authors is a heritage scholar and the other a 'system dynamist'. We thus come from different epistemological backgrounds, which offered a fruitful ground for discussion and debate.

For clarity purposes, we explain the 'stocks' and the 'flows'. The section presented in Figure 2 shows an orange box. The orange refers to *the role that the original features play in enhancing the cultural value of the house*. In one word, we could define it as the **original significance** of the house. This is a 'stock' in system dynamic terms in the sense that it increases over time

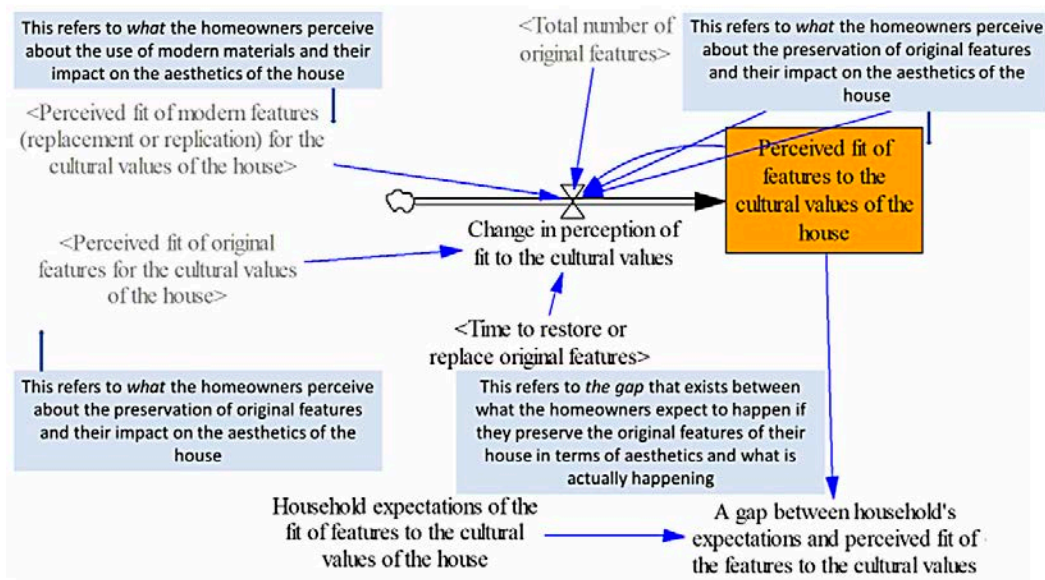

Figure 2. This figure presents a very small section of the model. The orange box is the 'stock', i.e. what accumulates, changes over time (in this case we have the example of cultural values associated with aesthetics as they are enhanced by the preservation of the original features of the house). The 'flow', i.e. what drives a change, is depicted in the middle by an arrow. The text in the blue boxes provides a short explanation for each variable.

till an event occurs (such as the physical deterioration of the original features) that leads to its decrease. Indeed, the 'flow' which refers to *what drives the accumulation or change over time*, is depicted with an arrow in the middle of the diagram. We have used an abbreviation phrase, i.e. *change of the perception of the residents that the original features do actually enhance the cultural significance of their building*. We have inserted an explanatory note on the diagram to make this illustration clearer. As mentioned in the methodology section, in order to enable the simulation process of how the dynamic interrelationship between two variables changes over time, mathematical equations are needed. This was the most challenging aspect, especially for the heritage scholar, as it was difficult to conceptualize on how the aesthetic value with which the original features attributed can be represented by a number or an equation. However, as we acknowledge that a historic house is a socio-technical, dynamic system, we decided to experiment and through critical discussion elaborate on what a model or a mathematical equation actually does and does not. In our selected section presented in Figure 2, the 'perceived fit original features to the cultural values' is an abbreviation that we used in order to connote our finding that the homeowners attach originally an aesthetic value to the house if it preserves the original features. In other words, the homeowners view the original features as aesthetically pleasant, a value that closely links to the visual aesthetics. Hence, for abbreviation purposes and to make the model workable, the equation that represents the orange box (stock) of this aesthetic value associated with the original features, was conventionally named 'visual points'. It is important to note at this stage how conversations between an interdisciplinary team need to be recorded as the actual content of the abbreviations may be forgotten in due time. Once we decided the name of the equation, we had to assign a numerical scale in order to generate the simulation. This provoked an additional heated debate on how to assign a numerical scale. Aesthetic values cannot be measured with numbers, or could they? We concluded that the scale again is only a tool that we use in order to map numerically the change that will enable the simulation. We noted from the interviews that the home owners attached a very high value to the originality of the house as they thought it enhances the aesthetics – hence, if we could represent this on a scale between 1 and 10, for example, the value could be 10. Over time, thermal comfort across the spectrum of a scale between 1 and 10 gains priority over the original features. Hence, the initial value of aesthetics (or visual points as we have conventionally called them) declines while the thermal comfort increases. We obviously do not have data on how much it declines since we did not do carry out quantitative questionnaires with Likert scale questions. We thus acknowledge this limitation. However, we can we still represent on scale that 10 represents the highest importance, 0 the no importance, and 5 the medium importance.

Figure 3 shows an example of the simulation testing the developed hypothesis. The simulation that we run shows how the need for thermal comfort (we conventionally name it thermal points) declines or increases over time versus the aesthetic values (we conventionally named it visual points).

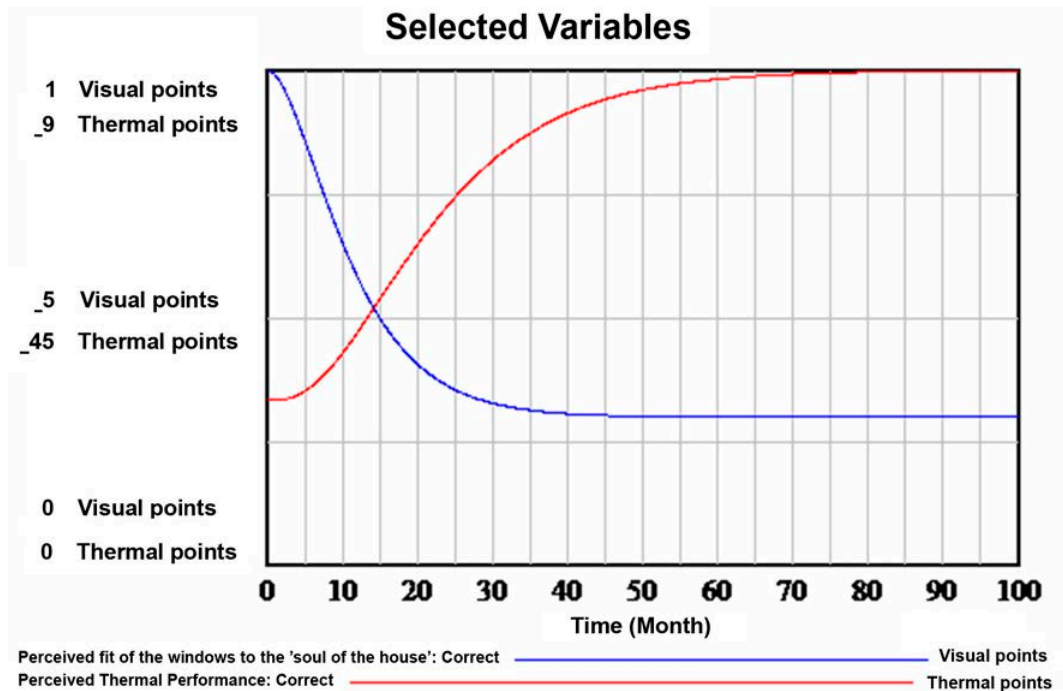

Figure 3. An example of simulation which shows how the need for thermal comfort (conventionally named as 'thermal points') increases over time while the priority over the original features that enhance the aesthetics and other cultural values of the house (conventionally named as 'visual points') declines over time.

Finally, as can be seen by the *stock and flow* diagram in Figure 3, there is a gap between what the owners perceive and how they expect the original features (with special reference to the sash windows) to perform from a thermal point of view. This gap creates a desire to change the current condition which results from the difference between the initial household's expectations and the perceived fit of windows to fit the aesthetic values. The desire to change the visual conditions of the house will emerge by the gap that exists between the residents' expectations of the contribution of the windows to the aesthetics and other cultural values with which the house is imbued (for instance, almost all interviewees made reference to how the original features were part of the 'soul of the houses'). The larger the gap, the larger the desire to change the visual conditions.

5. CONCLUSION

In this paper we introduced the application of system dynamics in heritage management studies and we developed a dynamic hypothesis regarding the change of cultural values with which residential historic buildings houses are attributed over time. We demonstrated that homeowners of traditional, listed or non-listed buildings, assign at the point of purchase high cultural values at their residence if it preserves most of its original features which then decline over time as the need for thermal comfort and affordable energy become their major priority. However, this decline may be reversed if the market value of cultural features of a house increases in the surrounding area.

More importantly, this study is an experimental, albeit challenging, effort towards socio-technical studies on complex and dynamic systems, such as that of heritage. Testing the applicability of a methodological tool that emerged from within 'hard sciences' was definitely a challenge. Despite its limitations and challenges – with the main one being to quantify abstract concepts such as that of values – the application of system dynamics forced us to think of the tension between heritage preservation and thermal comfort in a complex and dynamic way by addressing the issue of change over time. It also enabled us to better understand that the way homeowners and tenants act is determined by the gap that exists between *what they perceive* is happening or is important and *what is actually happening*. It takes time for the homeowners to realize this gap and once they do, they undertake interventions depending on other factors such as cost, practicalities and trends in the wider neighbourhood.

As change itself is a system and complex process, we would like to advocate for more research in this area that will allow development of a heritage dynamics theoretical and methodological framework that will enable heritage managers and researchers to study and manage sustainably heritage change. We also want to stress that this type of studies require very close and time-consuming collaboration between different experts, not only because a shared terminology and understanding needs to be developed but also – and more critically – because the analytical, conceptual and methodological process needs to be debated, discussed and reflected.

Our proposed *dynamic hypothesis* has significant implications for current policy and practice guidance on energy efficiency in historic buildings. Current guidance fail to encapsulate the complex and interconnected values with which historic dwellings are imbued and the dynamics of those values. For instance, the evolvment of cultural values into economic values over time can have significant impacts (positive and negative) on the type of energy efficiency interventions that homeowners adopt.

Our paper is only the starting point for opening up a wide array of questions around the widely acknowledged tension between energy efficiency and heritage preservation. It instigates a series of areas for further research, both for system dynamic and heritage management researchers. Firstly, the field of system dynamics must certainly address the relationships between qualitative mapping and quantitative modelling – in short, when to map and when to model, as well as how to model (especially qualitative data). To advance in this area, the field requires both academic research and reflective, constructively self-critical practice. More research is also needed on merging system dynamics with other approaches in order to capture decision-making behaviour of more than one individual. In addition, more heritage-related studies are needed to integrate qualitative and quantitative data into the system analysis.

The next steps of our research are to test and validate the *dynamic hypothesis* in different geographical and cultural contexts. We also intend to discuss the system dynamics model with key heritage policy-makers and heritage practitioners in

order to test its relevance and applicability. Since one of the main applications of system dynamics is to inform, design and evaluate policies, our next future research stage is to also examine the impact of current heritage conservation policies and guidance on decisions made by the residents on energy efficiency. A longitudinal study that explores decision-making processes over a period of time combining measurable, quantitative data associated with the building and energy performance of historic houses with qualitative data, will be extremely enlightening in terms of how perceptions differ from what is actually happening and how this gap between the *perceived* and the *actual state* of a phenomenon drives certain decisions.

6. REFERENCES

- [1] K. Fouseki and M. Cassar. (2014) "Editorial: Energy Efficiency in Heritage Buildings: Future Challenges and Research Needs". The Historic Environment, [Online] 5 (2), pp. 95–100, <https://www.tandfonline.com/doi/full/10.1179/1756750514Z.00000000058> [Jan. 21, 2017].
- [2] F. Berg, A. Flyen, A. Godbolt and T. Broström (2017) "User-driven energy efficiency in historic buildings: A review". Journal of Cultural Heritage [Online] Available: <https://www.sciencedirect.com/science/article/pii/S129620741730362X> [Dec.20, 2017].
- [3] D.H. Meadows. Thinking in systems: A primer. Chelsea Green Publishing, 2008.
- [4] P. Checkland. "Systems thinking" in Rethinking Management Information Systems: An Interdisciplinary Perspective, W. Currie and B. Galliers Eds. Oxford: Oxford University Press, 1999, pp. 45–56.
- [5] J.P. Monat and T. F. Gannon (2015) "What is Systems Thinking? A review of selected literature plus recommendations" American Journal of Systems Science 4 (1), pp. 11–26.
- [6] P. Checkland. "Systems thinking" in Rethinking Management Information Systems: An Interdisciplinary Perspective, W. Currie and B. Galliers Eds. Oxford: Oxford University Press, 1999, pp. 45–56.
- [7] M.C. Jackson (1991). "The origins and nature of critical systems thinking". Systems practice, 4(2), pp. 131–149.
- [8] D. Schechter. Critical systems thinking in the 1980s: A connective summary in Critical Systems Thinking: Directed Readings. Wiley: Chichester, 1991, pp. 213–227.
- [9] M.C. Jackson (1991). "The origins and nature of critical systems thinking". Systems practice, 4(2), pp. 131–149.
- [10] M.C. Jackson (1991). "The origins and nature of critical systems thinking". Systems practice, 4(2), pp. 131–149.
- [11] E.F. Wolstenholme. System enquiry: a system dynamics approach. John Wiley & Sons, Inc., 1990.
- [12] L.F. Luna-Reyes and D.L Andersen (2003) "Collecting and analyzing qualitative data for system dynamics: methods and models". System Dynamics Review, 19(4), pp. 271–296.

- [13] A. Strauss and J.M. Corbin. *Basics of qualitative research: Grounded theory procedures and techniques*. Sage Publications, Inc. 1990.
- [14] H. Kim and D.F. Andersen (2012). "Building confidence in causal maps generated from purposive text data: mapping transcripts of the Federal Reserve". *System Dynamics Review*, 28(4), pp. 311–328.
- [15] J. Randers. Ed. *Elements of system dynamics method*. Wright Allen Pr. 1980.
- [16] J.D. Sterman. *Business dynamics: systems thinking and modeling for a complex world* (No. HD30. 2 S7835 2000). 2000.
- [17] J.M. Morse, M. Barrett, M. Mayan, K. Olson and J. Spiers (2002). "Verification strategies for establishing reliability and validity in qualitative research". *International journal of qualitative methods*, 1(2), pp. 13–22.

Energy savings due to internal façade insulation in historic buildings

E.J. de Place Hansen and K.B. Wittchen

Danish Building Research Institute, Aalborg University Copenhagen (AAU Cph), Copenhagen, Denmark. Email: ejp@sbi.aau.dk; kbw@sbi.aau.dk

Abstract – Historic buildings contribute heavily to the energy consumption of the existing European building stock. Application of internal insulation offers a possibility to improve the historic buildings' energy performance, without compromising the buildings' architectural appearance.

The paper presents desktop analyses of potential energy savings in historic buildings, carried out using standard boundary conditions for calculation of energy savings, as prescribed in the European building energy performance certification schemes.

Internal insulation of the building's façades can potentially reduce the theoretical energy demand for space heating by 9 to 43 % compared to the energy demand of the original building if installed moisture-safe. Combined with other commonly used energy saving measures, 43–78 % reduction of the energy demand was estimated. This shows that internal insulation of external walls have the potential of contributing considerable to the overall energy savings in historic buildings and highlights the need for such measures.

Keywords – energy savings; historic buildings; internal façade insulation; case study; desktop analysis

1. INTRODUCTION

In order to comply with the 2050 EU decarbonisation agenda reducing considerably the CO₂ emission caused by energy use in buildings [1], renovation of the existing building stock is required. This includes historic buildings with architectural and cultural value, as they comprise 30 percent of the European building stock [2]. Application of internal insulation to external façades of historic buildings offers a possibility to considerably improve energy performance and indoor thermal comfort, without compromising the architectural appearance of the building. As part of the RIBuild project (Robust Internal Thermal Insulation of Historic Buildings) [3], assessment of the energy saving potentials related to renovation measures including internal insulation are carried out as desktop calculation exercises in some exemplary historic building cases that has recently been renovated and at present are being monitored. A number of scenarios are involved, depending on the degree of renovation before implementing internal insulation. This paper is based on calculations of buildings' energy demand for the following situations:

- as it was originally constructed;
- with implementation of internal façade insulation on the original building;
- with a package of energy saving measures often made in addition to internal façade insulation, e.g. new windows, roof insulation, under-floor insulation, etc.

Historic buildings do often have a long list of previous interventions that may have influenced the energy performance of the building. Additionally, detailed information on the building and its constructions, which are need for carrying out an energy performance calculation, or even more demanding an energy performance simulation, may not be available. Therefore, energy performance calculations were based on available information about the building materials. Standard conditions has been used for domestic hot water, internal loads (persons, light and equipment), internal temperature, external climate, etc. The effect of internal insulation on façades is challenged by the presence of partitioning walls and horizontal divisions that makes it impossible to insulate those parts of the façade covered by these constructions. This both limits the available area for application of insulation and creates thermal bridges in the internally insulated building.

Calculations of energy savings have been carried out using the national energy performance tool of the countries involved, [4] (Denmark), [5] (Latvia), [6] (Italy), and [7] (Switzerland). In most cases, calculations were based on quasi-stationary monthly conditions in accordance with EN ISO 13790 [8]. These calculation tools are based on the European package of standards for calculating energy performance of buildings for both new and existing buildings and thus not subject for literature scrutiny. One Danish case is described in detail in Section 2, the other cases are summarised in Section 3. In all cases internal insulation has been implemented by the building owner before RIBuild got involved. In several cases alternative, comparable solutions for internal insulation have been considered by the building owner before the renovation. These were included in the case study calculations of energy savings. The full set of information on the calculations are available in [9]. Results from monitoring the hygrothermal conditions will be analysed within another work package of RIBuild.

2. A DANISH CASE STUDY

2.1 PRECONDITIONS

Three Danish cases have been calculated using the Danish compliance checking tool: Buildings energy demand 2015 (Be15) [4]. Be15 is a calculation tool based on quasi-stationary conditions, and programmed according to EN ISO 13790 [8]. Be15 calculates energy demands in primary energy, and to avoid influence of the Danish primary energy factors, which is hard-coded into the tool, direct district heating is selected as heat source. This implies a primary energy factor of 1.0 and no losses (100 % efficiency) in the heating installation. All pipes and pumps used for distribution of heat and hot water inside the building have been removed from the calculation models. Additionally, the net energy demand is

being calculated for the habitable sections of the building only – the ground floor is occupied by shops. It is estimated that the energy demand is approx. 10–15 % higher if losses and efficiencies in the technical installations are included in the calculations.

Standard use of the buildings is assumed, i.e. standard load from persons, light, appliances and consumption of domestic hot water according to Table 1. The Danish design reference year [10] is used as climate data in the calculations with the following characteristics given in Table 2. In each case energy savings are calculated based on three different insulation measures, representing the different measures applied in the three case buildings.

Table 1. Standard values per m² gross heated floor area for internal loads in Danish case study calculations

System	Internal load
Persons	1.5 W/m ² (24 hours/day all year)
Appliances and light	3.5 W/m ² (24 hours/day all year)
Domestic hot water	250 l/m ² per year, heated from 10 °C to 60 °C

Table 2. Danish design reference year climate characteristics

Climate information	Data
Average outdoor temperature	7.75 °C
Minimum outdoor temperature	-21.1 °C
Maximum outdoor temperature	32.1 °C
Heating degree days (base 17 °C)	3940 HDD
Annual solar irradiation on horizontal	1025 kWh/m ²

2.2 CASE: THOMAS LAUBS GADE 5

2.2.1 Description before and after renovation

Thomas Laubs Gade 5 in Copenhagen is a 4-storey residential building from 1899. An apartment on the 4th floor has been internally insulated at the east-facing façade towards the street, cf. Figure 1.

The building was made with façades of bricks and presumably lime mortar. Façades are solid walls, thickness 1½ brick (350 mm) at 4th floor and 2 bricks (470 mm) at lower floors.

In the calculations and the experiment setup, the accessible area of the internal façade in the selected apartment is internally insulated with 30 mm PUR-foam with channels filled with capillary active material (termed '*PUR-foam based*' in this paper) covered by 10 mm gypsum board, having a total thermal resistance equal to 1.04 m²K/W – almost reducing the transmission loss through the insulated

parts of the façade by 60 % of the original value. The U-value of the walls at the upper floor after internal insulation is thus changed from 1.49 W/m²K to 0.59 W/m²K, and at the lower floors from 1.19 W/m²K to 0.53 W/m²K (Figure 2).



Figure 1. Thomas Laubs Gade 5, with indication of renovated apartment. Photo: Tessa Kvist Hansen.

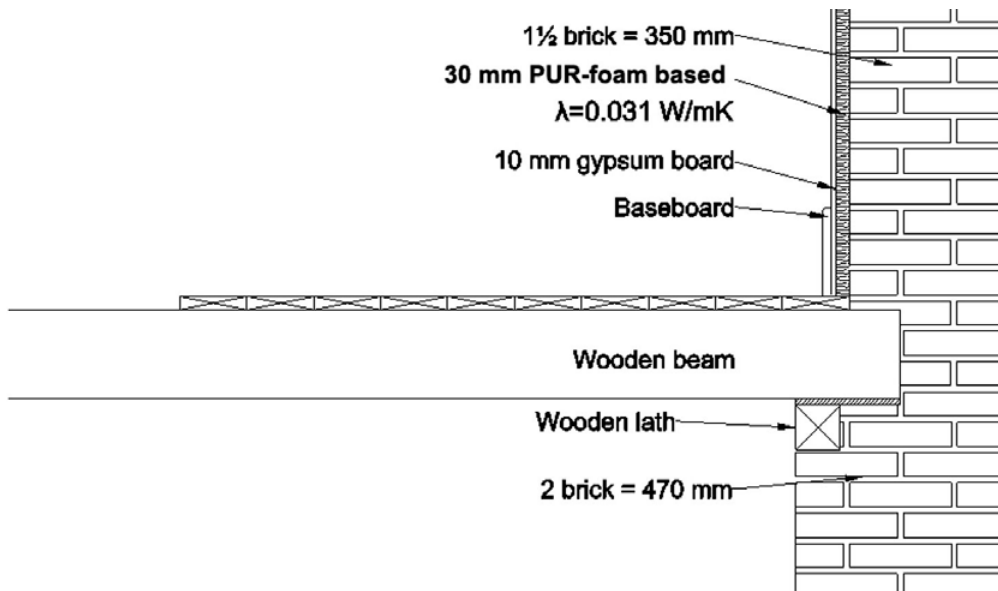

Figure 2. Section of internally insulated façade at Thomas Laubs Gade 5.

2.2.2 Calculation conditions

Calculations are only carried out for the upper three residential floors, assuming an adiabatic face between the shops and the apartments and towards the ends of the building. Due to internal walls and floors meeting the opaque façade, only a fraction of the façade can be insulated. In Thomas Laubs Gade 5, this means that only 51 % of the total façade area can be insulated (see Table 3).

Table 3. Overview of heated floor area and façade areas in Thomas Laubs Gade 5

Thomas Laubs Gade 5	m ²	%
Total heated floor area, 3 floors	273	-
Heated floor areas per floor	91	-
Total façade	161.9	100 %
Opaque façade	116.7	72 %
Insulated part of total façade	83.1	51 %
Windows	45.2	28 %
Not insulated part of total façade	33.6	21 %

2.2.3 Energy saving potential – results

As an experiment, alternative internal insulation systems were investigated in the calculations, i.e. 25 and 60 mm thermoset phenolic foam (termed '*phenolic foam*' in this paper) respectively, instead of the used 30 mm PUR-foam based internal insulation (see Table 4).

An often-seen energy saving measure in Denmark is blowing in insulation below the attic floor, which allows for approx. 60 mm insulation. This measure decreases the roof U-value from 0.45 W/m²K to 0.20 W/m²K, or a reduction of the transmission loss by approx. 55 %. Another typical measure in this type and age of building is to replace the original 1-layer windows with 2-layer windows, reducing the U-value from 4.4 W/m²K to 2.4 W/m²K or better (lower), normally done long time before considering installing internal insulation.

Table 4. Energy demands (and savings) due to selected internal insulation system and two alternative insulation systems in the building without other energy saving measures

As built	kWh/m ² heated area	PUR-foam based 30 mm kWh/m ²	Phenolic foam 25 mm kWh/m ²	Phenolic foam 60 mm kWh/m ²
Total energy requirement	129.5	108.7	106.6	100.1
Space heating	116.3	95.6	93.4	86.9
Domestic hot water	13.1	13.1	13.1	13.3
Savings (space heating)		17.8 %	19.7 %	25.3 %

In the building without additional energy saving measures applied, 30 mm PUR-foam based internal insulation results in 17.8 % savings. By replacing the windows and adding 60 mm attic floor insulation the energy demand for space heating is reduced from 116.3 to 80.5 kWh/m² heated floor area, or 31 %. By adding 30 mm PUR-foam based internal insulation in addition to this common package of energy saving measures, the total energy demand is 60.1 kWh/m², i.e. 48.3 % lower than for the original building.

Savings are calculated without considering the energy demand for production of domestic hot water as this is independent of the quality of the thermal envelope. Taking the standard consumption of domestic hot water into consideration (Table 1), energy savings drops to 16.1 and 43.5 % respectively.

The two alternative internal insulation systems, 25 and 60 mm phenolic foam, demonstrates that there are relevant alternatives to the selected internal insulation system and that a solution with 60 mm phenolic foam, upgraded windows and attic floor insulation result in 55.4 % energy savings on the space heating demand.

3. SUMMARY OF DANISH, LATVIAN, ITALIAN AND SWISS CASES

The study also included two other Danish cases (DK) and case buildings from Latvia (LV), Italy (IT) and Switzerland (CH), all summarised in Table 5. Danish case B is a four-storey residential building from 1905 situated in Copenhagen, similar to the case presented in Section 2 (case A), while Danish case C is a detached single-family house from 1875 located at the Northern shore of the island Zealand. The Latvian cases included a three-storey building with basement from 1910 built as a psychiatric clinic and since 1923 used as a Catholic school (Latvian case A), a one-storey public building from 1930, at present containing toilets and an exhibition room (Latvian case B), and a two-storey single-family house with basement from 1893 (Latvian case C), all from Riga. The Italian case is a three-storey single-family detached house built in 1935, located in a coastal town in the centre of Italy. The Swiss case is a six-storey residential building from 1910 situated in the centre of Lausanne.

In most cases U-values before and after renovation depend on floor level, as the wall thickness is lower at higher floor levels. Therefore, energy savings are calculated for each floor level and summarised to determine total savings. Additional energy saving measures typically includes replacement of windows, insulation of roof/attic and/or renewal of the heating system. Refer to [9] for details on cases and energy renovation measures.

Apart from Latvian case A and B, all cases are residential buildings: either multi- or single-family houses. In most cases, other measures had been implemented before internal insulation was installed, e.g. new windows or attic floor insulation, the latter being less complicated to install and therefore has a short payback period compared to internal insulation. Nevertheless, calculation of the individual energy savings was performed to make it possible to isolate the savings due to internal façade insulation from the other measures.

Table 5. Assessment of energy saving potentials in exemplary historic building cases from Denmark (DK), Latvia (LV), Italy (IT) and Switzerland (CH) based on two scenarios, one with internal insulation and one with both internal insulation and additional energy saving measures

Cases	DK-A	DK-B	DK-C	LV-A	LV-B	LV-C	IT	CH
Insulation material	PUR-foam based 30 mm	Phenolic foam 25 mm	PUR-foam based 100 mm	Mineral wool 50 mm	PIR 100 mm	Mineral wool 150 mm	EPS 60 mm	Aerated concrete 60 mm
Thermal conductivity [W/(m K)]	0.031	0.02	0.031	0.035	0.023	0.035	0.035	0.042
Average heating degree days	3940	3940	3940	4060	4060	4060	2165	3854
Average outdoor temperature [°C]	7.8	7.8	7.8	6.2	6.2	6.2	13.4	9.4
Heated floor area [m ²]	273	314	221	2410	65	339	288	1563
Insulated part of total façade (incl. windows and doors)	51 %	47 %	66 %	51 %	85 %	73 %	69 %	64 %
U-value of façade [W/m² K]								
Before renovation	1.19-1.49	1.19-1.49	0.62	0.78-0.89	1.23	2.14-2.52	1.76-2.58	1.60
After renovation	0.53-0.59	0.46-0.50	0.30	0.35-0.38	0.19	0.21	0.48-0.53	0.25
Reduction	58 %	64 %	52 %	55 %	85 %	91 %	77 %	84 %
Space heating [kWh/m²]								
Before renovation	116.3	125.5	112.3	171.6	564.4	194.4	213.0	141.3
+ internal insulation	95.6	103.7	97.0	156.6	383.8	125.8	141.5	79.8
+ additional energy saving measures	60.1	71.7	55.6	96.5	123.9	54.0	111.7	35.7
Savings (space heating)								
+ internal insulation	18 %	17 %	14 %	9 %	32 %	35 %	34 %	43 %
+ additional energy saving measures	48 %	43 %	51 %	44 %	78 %	72 %	48 %	75 %

The buildings' energy demand for space heating after application of internal façade insulation is reduced by 9 to 43 % compared to the energy demand in the buildings' initial state (as they were originally constructed) and the U-value of the façade is reduced by 52 to 91 %. A full renovation, will boost the energy savings to somewhere between 43 and 78 % compared to the buildings' original energy demand for space heating.

As expected, it helps to achieve high energy savings from applying internal insulation at the external wall if the building has a high amount of accessible area for such measure. However, the results also show that considerable energy savings can be achieved even in the case of a non-accessible façade, making up 50 % of the total façade area.

In all cases the energy saving measures included in the calculations are either implemented or planned to be. National requirements in Denmark, Latvia, Italy and Switzerland for thermal performance of buildings after renovation, do not necessarily request several measures to be implemented at once. In Denmark and Italy, requirements refer to specific components being renovated, e.g. windows or roof, while the Swiss Standard SIA 380/1 includes a global renovation limit [11]. Only a deep renovation scenario that also includes insulating the roof and the slabs, as well as changing the windows, will be able to reach the Swiss requirements.

4. DISCUSSION

Theoretical results from simulations like those summarised in Table 5 are not expected to provide the same savings as those measured in a renovated building. This is due to simplifications and standard assumptions in the simulations, e.g. system efficiencies, internal loads and domestic hot water usage, even though these may have changed in connection with the renovation. The calculation thus only analyses energy demands and savings for space heating due to upgrading of the building façade. Additionally, the real savings will, in most cases, deviate even more from the theoretical results, both due to standard assumptions about energy performance in the pre-renovated buildings overestimating the actual consumption, known as the prebound effect [12] and due to residents' tendency to improve the indoor climate in the renovated building, known as the rebound effect [13].

Internal insulation of the building façade is normally done in combination with or after implementation of other energy saving measures, i.e. the isolated effect of internal insulation is difficult to verify on real buildings. However, the results underline the great benefits solely deriving from application of internal insulation, provided this can be installed moisture-safe, i.e. without resulting in critical hygrothermal conditions in the building envelope increasing the risk of mould growth or frost damage. Whether this is the case is studied in other parts of the RIBuild project, not yet published.

Derived effects of insulation of façades such as improved indoor thermal comfort, e.g. improving the use of the indoor area close to the outer wall due to higher

temperature, often has more value for the user than the energy saving which should be taken into account when considering whether such a measure is cost-effective. Affordability of energy saving measures in the Italian case is presented in [14] but has not been part of this study. Furthermore, the results of the assessments performed, can be used as target points to perform Life Cycle Assessment “at building scale”, providing useful reference values to building designers, owners, stakeholders, etc.

5. CONCLUSIONS

Desk-top analyses of theoretical energy saving measures in selected historic case buildings in Denmark, Latvia, Italy and Switzerland showed the potential of using internal insulation, provided it can be installed in a moisture-safe way, i.e. without increasing the risk of mould growth, frost damage, etc. The case buildings’ energy demand for space heating was reduced 9–43 % solely due to installation of internal façade insulation, disregarding both the prebound and rebound effect. By combining internal façade insulation with other often-used energy saving measures, e.g. new windows, attic or basement insulation and/or renewal of heating systems, savings between 43 and 78 % were found.

The case studies show that application of internal façade insulation in historic buildings have the potential of considerably reducing the energy need for space heating also when considering insulation of the façades as a single measure. These achievements constitute an effective starting point for future developments, within not only RIBuild, but also in future projects in the field of energy savings in buildings and LCA improvements when renovating historical buildings.

6. ACKNOWLEDGEMENTS

RIBuild has received funding from the European Union’s Horizon 2020 research and innovation programme under grant agreement No 637268.

7. REFERENCES

- [1] European Union. Technical Guidance. Financing the energy renovation of buildings with Cohesion Policy funding, Brussels, 2014. Available: http://ec.europa.eu/regional_policy/en/information/publications/guides/2014/financing-the-energy-renovation-of-buildings-with-cohesion-policy-funding [Feb.1, 2018]
- [2] European Commission. Energy-efficient Buildings PPP. Multi-annual Roadmap and Longer Term Strategy, Brussels, 2010.
- [3] Robust Internal Thermal Insulation of Historic Buildings. Available: www.ribuild.eu [Feb. 1, 2018]
- [4] S. Aggerholm and K. Grau. Buildings energy demand – User’s Guide (In Danish). SBI Guideline 213. Danish Building Research Institute, Aalborg University. Copenhagen, 2016.
- [5] TRNSYS Type 56. Available: <http://www.trnsys.com/> [Feb. 1, 2018]
- [6] Italian software Termo Namirial, version 3.3. Software Certificazione Energetica–Legge 10. Available: <http://www.microsoftware.it/certificazione-energetica.asp> [Feb., 1 2018]

- [7] Lesosai software E4tech software SA. 2017. Available: www.lesosai.com/en/index.cfm [Feb. 1, 2018]
- [8] Energy performance of buildings—Calculation of energy use for space heating and cooling, EN ISO 13790:2008, Brussels: European Committee for Standardization, 2008.
- [9] E. di Giuseppe et al. Report and tool: Probability based Life Cycle Impact Assessment. RIBuild Deliverable D5.1, 2018. Available: www.ribuild.eu [Feb. 1, 2018]
- [10] P.G. Wang, M. Scharling, K.P. Nielsen, K.B. Wittchen and C. Kern-Hansen. 2001–2010 Danish Design Reference Year—Reference Climate Dataset for Technical Dimensioning in Building, Construction and other Sectors, Copenhagen: Danish Meteorological Institute, Technical Report 13–19, 2013.
- [11] Heizwärmebedarf, SIA 380/1:2016, Société Suisse des Ingénieurs et Architectes, Zürich, 2016.
- [12] M. Sunikka-Blank and R. Galvin. “Introducing the rebound effect: the gap between performance and actual energy consumption”. *Building Research and Information*, vol. 40, no. 3, pp. 260–273, 2012.
- [13] R. Galvin. *The Rebound Effect in Home Heating. A guide for policymakers and practitioners*. London and New York: Routledge, 2016.
- [14] E. di Giuseppe, M. Iannaccone, M. Telloni, M. D’Orazio and C. di Perna. “Probabilistic life cycle costing of existing buildings retrofit interventions towards nZE target: Methodology and application example”. *Energy and Buildings*, vol. 144, pp. 416–432, 2017.

Outlining a methodology for assessing deterioration threshold criteria

Linked to retrofitting historical buildings with internal insulation

L. Lång¹, P. Johansson¹, C-M. Capener¹, H. Janssen², J. Langmans², E. Møller³, M. D’Orazio⁴ and E. Quagliarini⁴

¹ RISE (Research Institutes of Sweden), Build Environment – Building Technology, Borås, Sweden. Email: carl-magnus.capener@ri.se; pernilla.johansson@ri.se; lukas.lang@ri.se

² KU Leuven, Department of Civil Engineering, Building Physics Section, Leuven, Belgium. Email: hans.janssen@kuleuven.be

³ Aalborg University, Danish Building Research Institute (SBI), Department of Building Technology and Management, København, Denmark. Email: evm@sbi.aau.dk

⁴ Università Politecnica delle Marche, Department of Construction, Civil Engineering and Architecture (DICEA), Ancona, Italy. Email: m.dorazio@univpm.it

Abstract – This paper describes a methodology for assessing damage threshold criteria as a part of the ongoing EU Horizon2020 project RIBuild. In RIBuild, effective, comprehensive decision guidelines are developed to support energy retrofitting of historical buildings with internal insulation without compromising their architectural and cultural values while maintaining an acceptable safety level against deterioration.

The methodology includes a survey and determination of threshold values for deterioration, which can then be used to evaluate the risk in specific structures of external walls. The work includes summarizing existing knowledge and adapting and developing models for failure modes based on field and laboratory testing.

Failure modes include frost damage of the exterior façade layer, rot and mould growth within the building envelope and adjoining structures, as well as discolouring of façade surfaces due to biological growth.

Keywords – internal thermal insulation; renovation; failure modes; historical buildings; energy retrofit

1. INTRODUCTION

1.1 ENERGY CONSUMPTION IN HISTORIC BUILDINGS

30 percent of the European building stock consists of historic buildings, which in the EU stand for more than one third of the total energy consumption from buildings [1]. It shows the importance of improving the energy efficiency of historic buildings.

It is possible to reduce the energy consumption in historic buildings by 15–20 percent [2]. One key action is to install internal insulation without impact on the outer façade. This is however followed by a risk of failures in the wall

construction, related to the function, the aesthetics and possibly the indoor air quality – all associated with high costs. Therefore, there is a need of more knowledge and guidelines on how to, in an effective and secure way, install internal insulation in historic buildings.

1.2 RIBUILD PROJECT

The EU Horizon 2020 research project RIBuild stands for Robust Internal Thermal Insulation and revolves around developing guidelines on how to apply internal thermal insulation in historic buildings of masonry and stone without changing or affecting the outer architectural and cultural values.

The main purpose of the RIBuild project is to enable a reduction of the energy consumption in historic buildings to reach the EU 2020 climate and energy targets.

RIBuild is a five-year project and will be finalized in the end of 2019. The developed guidelines will include an assessment determining whether a building is suitable for internal insulation or not, based on identified failure modes and available damage models as defined below.

1.3 BUILDING ENVELOPES HEAT AND MOISTURE TRANSPORT

Internal insulation in historical buildings does not only decrease the transmission losses through the thermal envelope, it also changes the hygrothermal condition in the existing masonry wall. Depending on for instance the insulation thickness, heat conductivity, porosity and permeability of the added material, the existing hygrothermal conditions in the wall will be affected in different extent. The insulation generally lowers the temperature, reducing the drying of the wall, and hence increases its overall humidity. Using transient simulation models for assessing hygrothermal conditions over time, i.e. temperature and moisture inside the wall structures, the output can be directly used for evaluating the risk of the different failure modes described in this report.

To evaluate the risk of different failure modes, transient hygrothermal simulations, including solar radiation and rain, must be used. Results from the simplified steady-state Glaser method, which is not taking those into account, nor the capillary transport and the sorption capacity [3], is not giving results useful for a realistic evaluation of the failures.

1.4 IDENTIFIED FAILURE MODES AND BUILDING PARTS AT RISK

When additional insulation is put on the internal side of an outer wall of a building, the original wall structure will be colder and wetter. These changed conditions may also lead to higher risk of different failures. In the project we have identified four failure modes:

- mould growth on materials within the building structure;
- frost damage of the exterior façade layers;
- growth of algae and fungi on the façade surfaces;
- rot damage in wooden structures.

The first failure mode, mould growth, can affect the indoor environment and health of people in the building, while superficial growth on the façades primarily has aesthetic consequences. Initially, frost damage leads to aesthetic problems but may in a long term also give structural consequences. Rot damages affect the strength of the building, and the growth of the rot fungi may also affect the indoor air. The positions with high risk of failure in a wall that have been internally insulated, are illustrated in figure 1.

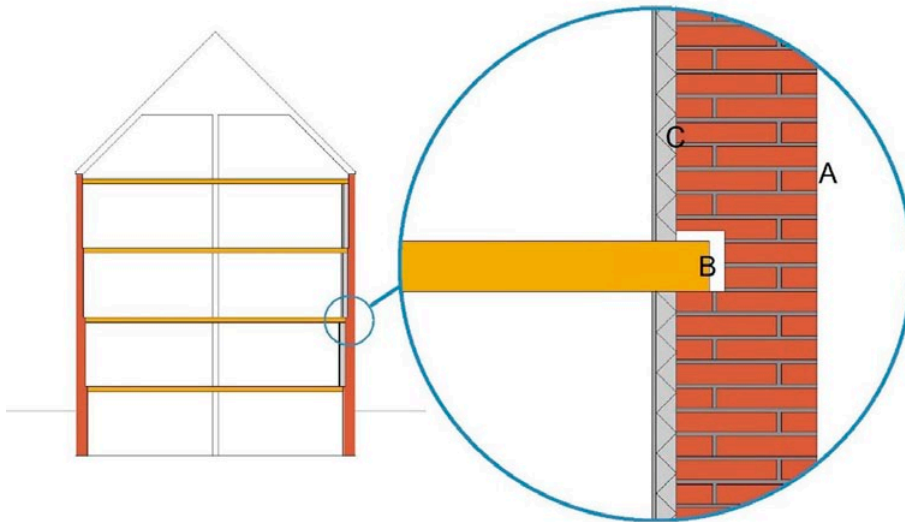

Figure 1. Parts of an exterior wall at risk of failure when installing internal insulation. (A) frost and discoloration of the façade surface, (B) rot in, and mould growth on, the beam ends, (C) mould and rot (if wood) on the interstitial materials surfaces and adjacent materials.

2. FAILURE MODES AND DAMAGE MODELS

2.1 DYNAMIC AND STATIC MODELS

Internal thermal insulation leads, as mentioned, to several risks of failures in the wall construction. To predict the failures, failure modes need to be known and different damage models should be used. Static models predict risk under constant conditions, while dynamic models also consider varying conditions present in buildings. These variations may affect the growth of algae, mould and rot fungi, as the growth rate is lower when conditions vary. Some species can survive dry periods and resume growth when conditions are favourable again. Frost damage is also highly dependent on varying conditions.

2.2 MOULD

Mould is a colloquialism for a range of microscopic fungi that share some common traits. They live on the surface of materials, produce airborne spores and use easy assimilated nutrients for growth. Mould acts as decomposers in the natural carbon cycle and their spores are found everywhere in the air and on various kinds of surfaces. When the right conditions are present, the spores germinate and grow to form a mycelium, and it is then that damage first occurs.

Conditions for mould growth include nutrient availability (primarily carbon sources), temperature, pH, moisture and duration of conditions. In general, the availability for water at the material surface is regarded as the crucial element for mould growth to occur. The susceptibility to mould growth of different building materials varies.

Growth inside a building is often not visible to the naked eye. Growth may also occur inside hidden parts of the building structure. Problems caused are therefore not always of an aesthetic kind. Neither does the growth affect the strength of the building structure. Instead, the negative effect of mould growth is linked to experienced indoor environment and possible negative health effects on people in the building.

There are several static and dynamic models for predicting mould growth, some are described and discussed in [4–6] from either measured data of RH and temperature or data from HAM-simulation (Heat, Air and Moisture) results. The results from the predicting models may be used to predict the extent of mould growth (e.g. as an index) or the possibility that there is risk for growth to appear at all. Each model has its pros and cons. In the project, prediction from different models will be compared to real outcomes in field studies.

2.3 FROST

Frost damage is mostly related to aesthetical problems when the frost is spalling the outer surface of the masonry wall. Where driving rain can infiltrate the masonry wall with internal insulation, the frost risk is moved further into the wall. The damage is due to a variety of mechanisms, including the volume increase of water when it changes to ice. The main parameters are the critical saturation degree and the critical freezing temperature. The temperature and saturation degree are both affected when internal insulation is added.

The models available for predicting frost damage together with results from a dynamic HAM-model, are listed below. It should be noted that the models only count the numbers of frost-thaw cycles or the time of exceedance of the two parameters mentioned above, hence not relating these solely hygrothermal indicators to the start or growth of the frost damage [7].

- Modified Winter Index (1)
- Amount of Frozen Water (2)
- Time of Freezing (3)
- Indicative Freeze/Thaw Cycles (4)

$$MWI = \sum_{i=1}^{8760} (T_L - T_i)(w_i - w_L) \quad [T_i < T_L \ \& \ w_i > w_L] \quad (1)$$

$$AFW = \sum_{i=1}^{8760} w_i \quad [T_i < T_L \ \& \ w_i > w_L] \quad (2)$$

$$TOF = \sum_{i=1}^{8760} 1 \quad [T_i < T_L \ \& \ w_i > w_L] \quad (3)$$

IFTC = number of freeze/thaw cycles $w_i > w_L$ (in which the freezing and thawing conditions hold at least 2 hours) (4)

w_i and w_L in the equations refer to the freezing temperature and the critical moisture content.

2.4 ROT FUNGI

A severe failure mechanism for wooden materials and constructions is rot or wood decay caused by fungal growth. This failure mode is closely linked to moisture as water activity is a prerequisite for fungal growth [8]. The most severe consequence of rot attack is the reduction of structural strength, but indoor air quality may also be affected.

The critical positions in the building envelope are where wood is present, and particularly where the moisture loads are high. In historic masonry façades, wood is mostly used for half-timbering in exterior walls. Wooden beam ends and supporting laths may be placed in the external walls, and are therefore in direct contact with bricks or stones. Also, if the building is internally insulated with systems that contain wooden materials, e.g. wooden framing, more wooden materials may become at risk of rot decay provided that the moisture level is high enough.

Rot fungal growth starts when the moisture content in wood exceeds a threshold value; this depends on different factors:

- duration of wetness, i.e. the time above the certain threshold value;
- condition of the wood; previously attacked wood has a lower threshold value; than non-affected wood;
- wood species;
- ambient temperature.

For most fungal species, the threshold value is in the over-hygroscopic range caused by condensation or liquid water sources from penetrating rain although there are some fungal species (dry rot) that can transport moisture over distances enabling rot attack far away from the moisture source. A prerequisite for dry rot is the presence of lime, which is often used in historic buildings and therefore present for the fungal growth. There are three types of rot fungi that can initiate decay in wood; brown rot, soft rot and white rot. Brown rot develops faster than other types of rot fungi, and is more likely to appear earlier than white and soft rot.

There are several mathematical models and assessment algorithms [9, 10] developed for predicting the risk of rot fungi and service life under dynamic conditions, all using governing environmental conditions such as moisture content and temperature for the wooden material as well as different material properties.

2.5 DISCOLORATION OF FAÇADES

When mould fungi grow on façades, they might cause discolouration. However, not all fungi cause this discolouration, only such species that contains dark pigmentation in their cells. In addition, algae and cyanobacteria growing on façades can cause discolouration. These microorganisms, like the fungi, need water to grow; in general, the lowest required moisture level for growth is higher. A big difference between the algae and cyanobacteria on one hand, and mould fungi on the other, is that the previous groups of microorganisms contain chlorophyll in their cells. In contrast, mould fungi lack this trait and are dependent on available nutrients within the material they grow on. Environmental factors are

therefore more crucial than the nutrient content of the material for algae to grow [11], while the contents of façade material may also have an important impact on the establishment of fungi. However, other characteristics of the materials may affect also the growth of algae and cyanobacteria, such as surface structure and porosity [12, 13].

3. FAILURE MODE THRESHOLD VALUES

3.1 THRESHOLD VALUES IN DAMAGE MODELS

To use the failure prediction models mentioned above, for the different failure modes, specific threshold values are needed. However, thresholds values are not widely established for all failure modes and materials, which makes it difficult or even impossible to evaluate all possible solutions and failure criteria. Within RIBuild we are currently working on how to reach consensus on these criteria.

3.2 MOULD

As mentioned above, building materials differ in their susceptibility for mould growth. Some materials tolerate being exposed to air with relatively high RH (> 95 %) without mould growth occurring, while on the most susceptible materials mould growth can appear at a relative humidity as low as 75 % RH [14–16]. The lowest relative humidity at which mould growth can be expected in a material can be described as the critical moisture value. This material property can be evaluated in laboratory tests [17–18]. With this laboratory test, each product and mark of a material gets its specific critical moisture value, and it is therefore not possible to provide general threshold values for different groups of materials [15, 20]. The threshold value may differ within a specific group of materials, and change with the development of a product. “If the critical moisture level is not well-researched and documented, a relative humidity (RH) of 75 % shall be used as the critical moisture level” [22].

3.3 FROST

The literature presents no threshold values for the mentioned frost models. Instead the frost models are mostly used on a relative basis comparing different solutions. The models are based on the critical moisture content, derived from the critical saturation level. Therefore, the indexes from the models are useful only if the critical saturation level is known for the specific material.

3.4 ROT FUNGI

Threshold values for rot fungi vary significantly between different studies [8, 10, 22] but some typical threshold values can be derived. Absolute threshold limits for temperature and moisture content are difficult to present, as temperature and moisture content are closely interconnected for fungal growth, and vary between fungi species. However, at temperatures lower than 5 °C the fungi are considered to be dormant and will not initiate any rot fungi growth. Similarly, an upper threshold limit for temperatures above 40–45 °C has been shown, whereas the ideal temperature is around room temperature dependent on fungi

species. Moisture content is of high importance, and sustained values close to or above wood fibre saturation can enable rot fungi to grow. Typically, such moisture contents are in the range of 25–30 weight-percent. Above certain moisture content (≥ 70 weight-percent) there is no rot fungi growth.

3.5 DISCOLORATION

As previously described, discoloration of façades can be caused by organisms such as mould fungi, algae and cyanobacteria. These have different threshold values for growth, but temperature and humidity are the most important environmental conditions, but exposures to pH and solar radiation also have an influence. The optimal temperature for algae and cyanobacteria lies between 10 °C and 40 °C. The organisms' resistance to high (above 50 °C) and low (below 0 °C) significantly varies from one organism to another. Optimum moisture conditions vary even more between different discoloration organisms. However, for green and blue algae, which are often the main cause of discoloration, liquid water is necessary. Algae and cyanobacteria can survive dry periods and growth continues when enough humidity is available again.

4. CONTROL ACTIONS

4.1 GENERAL CONTROL ACTIONS

An important control action is the pre-retrofit on-site investigation of the existing construction. Is there any pre-existing frost damage, ongoing leakage from driving rain, established mould or even rot? The choice of thermal insulation type and thickness must be considered when evaluating the proposed retrofitted construction.

General control actions to be considered:

- Estimating/calculating expected humidity and temperature conditions for the building material layers in the construction;
- Ensuring air tight mounting to circumvent additional moisture content leakage from the indoor air into the wall.

4.2 SPECIFIC CONTROL ACTIONS RELATED TO FAILURE MODES

- If possible, choose internal insulation materials and systems with higher threshold values for mould than the estimated conditions arising from the retrofit. Typical threshold values can be derived from laboratory testing and are already available for many materials;
- Possibly, a hydrophobic impregnation of the exterior surface can be beneficial to prevent moisture uptake, particularly concerning frost susceptible materials. A hydrophobic external surface may also inhibit certain algae species by reducing access to surface moisture;
- Choose clean, dry materials to eliminate additional building moisture. If storing material outdoors, use weather-proof covers to avoid excess moisture from precipitation.

5. DISCUSSION AND CONCLUSIONS

Part of the RIBuild project is to develop guidelines for assessing whether a building is suitable for internal insulation or not, based on identified failure modes and available damage models. Since many of the available damage models only give relative indications, evaluation must be carried out on a relative basis, particularly concerning failure modes such as frost damage and discoloration of façades. Consensus on acceptance levels for the different failure modes must be reached before serviceability limit state can be evaluated and the proposed measures assessed. For instance, is it possible to totally avoid mould growth in buildings? What would be an acceptable level of risk for different failure modes? If the mould is not too extensive and is not further growing, it may be accepted depending on the position in the building. Similar reasoning can be argued for the other failure modes.

6. REFERENCES

- [1] European Commission. "Energy-efficient Buildings PPP. Multi-annual Roadmap and Longer Term Strategy," E. Commision, Ed., ed, 2010, p. 18.
- [2] T. V. Rasmussen, "Retrofitting listed buildings: Measures, savings and requirements," *Open Construction and Building Technology Journal*, vol. 5, pp. 174–181, 2011.
- [3] H.M. Künzle, "Simultaneous heat and moisture transport in building components. One- and two-dimensional calculation using simple parameters", IRB-Verlag, pp. 102, 1995.
- [4] Å. Togerö, C. Svensson Tengberg, and B. Bengtsson, "m-model: a method to assess the risk for mould growth in wood structures with fluctuating hygrothermal conditions," presented at the Proceedings of Healthy Buildings, Espoo, 1: 317–22, 2011.
- [5] E. Vereecken and S. Roels, "Review of mould prediction models and their influence on mould risk evaluation," *Building and Environment*, vol. 51, pp. 296–310, 2012.
- [6] S. Thelandersson and T. Isaksson, "Mould resistance design (MRD) model for evaluation of risk for microbial growth under varying climate conditions," *Building and Environment*, vol. 65, pp. 18–25, 2013.
- [7] J. Kočí, J. Maděra, M. Keppert, and R. Černý, "Damage functions for the cold regions and their applications in hygrothermal simulations of different types of building structures," *Cold Regions Science and Technology*, vol. 135, pp. 1–7, 2017.
- [8] L. Boddy, "Effect of temperature and water potential on growth rate of wood-rotting basidiomycetes," *Transactions of the British Mycological Society*, vol. 80, pp. 141–149, 1983.
- [9] H. Viitanen, T. Toratti, L. Makkonen, R. Peuhkuri, T. Ojanen, L. Ruokolainen, et al., "Towards modelling of decay risk of wooden materials," *European Journal of Wood and Wood Products*, vol. 68, pp. 303–313, 2010.
- [10] H. Saito, K. Fukuda, and T. Sawachi, "Integration model of hygrothermal analysis with decay process for durability assessment of building envelopes," *Building Simulation*, vol. 5, pp. 315–324, 2012.

- [11] H. K. Tanaca, C. M. R. Dias, C. C. Gaylarde, V. M. John, and M. A. Shirakawa, "Discoloration and fungal growth on three fiber cement formulations exposed in urban, rural and coastal zones," *Building and Environment*, vol. 46, pp. 324–330, 2011.
- [12] L. Graziani, E. Quagliarini, A. Osimani, L. Aquilanti, F. Clementi, C. Yéprémian, V. Lariccia, S. Amoroso and M. D'orazio, "Evaluation of inhibitory effect of TiO₂ nanocoatings against microalgal growth on clay brick façades under weak UV exposure conditions", *Building and Environment*, vol. 64, pp. 38–45, 2013.
- [13] L. Graziani, E. Quagliarini and M. D'orazio, "TiO₂-treated different fired brick surfaces for biofouling prevention: Experimental and modelling results", *Ceramics International*, vol. 42, pp. 4002–4010, 2016.
- [14] W. Hofbauer, N. Kreuger, K. Breuer, K. Sedlbauer, and T. Schoch, "Mould resistance assessment of building materials – Material specific isopleth-systems for practical application," in *Indoor Air 2008*, Copenhagen, Denmark, 2008, Paper ID: 465.
- [15] P. Johansson, A. Ekstrand-Tobin, T. Svensson, and G. Bok, "Laboratory study to determine the critical moisture level for mould growth on building materials," *International Biodeterioration and Biodegradation*, vol. 73, pp. 23–32, 2012.
- [16] A.-C. Ritschkoff, H. A. Viitanen, and K. Koskela, "The Response of Building Materials to the Mould Exposure at Different Humidity and Temperature Conditions," in *Healthy Buildings 2000*, Espoo, Finland, 2000, pp. 317–233.
- [17] P. Johansson, A. Ekstrand-Tobin, and G. Bok, "An innovative test method for evaluating the critical moisture level for mould growth on building materials," *Building and Environment*, vol. 81, pp. 404–409, 2014.
- [18] SIS Swedish Standards Institute." Building materials – Laboratory method for assessment of the lowest hygrothermal conditions required for mould growth," SIS-TS 41:2014, 2014.
- [19] SP Technical Research Institute of Sweden."Laboratory Test Method for Determining Critical Moisture Level for Mould Growth on Building Materials," SP Method 4927, 2012.
- [20] P. Johansson, Determination of the Critical Moisture Level for Mould Growth on Building Materials vol. TVBH 1020: Byggnadsfysik, LTH, Lunds Tekniska Högskola, 2014.
- [21] BFS 2014:3. 2014. "Boverket's building regulations -mandatory provisions and general recommendations, BBR". Boverket Swedish National Board of Housing, Building and Planning.
- [22] P. I. Morris and J. E. Winandy, "Limiting Conditions for Decay in Wood Systems," presented at the Thirty-third Annual Meeting of the International Research Group on Wood Preservation, Cardiff, South Wales, UK, 2002.

How to estimate material properties for external walls in historic buildings before applying internal insulation

E.J. de Place Hansen and E.B. Møller

Danish Building Research Institute, Aalborg University Copenhagen (AAU Cph), Copenhagen, Denmark. Email: ejp@sbi.aau.dk; evm@sbi.aau.dk

Abstract – Before deciding how to improve the energy efficiency of historic buildings by applying thermal insulation, an estimation of consequences, e.g. changes in heat and moisture flux, must be made. When applying internal thermal insulation to external walls, estimations are most likely made by hygrothermal simulations, which require information on material properties. These could be determined by tests, but full testing can be comprehensive. Instead, the planner is more likely to use materials already included in the simulation tool. But how to choose the best material? In the EU-project RIBuild, attempts have been made to cluster historic building materials; enabling a user to choose an appropriate material and include uncertainties. Brick clusters were created based on material properties, all equally important. However, these input clusters differed from clusters based on output from hygrothermal simulations, indicating that not all material properties were equally important. Unfortunately, the decisiveness of properties depended on whether e.g. conditions at external or internal surface of the brick wall were considered.

Keywords – clustering; failure mode; historic building materials; internal insulation; material properties

1. INTRODUCTION

Historic buildings built before 1950 make up 30 percent of the European building stock [1], and are often poorly thermally insulated, but with architectural or cultural values, especially related to solid external walls. In these cases, the possibilities for external thermal insulation are limited. This calls for robust and permanent, reversible energy-efficient internal solutions, otherwise the building owner will not be motivated to initiate energy savings unless he is forced. However, no matter whether internal insulation is promoted voluntarily or mandatory, it should be based on scientifically based risk assessment and Life Cycle Analysis [2].

The aim of the EU-project RIBuild (Robust Internal Thermal Insulation of Historic Buildings) [3] is to ensure robust solutions with internal thermal insulation in historic buildings and to guide a building owner when he considers renovating such a building. The building owner needs to know how much internal insulation it is safe to apply to a solid external wall. In engineering practice today, simple calculation methods are often used to assess moisture risks; they require a minimum of material properties and boundary conditions, in some cases this

might be sufficient. In RIBuild, a solid external wall will be used as reference for hygrothermal simulations. Results of simulations, including different kinds and thicknesses of internal insulation added to the reference wall, will be compared to threshold values for different failure modes to determine whether the solution is sufficiently robust or not. However, to create a tool that enables this, several steps must be taken: defining the wall structure, choosing the simulation tool, determining material properties needed for simulation, as well as location and orientation of the wall, and defining threshold values for different failure modes. This paper focuses on material properties using bricks as case, being the most common material in external walls of historic buildings [4].

2. CLUSTERING OF BUILDING MATERIALS BASED ON MATERIAL PROPERTIES

2.1 AVAILABLE MATERIAL PROPERTIES

Several material properties are needed to fully describe the hygrothermal behaviour of historic building materials. Moisture transport in building materials depend on numerous hygric properties, other properties describe heat transport, and finally heat and moisture transport are interlinked. RIBuild has shown that complete sets of material data required by hygrothermal simulation tools like Delphin [5] or WUFI [6] are rare; for most specific materials, a set of data was complete only if the material was found in a database used by such a tool [7]. Furthermore, calibrated material functions are needed, i.e. test results should be further processed before they can be used in the simulation tool.

The question is how a building owner can decide whether one of the materials included in the simulation tool represents the material that his building is made of. Often only a few properties are known, e.g. density, water uptake coefficient or other properties that are easy to determine. However, a complete test of all material properties, although minimising the uncertainties, is expensive and time consuming. This is why RIBuild used clustering of materials; to group materials with similar material properties, i.e. materials having more in common with each other than with the remaining materials, expecting their hygrothermal performance to be similar as well. By placing a specific type of brick with only a few known material properties in a cluster of bricks, it is possible to estimate the missing properties. However, by performing simulations based on clusters, the outcome will include uncertainties, making it clear what is lost when the high cost of complete testing is saved.

2.2 INPUT CLUSTERING

Clustering was based on twelve material properties (input data) of 44 bricks where a complete set of material properties were available, including ten properties studied by Zhao et al. [8], [9] as well as bulk density and water vapour permeability (wet cup value). All properties were represented by single numbers; properties that are normally expressed by sorption isotherms and suction curves were represented by single points on the curves. Further, they were all considered equal and the clustering itself was based on multivariate Gaussian distribu-

tions, where the covariance structure was allowed to vary as well as the number of mixture components [10], [11]. The number of clusters and the underlying covariance structure was selected based on the Bayesian Information Criterion (BIC).

Some material properties were expected to be more decisive at clustering than others. Identifying the most decisive properties could reduce the number of tests and would make it easier to place materials in the right cluster. To gain insight into the material property importance, as well as being able to classify new materials according to the identified clusters, a classification tree was trained to the un-weighted data [12]. If the classification tree was general for all bricks, and not only for the 44 with a complete set of material properties, other bricks with incomplete data set could be handled by imputing missing values by a principal component based method [13]. Five clusters of bricks were identified using this approach [7].

Cluster analysis based solely on un-weighted material properties as done in [8] and in this study, may lead to clusters that not necessarily perform hygrothermally alike, e.g. expressed by temperature, relative humidity or moisture content. Therefore, clustering based on output data from hygrothermal simulations were performed as well. If this analysis could identify the hygrothermally most decisive material properties, these could be weighed accordingly in an input clustering. In the end, a user will only have access to input, and should therefore be able to choose an appropriate input cluster based on a few available material properties.

3. IMPACT OF MATERIAL PROPERTIES ON HYGROTHERMAL BEHAVIOUR

3.1 TYPE OF ANALYSIS

Impact characterisation is often done by a sensitivity analysis, simulating the same situations with stochastic variations of one variable at a time, e.g. through Monte Carlo simulations. However, bricks are described by several properties, some of which are correlated. Random combinations of properties could therefore mean simulation with unrealistic bricks. Instead, a modified sensitivity analysis was done based on 44 types of bricks from the Delphin database, i.e. the only variation is the brick. The robustness of clustering based on output data from simulations, is evaluated by including two Danish locations (weather data) and two constructions; a solid masonry wall with plaster on the inside and the same wall with internal insulation, resulting in 176 simulations made with the software DELPHIN ver. 5.8.

3.2 BOUNDARY CONDITIONS

The walls included in the simulations are one and a half brick thick with no insulation and with 50 mm of a CaSi based insulation system, respectively. The walls were SW oriented using weather data from the EU-project Climate for Culture [14]. Two Danish locations were used. Internal climate corresponded to humidity class B [15]. Output from the simulation describing how materials in the wall behaved to the exposure were represented by temperature, relative humidity

and moisture content at two specific positions within the wall; close to the external and internal surface of the brick wall, respectively, as shown in Figure 1.

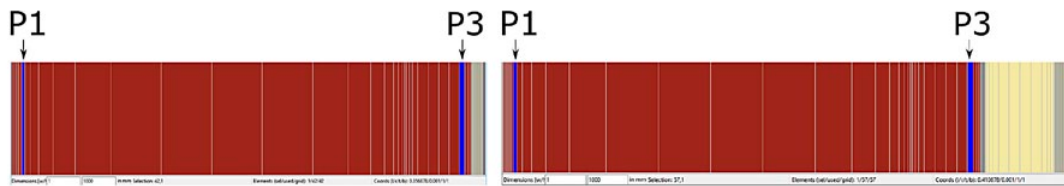

Figure 1. Delphin modes' construction detail. Not insulated wall (brick and plaster; left) and insulated wall (brick, glue mortar, CaSi insulation and plaster; right). Exterior to the left. Analysis of output data focused on results 9 mm from the exterior (P1) and 7.5 mm from the brick/plaster interface (P3).

Moisture content was chosen as the decisive parameter in the output clustering analysis as it showed the highest variability. Furthermore, moisture is more decisive than temperature in most failure modes, and by using moisture content, instead of relative humidity, the temperature dependency is avoided. Further details about input and output data are given in [7].

3.3 CLUSTERING BASED ON OUTPUT DATA

To create clusters, the bricks were ranked after 'Sum of moisture content' representing the area under the moisture content vs time curve for a given time period, or the median of the moisture content for this period. Figure 2 shows an example using these approaches.

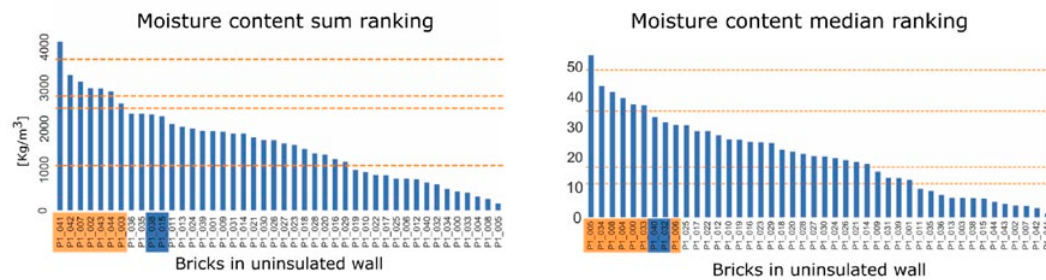

Figure 2. Ranking of bricks based on sum of moisture content (left) and moisture content median (right) at the exterior of a SW oriented 1½ brick thick wall without insulation. Location Copenhagen, winter 2026–2027 (Dec 1 to Mar 1). The seven highest-ranking brick types in the sum diagram (left), marked with orange, are in the median diagram (right) mixed with two other brick types marked with blue in both diagrams.

Focus was on winter conditions and bricks with high moisture content, as they are probably most important when it comes to failure modes. Six of the seven highest-ranking brick types in the left part of Figure 2 (sum of moisture content) were also highest-ranking in the right part (median); i.e. sum and median approaches resulted in similar clustering, which in general was the case in this study.

However, comparing results at different positions within the wall, showed that the clustering was dependent on whether it was based on output at the external or internal surface, cf. Figure 3. This indicates that the failure mode would be important, as high moisture content at the external surface (P1, Figure 1) is critical in relation to frost damage, and high moisture content in bricks close to the brick-plaster interface (P3) is critical when it comes to mould growth.

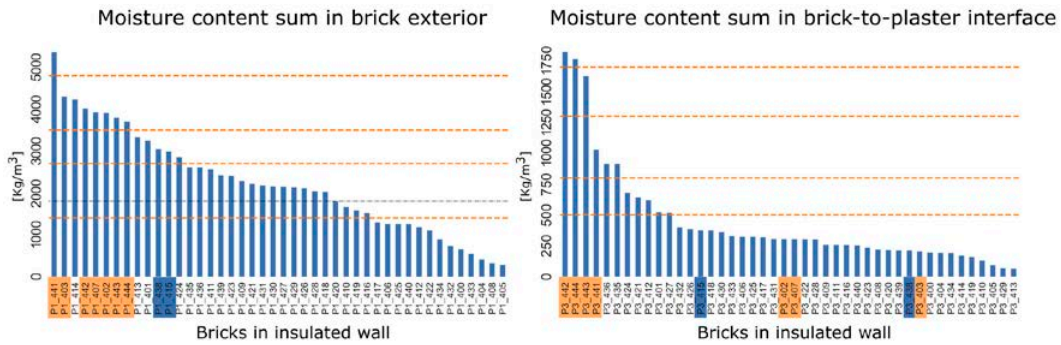

Figure 3. Ranking of bricks based on sum of moisture content at the exterior (left) and the brick-plaster surface (right) of an insulated 1½ brick thick SW oriented wall. Location Copenhagen, winter 2026–2027 (Dec 1 – Mar 1). Bricks marked with orange and blue boxes refer to the highest-ranking bricks in Figure 2.

3.4 IMPACT CHARACTERISATION

If bricks in a specific cluster, identified as described in section 3.3, have a considerable lower variation in certain properties than for bricks in general, these properties are likely to have a high impact. Figure 4 shows the result of this approach used at open porosity, thermal conductivity, specific heat capacity and effective saturation moisture content. A prerequisite for the approach is that a high moisture content in bricks is important when evaluating the robustness of internal insulation systems.

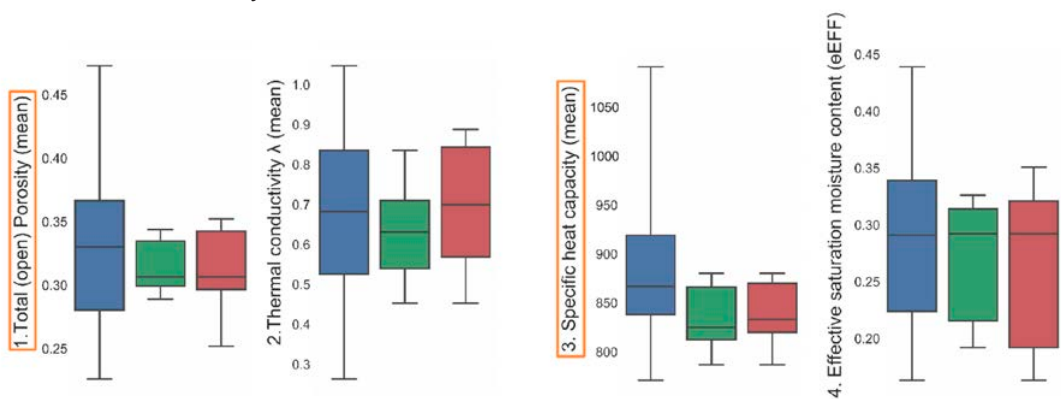

Figure 4. Variation of open porosity, thermal conductivity, specific heat capacity and effective saturation moisture content for 44 types of bricks in total (blue boxes), the upper cluster consisting of six types of bricks in a not insulated wall (green), and the upper cluster consisting of eight types of bricks in an insulated wall (red). Boxes mark 25 and 75 % quantiles. Upper clusters are identified as shown in Figure 2 and Figure 3.

Figure 4 indicates that open porosity and specific heat capacity do have more impact than thermal conductivity and effective saturation moisture content. In the two first cases, the variation for the upper clusters (green and red boxes) was considerably lower than for the bricks in total (blue boxes), while this was not the case for the two other parameters. Further, bulk density was identified as having a high impact [7].

4. DISCUSSION

4.1 MOISTURE PROPERTIES AND FAILURE MODES

The decisive material properties presented in section 3.4 are only true in the described situation and only when considering moisture content. If e.g. temperature is considered, thermal conductivity is probably of high importance as well. It is therefore likely that the importance of the material properties depend on what output is considered, which leads to the discussion of which failure mode should be considered. Opposed to the findings in section 3 concerning decisive material properties or not, the HAMSTAD project [16] found that HAM results depend strongly on the detailing and quality of material characterization. The discrepancies might be caused by different focus. While HAMSTAD is more focused on the accuracy of simulations, the aim of this paper is more practical; to facilitate the use of HAM simulations by making it easier for users to choose the right materials for simulations and help deciding what is the most important material properties to test.

Further simulations are suggested before discarding the idea of some material properties being hygrothermally more decisive than others, at least in some critical situations or failure modes. Likewise, simulations including other building materials than bricks could help defining within what range material properties seem to be less important than e.g. the weather. However, for the time being, in practice it may be of less importance which brick is chosen compared to other parameters, as long as the material parameter of the brick is within a certain range.

4.2 SETUP OF CLUSTERING

Moisture content [kg/m^3] was chosen as the best measure to compare bricks that perform hygrothermally alike, cf. section 3.2. The findings concerning clustering rely solely on a high moisture content in the winter and the output (moisture content) near the exterior surface. This leads to a ranking biased towards moist conditions and may thereby only be valid for the walls' behaviour under very humid conditions. However, a biased result is justifiable assuming that the relevant failure modes prevail under high levels of moisture content.

The ranking of the bricks varied in the different scenarios although the same outcome (moisture content) was considered. It was therefore by falsification shown, that the decisiveness of material properties is not unique. However, further simulations can be made by varying several parameters, using quasi Monte Carlo methods. In this way, trends toward which material properties are the most decisive for some failure modes, could appear.

4.3 IMPACT CLUSTERING

For the input clusters twelve material properties were used (section 2). The impact characterisation was based on bricks ranked according to simulation outputs followed by output clusters (section 3.4). Had output and input clustering matched, all material properties would have been equally important. Figure 5 illustrates that this was not achieved.

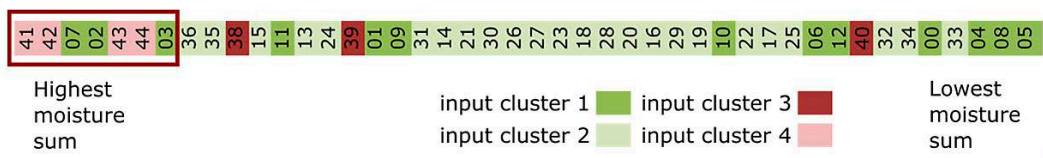

Ranking of bricks is according to sum of moisture content and therefore a representation of output clustering. Brick with highest and lowest sum of moisture content at left and right, respectively, referring to the ranking at Figure 2, left. Box represents upper output cluster, marked with orange at Figure 2, left. Colours represent input clusters. Ranking of bricks do not compile with input clustering.

A second location with a slightly different climate combined with a higher precipitation catch ratio and a lower drying potential, expressed by a lower absorption coefficient (short wave radiation) giving more extreme conditions, was included to test the robustness of the clustering presented in section 3.3. It showed another ranking of bricks with a high moisture content, indicating that changes in boundary conditions, e.g. microclimate, with the current methodology influence the clustering and possibly conclusions drawn from this.

In Delphin, bricks are not only described by the twelve material properties represented by single numbers; additional functions (calibrated material functions) are used to describe the materials. This could explain some of the differences between input and output clusters, especially because very moist conditions have been used in the examples. One of the findings in input clustering was that neither sorption nor suction curves were important [7], which may be because they are represented by one single point each. Adding more points as single material properties would probably not change this, as each point would be considered as a material property. Maybe the curves should be represented in another way. One possibility could be to present them as simple functions like in [17] and use the coefficients as parameters.

Clustering requires a threshold value or any other clustering criteria. The current study has not aimed to define such criteria; a simple threshold value has been used (sum of moisture content). This may provide inappropriate clusters as important details may escape, e.g. a failure mode that priorities long duration of relative high moisture content rather than short duration of even higher moisture content.

5. CONCLUSIONS AND FURTHER STUDIES

It has been investigated whether and how decisive material parameters for hygrothermal simulation outputs can be identified for historic building materials (bricks). It was found that:

- 1) Clustering of materials based on un-weighted material properties (input clusters; section 2) did not correspond to clusters based on moisture content close to the exterior of a masonry wall (output clusters; section 3), indicating that not all material properties were equally important.
- 2) Clustering based on moisture content at a specific depth in a masonry wall may not correspond to clustering based on moisture content in another depth; indicating the specific failure mode to be an important parameter. The cluster analysis did focus on extreme situations, e.g. situations in which failure modes may occur.
- 3) Other parameters in hygrothermal simulations may be more important than material properties, assumedly when the properties are within a tolerable range, e.g. weather or longwave radiation and precipitation catch ratio

At present it is not possible to tell the user of a simulation tool which material properties are the most important when choosing a material from the material database. Further clustering may reveal tendencies or even the possibility to determine the most decisive material properties if some of the more complex material functions e.g. can be represented by functions rather than single points on curves.

6. ACKNOWLEDGEMENTS

RIBuild has received funding from the European Union's Horizon 2020 research and innovation programme under grant agreement No 637268. Associate Professor Torben Tvedebrink and Research Assistant Simon B. Jørgensen, AAU have performed the clustering presented in this paper.

7. REFERENCES

- [1] European Commission. Energy-efficient Buildings PPP. Multi-annual Roadmap and Longer Term Strategy. Brussels, 2010.
- [2] E.J. de Place Hansen. "Improving the energy performance of historic buildings with architectural and cultural values" in *Interdisciplinary perspectives for future building envelopes*, Proc. 8th International Conference on Building Envelope Systems and Technologies. A. Tavit and O.C. Celik, Ed. Istanbul: Istanbul Technical University, 2017, pp. 648–658.
- [3] Robust Internal Thermal Insulation of Historic Buildings. Available: www.ribuild.eu [Feb. 1, 2018]
- [4] A. Blumberga, D. Blumberga, E. Kamendere, A. Kamenders, K. Kass, R. Purvins and G. Zogla. Report on historical building types and combinations of structural solutions. RIBuild Deliverable D1.1, 2015. Available: www.ribuild.eu [Feb. 1, 2018]
- [5] J. Grunewald. Diffusiver und konvektiver Stoff-und Energietransport in kapillarporösen Baustoffen. PhD Thesis, TU Dresden, Dresden, 1997.

- [6] H.M. Künzle. Simultaneous Heat and Moisture Transport in Building Components. One- and two-dimensional calculation using simple parameters. Fraunhofer IRB Verlag Stuttgart, 1995.
- [7] E.B. Møller. Report on material properties. RIBuild Deliverable D2.1, 2018. Available: www.ribuild.eu [Feb. 1, 2018].
- [8] J. Zhao, R. Plagge, N.M.M. Ramos, M.L. Simões and J. Grunewald. "Application of clustering technique for definition of generic objects in a material database." *Journal of Building Physics*, vol. 39, no. 2 pp. 124–46, 2015.
- [9] J. Zhao, R. Plagge, N.M.M. Ramos, M.L. Simões and J. Grunewald. "Concept for development of stochastic databases for building performance simulation. A material database pilot project." *Building and Environment*, vol. 84, pp. 189–203, 2015.
- [10] C. Fraley and A.E. Raftery. "Model-based Clustering, Discriminant Analysis and Density Estimation." *Journal of the American Statistical Association*, vol. 97, pp. 611–631, 2002.
- [11] C. Fraley, A.E. Raftery, T.B. Murphy and L. Scrucca. *mclust Version 4 for R: Normal Mixture Modeling for Model-Based Clustering, Classification, and Density Estimation*, 2012.
- [12] L. Breiman, J.H. Friedman, R.A. Olshen and C.J. Stone. *Classification and Regression Trees*. Wadsworth. 1984.
- [13] J. Josse and F. Husson. "missMDA: A Package for Handling Missing Values in Multivariate Data Analysis". *Journal of Statistical Software*, vol. 70, no. 1, pp. 1–31, 2016. doi:10.18637/jss.v070.i01
- [14] D. Jacob and L. Kotova. High-resolution datasets for the different IPCC scenarios for selected Case Study areas as input data for hygrothermal building simulation and complete high resolution dataset over entire Europe. Hamburg, 2013. Available: https://www.climateforculture.eu/index.php?inhalt=download&file=pages/user/downloads/project_results/D_01.2_final_publish.pdf [Feb. 1, 2018].
- [15] EN 15026:2007. Hygrothermal performance of building components and building elements – Assessment of moisture transfer by numerical simulation. Brussels: European Committee for Standardization, 2007.
- [16] HAMSTAD. Determination of liquid water transfer properties of porous building materials and development of numerical assessment methods. Available: https://cordis.europa.eu/project/rcn/53129_en.html [Feb. 1, 2018].
- [17] K.K. Hansen. Sorption isotherms. A catalogue. Technical report 162/86. Lyngby: Technical University of Denmark, Dept. of Civil Engineering, Building Materials Laboratory, 1986.

Can probabilistic risk assessment support decision-making for the internal insulation of traditional solid brick walls?

V. Marincioni and H. Altamirano-Medina

Institute for Environmental Design and Engineering, University College London (UCL), London, United Kingdom

Abstract – The majority of the traditional dwelling stock in the UK is made of solid brick walls. The energy efficient retrofit of such traditional buildings is one of the key measures to fulfil the Government pledge to reduce the GHG emissions by 80 percent by 2020. Internal wall insulation is one of the possible measures to preserve the heritage value of the external surface of the building fabric while improving the energy efficiency of a wall. However, it can lead to moisture-related risks, such as interstitial condensation and mould growth. This paper presents an overview of the reasons behind the need for an appropriate assessment of the moisture risk in internally insulated solid walls, and the state-of-the-art methods for risk assessment. Considering the uncertainty and variability of input data in the assessment of traditional solid walls, this paper argues that a probabilistic risk assessment can provide valuable information to support decision-making.

Keywords – internal wall insulation; solid masonry; probabilistic; moisture; risk assessment

1. INTRODUCTION

1.1 BACKGROUND AND CONTEXT

Internal wall insulation is important for the energy efficiency of the traditional building stock. However, it can lead to moisture accumulation, which can be detrimental to the health of occupants and the structural integrity of a building.

In the UK, it is commonly assumed that the majority of traditional and historic buildings were built prior to 1919 and their walls are usually made of solid masonry. In England and Scotland, these buildings account for around 20 percent of the housing stock. Energy efficiency interventions on solid walls are less cost-effective than other measures commonly installed in the UK; for this reason, properties with solid walls are categorised as “hard-to-treat” [1]. As of December 2016, only 8 percent of the solid walls in the UK have been insulated [2]; this figure reflects the challenges of solid wall insulation but also highlights the potential of this intervention in contributing to the reduction of greenhouse gas emissions pledged by the UK Government.

Building Regulations that apply across England and Wales recognise the fact that there are issues related to solid wall insulation for existing buildings. While they provide stringent guidance on the minimum thermal transmittance ($0.30 \text{ Wm}^{-2}\text{K}^{-1}$) of solid wall buildings after a thermal upgrade using insulation,

they also acknowledge that solid wall insulation may not be suitable for some buildings, hence higher thermal transmittances are accepted. For this reason, the Building Regulations state that all the interventions must be technically, functionally and economically feasible, therefore they advise limiting the loss of space to no more than 5 percent of internal floor area and assuring a payback time of 15 years or less. Moreover, they recommend the assessment of moisture related problems (e.g. condensation) in accordance with the requirements of Approved Documents (e.g. C and F) consequently acknowledging the need of assessing and minimising moisture risk as a result of solid wall insulation.

Currently, there is an increasing interest around moisture issues in UK buildings [3], and the approach to moisture assessment is changing. Various research projects concerning moisture in buildings have recently been funded by the UK Government and the construction industry, and carried out under the umbrella of the recently established UK Centre for Moisture in Buildings (UKCMB). The main documents on moisture control in buildings are currently under revision [4, 5] and other relevant documents have been published. A White Paper was published by the British Standard Institution [6] and it is advocating for a holistic approach to moisture risk assessment and guidance in buildings in the UK, which considers the interactions of the building fabric with other building elements, context and use, and accounts for the uncertainty of moisture sources, criteria and data. A report on the unintended consequences of solid wall insulation [7] identified the causes of potential problems with solid wall insulation and provided advice on how to tackle these issues. These documents acknowledge the complexity of moisture interactions that occur within the building fabric, especially in the case of insulated solid walls. Also, they warn on the adverse consequences that could be introduced if solid wall insulation is badly implemented.

The adverse consequences related to moisture accumulation in solid walls are many; these are even more relevant in case of historic buildings, where maintaining the heritage value of a building has priority [8]. For instance, moisture accumulation on timber (e.g. lintels, joist ends and structural elements) usually found embedded in traditional solid walls can lead to timber decay due to wood rot. Moreover, in some cases, moisture accumulation in internal wall insulation can undermine the expected energy savings [9] or lead to mould growth and condensation [3, 10], which may affect the health of occupants.

2. UNCERTAINTY AND VARIABILITY IN TRADITIONAL BUILDINGS

2.1 THE BUILDING FABRIC

To understand the moisture balance of traditional buildings, it is important to consider the variability existing in the building fabric, in the indoor environment and the weather.

The moisture balance of a building is mainly affected by core building materials; however, internal and external finishes (and other layers), which could have been added with the years (e.g. wallpaper, vinyl paint, gypsum plaster), might also affect the moisture balance of a wall [11]. The pre-existing moisture conditions of

a traditional building may vary considerably and can affect the moisture balance of the solid wall that is going to be insulated. Therefore, a thorough survey is advised [7], in order to have a good understanding of the pre-existing conditions of the solid wall [12] and to evaluate if previous alterations have harmed the integrity of the existing wall [13].

Hygic properties of building materials can show significant variability, given by the different geometry of the pore system [14], which for example affects the vapour diffusion resistance of the material. Roels et al. [15] found a wide range of vapour diffusion resistances in modern handmade bricks coming from the same batch. This shows that, although modern bricks are fired at controlled temperatures, the uncertainty of some material properties remains high.

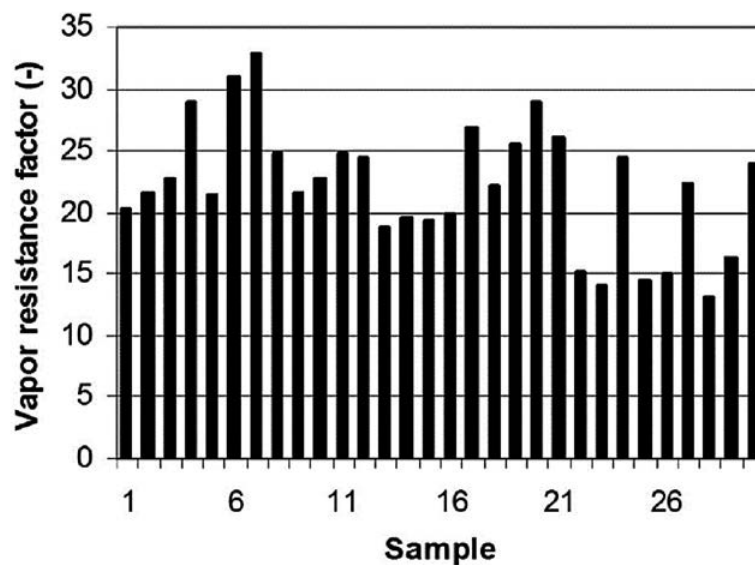

Figure 1. Water vapour resistance factor for 30 handmade bricks from the same batch (from Roels et al [15]).

In case of pre-1919 bricks, the firing process was uncontrolled, therefore the uncertainties related to material properties in traditional buildings can be even more significant. It is known that bricks that were stacked at the edge of the kiln were crumbly in texture and were used in the internal layers of walls, together with bricks made of poorer earth. On the other hand, bricks used for the façade were carefully moulded with higher quality ingredients [16]. Moreover, local clay was used for the production of bricks until the 19th century. Although the manufacturing process stayed the same, in the 19th century mass-production reduced the local differences that were common in previous times [17].

2.2 BUILDING OCCUPANTS AND INDOOR ENVIRONMENT

The moisture balance of a solid wall can also be affected by the levels of indoor vapour they are exposed to. In the UK, the indoor vapour generated in dwellings has been shown to vary significantly, representing humidity levels from very low

to medium [18]. This range of indoor vapour is likely to be defined by a number of building characteristics (e.g. size of the buildings), the occupants' density, the type of indoor activities (e.g. cooking, drying clothes) and the ventilation strategy (e.g. window opening schedule).

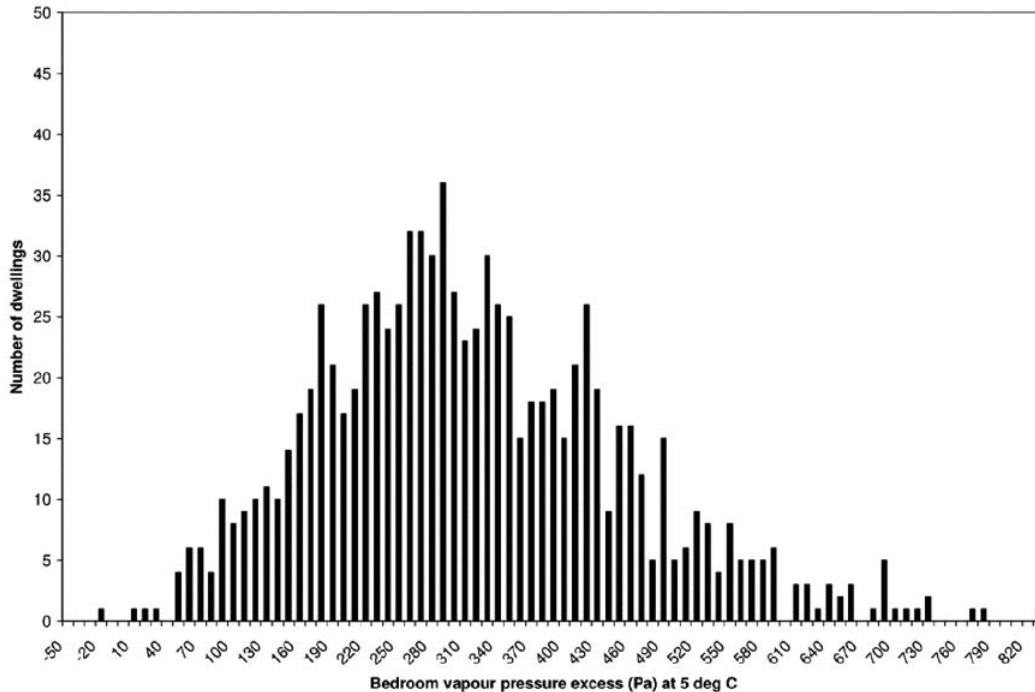

Figure 2. Frequency distribution of bedroom vapour pressure excess at 5 °C external temperature (from Ridley et al [18]).

2.3 THE WEATHER

Wind-driven rain and solar radiation are among the various climate parameters that can significantly affect a solid wall. They are particularly relevant for the moisture balance of traditional buildings, especially in case of un-rendered solid walls [19, 20].

Climate parameters have a temporal and spatial variability. It is important to consider the temporal variability of these parameters [21]; for this purpose, reference years for moisture design can be developed to consider representative external conditions [22, 23]. Moreover, due to climate change, the annual wettest day amounts are predicted to increase [24]. The spatial variability is important in complex urban environments; the urban geometry affects wind patterns, which in turn can lead to different wind-driven rain intensity across the same urban environment [25]. Also, the spatial distribution of wind-driven rain on an individual building can vary considerably [26].

3. RISK ASSESSMENT

3.1 MOISTURE RISK ASSESSMENT

A moisture risk assessment aims at evaluating the likelihood of building failures due to excessive moisture accumulation. In a risk assessment, the possible risks are identified (*risk identification*), the extent of the adverse consequences related to these risks is estimated (*risk analysis*), and the estimated levels of risk are compared with suitable risk acceptance criteria (*risk evaluation*).

At design stage, an appropriate moisture risk assessment can help with the choice of insulation system, and also helps identifying if internal wall insulation is possible at all. Moisture risk assessment can be used for comparing different constructions and evaluating the effects of interventions, taking into account the effects of the external climate and occupants' behaviour on the moisture balance of the building fabric [5].

3.2 DETERMINISTIC MOISTURE RISK ASSESSMENT

There are various methods available for the moisture risk assessment of internal wall insulation, with a focus on the wall-insulation interface. Hygrothermal simulations, as described in EN 15026 [21], can be used for moisture risk assessment when complex moisture interactions occur, as they consider several moisture transfer mechanisms and allow for the assessment of various moisture-related risks.

The majority of moisture risk assessment examples use a deterministic scenario analysis, where sets of scenarios (e.g. worst-case) are used to analyse potential adverse consequences. Most of the scenario analyses for internal wall insulation consider an average or a worst-case scenario and combine it with a parametric analysis (e.g. [9, 27]).

To be meaningful, these deterministic scenario analyses need representative input conditions (i.e. material properties, indoor environment, external climate). Average material properties are used, and the parametric analysis often focuses on changing the building materials used in the analysis. Regarding the indoor environment, the standard suggests that "internal conditions appropriate to the most severe likely use of the building shall be used" [21]; however, Künzle [28] argues that having severe indoor conditions in the risk assessment "may limit the choice of retrofit measures" for existing buildings. He suggests to use a low indoor relative humidity instead and to reduce the indoor vapour load by ventilation or dehumidification.

Regarding the outdoor environment, the climate file used is often a Test Reference Year; however, this climate file might not be representative for the moisture risk assessment of internal wall insulation subject to wind-driven rain [29], possibly because the construction of a TRY file does not consider rainfall as one of the climate indices.

The orientation with highest rainfall is considered in most cases, with the aim of representing worst-case scenario (e.g. [27, 30–32]). Also, a safety margin on

wind-driven rain is considered by some authors (e.g. [28], [32]) for the analysis of unwanted water penetration; this approach was developed for timber frame walls [33] but was extended to other structures [28]. However, introducing this safety margin does not necessarily lead to a worst-case scenario for the moisture risk assessment of internal wall insulation [29].

The benefits of the deterministic scenario analysis are its simplicity and low computational effort, which usually are desired characteristics for decision-making tools at design stage. However, it might not capture the risk completely, especially if inputs do not fully represent the variability and uncertainty found in (and around) traditional buildings.

3.3 PROBABILISTIC MOISTURE RISK ASSESSMENT

A probabilistic risk assessment can consider the inputs' uncertainties and variabilities identified for the material properties, the indoor and outdoor environments but requires a high computational time. Probably helped by the significant improvement of computational power, the interest in a probabilistic risk assessment for internal wall insulation has been increasing. The International Energy Agency's Annex 55 [34] focused on the development of a probabilistic approach to risk assessment; uncertainty was propagated through hygrothermal simulations. Zhao et al. [35] used a Monte Carlo Analysis for the stochastic analysis of internal wall insulation, and combined it with local sensitivity analysis. Vereecken et al. [36] analysed the hygrothermal risks and energy savings of various insulation systems using a probabilistic approach. This is now further developed within a EU-funded project [37].

The advantages of a probabilistic risk assessment are many. While a deterministic scenario analysis does not provide a full understanding of risk, a probabilistic risk assessment is able to represent the full range of possible outputs. In addition, it also describes the likelihood of risk and can provide information on the key factors affecting moisture risk.

An example of how probabilistic risk assessment can inform decision making is shown below. As it can be seen in the histogram of maximum relative humidity at the critical interface between capillary active internal wall insulation and an existing solid brick wall (Figure 3, left), the maximum relative humidity varies between 80 % and 100 % but the majority of instances fall around 95 %. To evaluate the moisture risk, a possible criterion for internal wall insulation, suggested by the WTA [38], is that the maximum relative humidity must not exceed 95 %. With a probabilistic risk assessment, it is possible to identify the percentage of results exceeding the threshold. Figure 3 (right) shows the empirical cumulative density function of maximum relative humidity; using the mentioned criterion, the graph shows that 33 % of results exceed the threshold. Consequently, the assessed insulation system could be considered an unacceptable solution for this case.

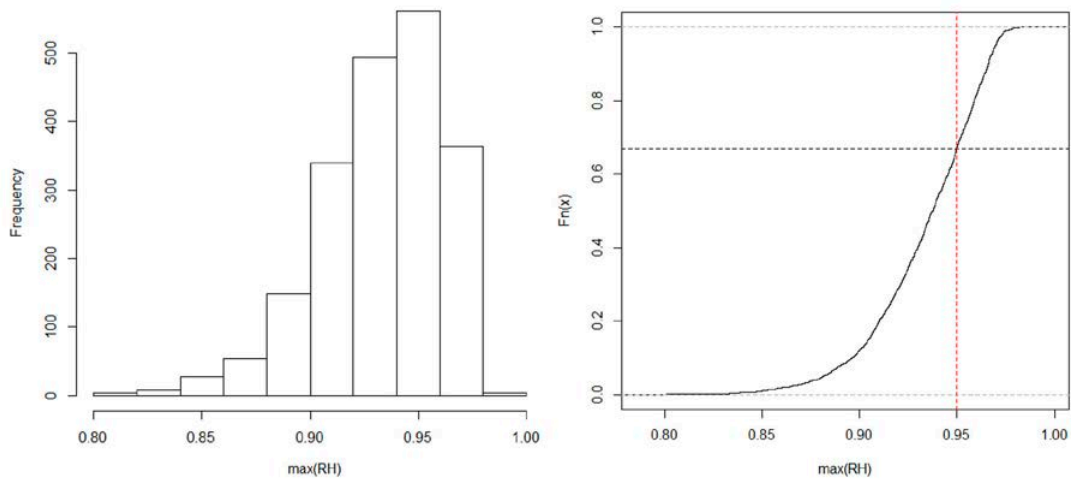

Figure 3. Histogram (left) and cumulative distribution function (right) of the failure criterion maximum relative humidity. Example for an internally insulated brick wall in Wales.

A probabilistic sensitivity analysis can provide additional information for moisture risk assessment, identifying the input factors that affect moisture risk the most. For example, in a sensitivity analysis of an internally insulated solid brick wall in Wales, shown in Figure 4, the most important factors were found to be related to the microclimate (i.e. orientation, rain exposure), some key material properties of the capillary active insulation (e.g. vapour diffusion resistance, effective saturation moisture content, thickness), and the regional climate. On the other hand, the indoor environment did not have a considerable influence on moisture risk.

The analysis was performed according to the elementary effects method (for more details see [39]), considering 34 input factors and the risks of condensation

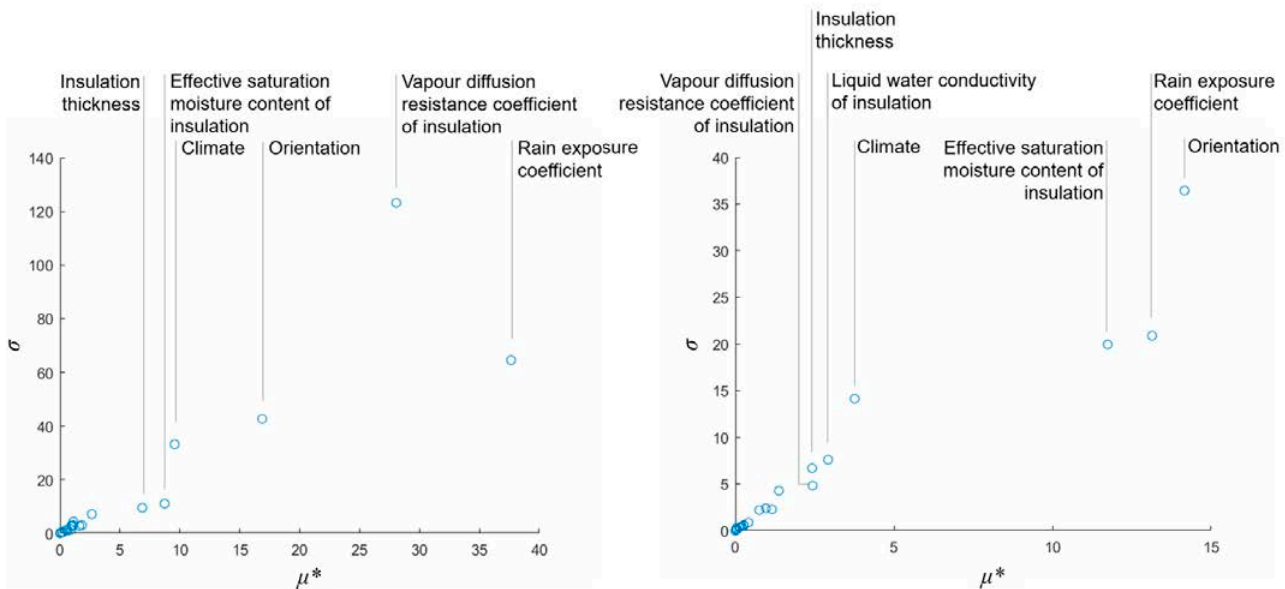

Figure 4. Probabilistic sensitivity analysis results, based on the elementary effect method: key factors for condensation (left) and mould growth (right). High values of μ^* describe factors with a relatively high influence on the response variable; high values of σ describe factors that are subject to interaction system. Example for a solid brick wall in Wales, internally insulated with a capillary active system.

and mould growth. Overall, the sensitivity analyses regarding condensation and mould growth showed a fairly consistent result, indicating similar key factors. The variability of the regional climate was considered using a collection of 22 years of weather data; the variability of the indoor environment was described in Figure 2.

4. CONCLUSION

This paper presents an overview of the state of the art of moisture risk assessment of the internal insulation of traditional solid walls in the UK. The existing regulatory framework in the UK acknowledges the technical and practical limitations of internal wall insulation; however, the current guidelines need updating and some of the main documents concerning moisture risk assessment in buildings are under revision. For an appropriate moisture risk assessment, the complexity of moisture interactions in traditional solid walls need to be considered. The uncertainties and variability of material properties, indoor and outdoor climate can affect significantly the moisture balance of a solid wall.

Currently, moisture risk in internally insulated walls is assessed with a deterministic scenario analysis, coupled with a parametric study, which depends on the ability to identify representative inputs. An alternative approach, the probabilistic risk assessment, is able to capture the full range of possible outputs and provides information on the likelihood of risk, proving that probabilistic risk assessment can support decision-making for the internal insulation of traditional solid brick walls. Also, a probabilistic sensitivity analysis can inform on the relative influence of factors on the moisture risk, considering actual distributions of input data.

The main disadvantage of a probabilistic moisture risk assessment is the high computational effort, which could be solved developing a meta-model. Finally, it is important to note that both approaches highly depend on the quality of input data.

5. REFERENCES

- [1] British Research Establishment, "Energy Analysis Focus Report A study of Hard to Treat Homes using the English House Condition Survey," 2008.
- [2] HM Department for Communities and Local Government, "English Housing Survey. Headline report.," 2017.
- [3] N. May, M. Ucci, and C. McGilligan, "Health and Moisture in Buildings – A Report from the UK Centre for Moisture in Buildings," 2017.
- [4] HM Government, *Approved Document C – Site preparation and resistance to contaminants and moisture*. 2013.
- [5] BSI, *BS 5250:2011 Code of practice for control of condensation in buildings*. 2011.
- [6] N. May and C. Sanders, "Moisture in buildings: an integrated approach to risk assessment and guidance," 2017.
- [7] C. King and C. Weeks, "Designing out unintended consequences when applying solid wall insulation," 2016.
- [8] N. May and C. Rye, "Responsible Retrofit of Traditional Buildings," 2012.
- [9] E. Vereecken and S. Roels, "Capillary active interior insulation: do the advantages really offset potential disadvantages?," *Mater. Struct.*, vol. 48, no. 9, pp. 3009–3021, Jul. 2014.

- [10] S. Urlaub and G. Grün, “Mould and dampness in European homes and their impact on health,” 2016.
- [11] D. Pickles, I. Brocklebank, and C. Wood, “Energy efficiency and historic buildings,” 2017.
- [12] M. Smith, “Avoidance and diagnosis of problems associated with internal wall insulation,” *J. Build. Surv. Apprais. Valuat.*, vol. 6, no. 1, pp. 1–15, 2017.
- [13] BSI, “BS 7913:2013 Guide to the conservation of historic buildings,” 2013.
- [14] H. S. L. C. Hens, “Modelling the heat, air and moisture response of building envelopes: what material properties are needed, how trustful are the predictions?,” *ASTM Int.*, vol. 4, no. 2, 2007.
- [15] S. Roels, J. Carmeliet, H. S. L. C. Hens, O. Adan, H. Brocken, R. Czerny, C. Hall, A. Hamilton, K. Kumaran, Z. Pavlik, L. Pel, R. Plagge, and F. Tariku, “Moisture Transfer Properties and Material Characterization,” 2002.
- [16] P. Borsay, *The English urban renaissance – Culture and society in the provincial town 1660–1770*. Oxford: Clarendon Press, 1989.
- [17] C. Turner and R. Partington, *Homes through the decades. The making of modern housing*. NHBC Foundation, 2015.
- [18] I. Ridley, M. Davies, S. Hong, and T. Oreszczyn, “Vapour pressure excess in living rooms and bedrooms of English dwellings: Analysis of the Warm Front dataset,” 2007.
- [19] V. Marincioni and H. Altamirano-Medina, “Effect of orientation on the hygrothermal behaviour of a capillary active internal wall insulation system,” in *10th Nordic Symposium on Building Physics*, 2014, pp. 1238–1243.
- [20] M. Abuku, H. Janssen, and S. Roels, “Impact of wind-driven rain on historic brick wall buildings in a moderately cold and humid climate: Numerical analyses of mould growth risk, indoor climate and energy consumption,” *Energy Build.*, vol. 41, no. 1, pp. 101–110, Jan. 2009.
- [21] BSI, *BS EN 15026:2007 Hygrothermal performance of building components and building elements – Assessment of moisture transfer by numerical simulation*, vol. 3. 2007.
- [22] X. Zhou, D. Derome, and J. Carmeliet, “Robust moisture reference year methodology for hygrothermal simulations,” *Build. Environ.*, vol. 110, pp. 23–35, 2016.
- [23] D. Zirkelbach, E. Tanaka, E. Marra, C. Schiessl, T. Schmidt, T. Hevesi-toth, and Y. Flucke, “Energieoptimiertes Bauen: Klima- und Oberflächenübergangsbedingungen für die hygrothermische Bauteilsimulation Kurztitel: Klimamodelle,” 2016.
- [24] P. Jones, C. Harpham, C. Kilsby, V. Glenis, and A. Burton, *Projections of future daily climate for the UK from the Weather Generator*. 2009.
- [25] D. Derome, A. Kubilay, T. Defraeye, B. Blocken, and J. Carmeliet, “Ten questions concerning modeling of wind-driven rain in the built environment,” *Build. Environ.*, vol. 114, pp. 495–506, 2017.
- [26] B. Blocken and J. Carmeliet, “Spatial and temporal distribution of driving rain on a low-rise building,” *Wind Struct.*, vol. 5, no. 5, pp. 441–462, 2002.
- [27] P. Häupl, J. Grunewald, and U. Ruisinger, “Hygrothermal analysis of external walls within the reconstruction of the Rijksmuseum Amsterdam,” in *Structural Studies, Repairs and Maintenance of Heritage Architecture IX*, 2005, vol. 83, pp. 345–354.

- [28] H. M. Künzle, "Accounting for unintended moisture sources in hygrothermal building analysis," in *Proceedings of the 10th Nordic Symposium of Building Physics*, 2014, pp. 947–953.
- [29] V. Marincioni and H. Altamirano-Medina, "Identifying a Suitable Climate File for the Moisture Risk Assessment of Internally Insulated Walls Exposed to Solar-Driven Vapour Diffusion," in *Building Simulation 2017*, 2017, pp. 2123–2128.
- [30] M. Harrestrup and S. Svendsen, "Internal insulation applied in heritage multi-storey buildings with wooden beams embedded in solid masonry brick façades," *Build. Environ.*, vol. 99, pp. 59–72, 2016.
- [31] M. Guizzardi, J. Carmeliet, and D. Derome, "Risk analysis of biodeterioration of wooden beams embedded in internally insulated masonry walls," *Constr. Build. Mater.*, vol. 99, pp. 159–168, 2015.
- [32] G. R. Finken, S. P. Bjarløv, and R. H. Peuhkuri, "Effect of façade impregnation on feasibility of capillary active thermal internal insulation for a historic dormitory—A hygrothermal simulation study," *Constr. Build. Mater.*, vol. 113, pp. 202–214, 2016.
- [33] A. Tenwolde, "ASHRAE Standard 160P __ Criteria for Moisture Control Design Analysis in Buildings," *ASHRAE Trans.*, pp. 167–172, 2008.
- [34] H. Janssen, S. Roels, L. Van Gelder, and P. Das, "Annex 55, Subtask 2 Probabilistic tools.," 2014.
- [35] J. Zhao, R. Plagge, and A. Nicolai, "Stochastic study of hygrothermal performance of a wall assembly – The influence of material properties and boundary coefficients," no. February 2014, pp. 37–41, 2011.
- [36] E. Vereecken, L. Van Gelder, H. Janssen, and S. Roels, "Interior insulation for wall retrofitting – A probabilistic analysis of energy savings and hygrothermal risks," *Energy Build.*, vol. 89, pp. 231–244, 2015.
- [37] A. Tijssens, H. Janssen, and S. Roels, "Retrofitting historical buildings: a probabilistic assessment of interior insulation measures and the hygrothermal risks," in *4th WTA International PhD Symposium*, 2017, pp. 149–156.
- [38] WTA, "WTA-Merkblatt E-6-5/D: Innendämmung nach WTA II – Nachweis von Innendämmsystemen mittels numerischer Berechnungsverfahren.," 2012.
- [39] V. Marincioni, G. Marra, and H. Altamirano-Medina, "Development of predictive models for the probabilistic moisture risk assessment of internal wall insulation," *Build. Environ.*, vol. 137, pp. 257–267, 2018.

The effect of climate change on the future performance of retrofitted historic buildings

A review

L. Hao^{1,2}, D. Herrera² and A. Troi²

¹ Dept. Architecture, Built environment, and Construction engineering, Politecnico di Milano, Milano, Italy.

² Institute for renewable energy, EURAC research, Bolzano, Italy. Email: Lingjun.hao@eurac.edu

Abstract – Historic buildings account for more than one quarter of Europe’s existing building stock and are going to be crucial in the achievement of future energy targets. In order to ensure their endurance, conservation compatible solutions are needed. Nevertheless, some alteration in the climate is already certain and therefore the impact of climate change on retrofitted historic buildings should be considered in terms of occupants’ comfort, heritage conservation, and energy performance. Inappropriate interventions might weaken the potential of original passive climate adaptive system, such as thermal mass and night cooling, leading to higher risks of overheating. Similarly, retrofit solutions will change the moisture dynamics of historic envelopes, which might lead to moisture damages when combined with more extreme precipitation events. This paper reviews recent literature that provides evidence of climate change’s impact on retrofitted buildings, reveals potential future risks, and thereby throws light on new factors influencing the retrofit decision-making process.

Keywords – historic buildings; energy retrofit; climate change; overheating; wind-driven-rain

1. INTRODUCTION

Climate change is driven by the concentration of greenhouse gases (GHG) in the atmosphere. According to the 2014 IPCC (Intergovernmental Panel on Climate Change) report [2], the increase of global surface temperature by the end of the 21st century is expected to exceed 1° (relative to 1986–2005). Together with this temperature increase, extreme climate events are expected to be more frequent. The length, frequency and intensity of heat waves ¹ might increase in large parts of Europe, Asia and Australia. The EEA (European Environment Agency) also confirmed this tendency. The warming risk is particularly strong at high-latitudes. Moreover, both reports predicted a change in the precipitation patterns. It is very likely that “*extreme precipitation events will become more intense and frequent in many regions*” [2]. The increase in precipitation may particularly occur in winter, and in high-latitude regions.

1 Heat waves are excessively hot periods that last for several days or longer, which will cause the overheating of human body. [1]

Dating from 2000, several European projects studied the impact of climate change on historic buildings. For instance, the European project NOAH'S ARK [3] defined the meteorological parameters that are critical to the built heritage and developed a vulnerability atlas and a guideline to prepare structure and materials for future risks. On this basis, the CLIMATE FOR CULTURE project [4] enhanced the risk prediction method with high-resolution climate models and whole building simulation for specific regions. NANOMATCH [5] aimed at producing nano-structured materials for historic materials under the climate change context and PARNASSUS [6] focused on the impact of future flood and wind driven rain on historic buildings due to climate change and the validation of adaptation measures. Meanwhile, researchers from the ADAPT NORTHERN HERITAGE project [7] are currently working on the identification and implementation of adaptation activities for northern European countries. These projects confirmed the relevance of investigating the impact of climate change on historic buildings. The studies looked into the consequences of higher temperatures, shifting precipitation patterns, higher flooding risks, and rising sea levels, which will influence heritage conservation, energy performance and retrofit decisions. However, all these studies considered historic buildings in their original state, that is, prior to energy improvement intervention.

To limit climate change and guarantee energy security, there is an increasing attention to the retrofit of historic buildings. The construction sector contributes with 18.4 percent of total global anthropogenic GHG emissions [8]. Historic buildings constitute a considerable share of building stocks in Europe since more than 14 percent of existing buildings were built before 1919, 12 percent were built between 1919 and 1945 [9], and more than 40 percent were built before 1960 [10]. Most of these historic buildings have not undergone any energy retrofit. As a result, the average energy consumption in historic buildings is considerably higher than in modern buildings [10]. It is estimated that the retrofit of European dwelling stock built before 1945 could save up to 180 Mt of CO₂ within 2050 [9] and improve the thermal comfort of occupants.

At the same time, retrofit interventions might change the historic building state largely, from the indoor climate to the envelope's moisture dynamics [11, 12]. Combined with climate change, inappropriate retrofit solutions might further endanger building conservation and weaken buildings' performance. This paper reviews recent literature that provides evidence of climate change's impact on retrofitted buildings, highlights potential future risks and reveals the research needed.

Historic buildings are defined in this paper according to the scope of EN 16883 [13]. That is, a historic building does not necessarily have to be formally "listed" or protected. Historic building therefore refers to any building that is worth preserving. At the same time, retrofit refers to the modification of the existing structure aiming at improving a building's conditions to an acceptable level while minimising energy consumption.

2. IMPLICATIONS ON INDOOR CLIMATE

2.1 HISTORIC INDOOR CLIMATE

Indoor climate is the result of a complex interaction of several factors, e.g. the building geometry and envelope, the HVAC system, occupants, and external climate. Despite of the complexity, the direct correlation between internal and external climate has been investigated and verified. For instance, Coley et al. [14] explored the relationship between internal temperatures and changing external temperature. The building simulation included the dynamic representations of occupancy densities, solar gains, air densities, air flow and heating systems. Despite of those complex heat flows, the relationship responds to a linear regression with different constants of proportionality (that is, of steepness) depending on the building types. This could be used to estimate the buildings' resilience to climate change. The linear relationship between internal and external temperature has the potential to predict future indoor climate. In the study of the relationship between indoor and outdoor humidity, indoor absolute humidity has a strong correlation with outdoor absolute humidity year round [15]. In the case of historic buildings, Krame et al. [16] established an indoor climate prediction model for historic buildings. This is a simplified model developed with lumped model structure and optimised by genetic algorithms. In this model, indoor temperature is an output of outdoor temperature and solar irradiation and then indoor relative humidity is calculated by outdoor pressure and modelled indoor temperature. According to this research, indoor climate of historic buildings is strongly related to outdoor climate.

Retrofit solutions also play an important role in the configuration of the indoor climate. Pretelli and Fabbri [17] introduced several concepts to describe indoor microclimate of historic buildings at different use phases,² which emphasised the changes of indoor climate due to the retrofit interventions. At the same time the change of indoor climate is usually one of the main goals of retrofit actions to fulfil the requirement of thermal comfort. But research on indoor climate of historic building focused more on conservation rather than thermal comfort to protect historic characteristics. For instance, norms and studies usually aim at preserving building fabric and artefacts, or assess indoor climate non-invasively. [18–20] With the increase in the adoption of retrofit solutions in residential historic buildings, occupants' thermal comfort should also be assessed carefully.

2.2 THERMAL MASS, NATURAL VENTILATION AND OVERHEATING RISK

A building's envelope is the interface between the indoor and outdoor climates. Two main interactive processes controlled by this interface that influence the indoor climate are thermal inertia and ventilation. Temperature in "free running" buildings is closely related to outside temperature because of their depen-

2 Original Indoor Microclimate (OIM), Subsequential Indoor Microclimate (SIM) and Actual Indoor Microclimate (AIM)

dence on passive strategies [21, 22]. Thermal mass³ is a typical passive climate regulation strategy in historic buildings. A large body of literature has verified the thermal inertia effect of thermal mass which is beneficiary to internal thermal comfort [24, 25]. Passive cooling effect combining thermal mass and natural ventilation, especially night ventilation, could remove waste heat to maintain a comfortable temperature during summer. Many investigations showed the principle and effect of night cooling to reduce surface and indoor temperature [26–29]. However, this cooling system depends on building thermal mass, outdoor temperature swing [29], solar radiation, and ultimately user behaviour, as it has to be properly managed. For example, Gagliano et al. [30] suggested a time lag of 12 to 14 hours for the east walls of a historic massive building (Catania, Italy). Values above that time lag cut down the night cooling length, and values below that weakened the thermal inertia effect.

Internal insulation is a common solution for the energy retrofit of historic buildings [31–33]. However, the addition of insulation internally may minimise the benefits of thermal mass and ventilation. Combined with an outdoor temperature increase, overheating risk might increase in retrofitted buildings [34]. Studies of climate change impact on overheating are abundant [35, 36], but research on overheating risks in retrofitted historic building is still very limited.

Some investigations have analysed the drawbacks caused by internal insulation. For example, Gagliano et al. [37] verified that thermal mass and ventilation in historic buildings could reduce cooling demand by 30 percent in moderate climate, but additional insulation might cause drawbacks. In the simulation by Cirami et al. [38], the operative temperatures of six retrofit solutions are higher than the un-retrofitted historic wall on the hottest day, but night cooling could counterbalance the negative effect. An office building with thermal mass could effectively limit the change of indoor temperature. Yet, with the external temperature increase, daily average temperatures tend to be unacceptable, showing that thermal mass alone cannot ensure a comfortable thermal condition any longer [21]. Similarly, in Lee et al.'s [22] dwelling case study, overheating will occur in four constructions (including masonry) caused by additional insulation under future climates. Without natural ventilation or solar protection, thermal mass cannot remedy the situation. However, the implementation of new solar protection features on historic façades is in most cases not feasible due to the need of preservation of original historic style and features. In summary, previous research has already identified the potential risk of overheating in future retrofitted historic building, however there is still a need for further research to quantify the effect of climate change and to identify alternative retrofit solutions that prevent overheating and achieve thermal comfort both in present and future scenarios.

3 “Thermal mass” refers to construction mass that could store heat. It is usually featured with high heat capacity such as poured concrete, bricks and tiles. [23] C.A.Balaras, “The role of thermal mass on the cooling load of buildings. An overview of computational methods,” *Energy and Buildings*, vol. 24(1), pp. 1–10, 1996.

3. IMPLICATIONS OF FUTURE CLIMATE ON CONSERVATION

3.1 THE ROLE OF WIND DRIVEN RAIN AND INTERNAL INSULATION

The hygroscopic characterization of historic building material should be surveyed before retrofit actions. D'Ayala et al. [39] monitored temperature and relative humidity of two historic fabric inside the wall, concluded that historic material has different moisture absorption, and desorption features. Some solid masonry walls have a relatively high surface water absorption, the moisture content inside is more depending on exterior climate factors such as wind driven rain, solar radiation and wind [40].

Changes in climate factors (e.g. temperature, relative humidity, wind, precipitation) would accelerate the erosion of detailing and construction, or undermine binder and coating [41, 42]. Among all climate factors, Wind Driven Rain (WDR) is particularly important. It can cause both surface erosion and weaken the construction. Several research studies have shown that WDR directly affects the moisture content of historic envelopes. Abuku et al. [43] compared the mould growth risk with and without WDR in a moderately cold and humid climate (Essen, Germany) on the internal side of a historic brick wall (with no insulation). The results showed a serious risk on mould growth in summer and winter when WDR loads are considered, while there is a little risk without WDR loads. In a laboratory study by Johansson et al. [44], a 250 mm wall was built to represent the real historic wall situation and it was exposed to normal rain loads from Gothenburg (Sweden) and Bergen (Norway). The study revealed that WDR is the dominant factor determining the moisture movement in the wall. Furthermore, D'Ayala and Aktas [39] not only verified the adverse impact of WDR, but also inferred that more frequent rain could be more dangerous for historic envelopes. Nik et al. [45] simulated future moisture loads in a wooden wall and found that higher amounts of moisture will accumulate in walls in the future.

Implementation of internal insulation usually changes the moisture dynamics in historic walls. In some cases, internal insulation brings extra vapour diffusion resistance, which will impede the inward drying of the wall. This is especially important in the case of vapour tight insulation systems. Additionally, the temperature gradient across the original wall is reduced with the addition of insulation. In some cases the drying capacity of a historic wall will be reduced with interior insulation, leaving higher moisture content inside historic walls [44]. For instance, Odgaard et al. [46] monitored the hygrothermal performance of a historic masonry wall (with and without diffusion open insulation) for more than two years and found that the relative humidity of the insulated wall was 20–30 percent higher than the untreated wall. In the simulation of Kehl et al. [47], moisture content of the wooden beam end is always increased when coupled with interior insulation with or without convection, so that the increase could be assumed as an block impact of internal insulation.

With moisture accumulation in historic envelopes, the duration of materials and thermal efficiency of the building may be endangered. To ameliorate the situation, some historic retrofit projects adopted capillary active systems that minimise

the moisture content to acceptable levels [48, 49]. However, the results of some investigations still show scepticism about capillary active systems. Vereecken et al. [50] compared hygric performance of different internal insulation systems in the laboratory: vapour open, non-capillary active systems, capillary active systems, and vapour tight systems. Their results pointed out that, in the steady-state winter conditions, moisture captured by capillary active systems is higher than traditional vapour tight systems. An X-ray projection analysis showed that the moisture was accumulated between the glue mortar and the insulation. Klůšeiko et al. [51] also confirmed the high humidity levels in capillary active systems (calcium silicate, aerated concrete and polyurethane board with capillary active channels) which present the mould growth risk.

3.2 MOISTURE RISKS

When the high moisture condition persists, moisture induced damage may happen, such as mould growth, wood decay and frost damage. Envelopes with low surface temperature are the most vulnerable regions for mould due to the increase in relative humidity. These low temperatures are especially found in places such as thermal bridges, corner regions, cold attics, etc. [52]. Wood is very sensitive to mould growth, and timber is generally used in historic residential buildings. For example, wooden beams were often chosen to carrying the loads of the intermediate floor to the masonry walls. Under certain conditions of relative humidity and temperature, the decay will start with mould growth and follow with the development of wood-rotting fungi. Moreover, with high moisture state in winter, frost damage is prone to occur.

Mould growth affects negatively the environmental quality of the internal climate and the durability of the envelope. In order to prevent mould growth, different mould risk management approaches have been developed in different retrofitted building components. Climate change will impose new challenges to mould prevention. In the last 20 years, mould growth has been observed more frequently than before in ventilated attics of Sweden [53]. In their research, temperature and relative humidity levels will increase in cold attics in future climate scenarios, and the risk of mould growth will increase with these changes. Moreover, it is found that the addition of insulation could decrease the condensation on roofs but cannot decrease the risk of mould growth. In the case of wood structures, the durability depends on the moisture and temperature conditions and the exposure time to it. The decay of the wooden beams is usually caused by damaged downpipes, leaking roofs and WDR [47]. With more events of extreme rain in future, there will be more overflow in draining facilities. Meanwhile, the high relative humidity in walls caused by retrofit and extreme rain may also increase the risk.

Frost damage is a mechanical weathering process caused by water freeze-thaw cycle. Due to the changes that retrofit interventions impose on the existing structure (e.g. lower temperature on the outer surface due to the application on internal insulation), frost damage is more likely to occur. Zhou et al. [54] proposed the number of actual ice growth and melt cycles as an indicator for freeze-thaw

cycles. After simulations of uninsulated and internally retrofitted masonry walls, an increase of freeze-thaw cycles was found in Switzerland after internal retrofitting. Biseniece et al. [55] studied the thermal behaviour of retrofitted historic buildings with two insulation materials, and revealed a possibility of frost damage. As mentioned above, the frequency and intensity of precipitation in winter may increase in many regions of Europe, which has the implication of enhancing the risk of frost damage.

4. CONCLUSION

Climate change might have a significant impact on retrofitted historic buildings in terms of energy consumption, thermal comfort and heritage conservation. Through the review, the combined impact of changes in climate and retrofit is summarised: increased temperature, changed rain pattern and retrofit solutions will change the indoor climate and moisture dynamic in historic buildings. According to the review, overheating will be an increasing concern in the future. The combined effect of internal insulation and increased outdoor temperature may increase overheating risks; at the same time, moisture risks will increase since there will be more extreme precipitation and the drying capacity could be reduced by retrofit interventions.

However, in reviewed literature, direct proofs of these risks are limited. There is a need to carry out research to understand the capability of thermal mass and natural ventilation in future scenarios, as well as the function loss caused by different retrofit solutions. On the other hand, the relationship between moisture state of historic building, rain pattern changes and retrofit solutions should be evaluated on a regional basis. More importantly, retrofit solutions should be defined based on aforementioned knowledge and a clear awareness of future risks to maximise the occupancy's thermal comfort and building conservation.

5. REFERENCES

- [1] D. Li, T. Sun, M. Liu, L. Yang, L. Wang, and Z. Gao, "Contrasting responses of urban and rural surface energy budgets to heat waves explain synergies between urban heat islands and heat waves," *Environmental Research Letters*, vol. 10, no. 5, p. 054009, 2015.
- [2] EEA, "Climate change, impacts and vulnerability in Europe 2016 An indicator-based report," European Environment Agency, Luxembourg 2017.
- [3] C. Sabbioni, P. Brimblecombe, and M. Cassar, *The atlas of climate change impact on European cultural heritage : scientific analysis and management strategies*. Anthem, 2010.
- [4] J. Leissner. (2018). *Climate for culture*.
- [5] (26/02). *Nano-systems for the conservation of immovable and moveable polymaterial Cultural Heritage in a changing environment*. Available: <http://www.nanomatch-project.eu/>
- [6] (26/02). *PARNASSUS Ensuring Integrity, Preserving Significance*. Available: <http://www.ucl.ac.uk/parnassus>
- [7] (2017, 26/02). *Adapt northern heritage*. Available: <http://adaptnorthernheritage.eu/>

- [8] *Climate Change 2014 Synthesis Report*, 2015.
- [9] A. Troi, "Historic buildings and city centres – the potential impact of conservation compatible energy refurbishment on climate protection and living conditions," presented at the International Conference Energy Management in Cultural Heritage, 2011.
- [10] BPIE, "Europe's buildings under the microscope, A Country-by-country Review of the Energy Performance of Buildings," Buildings Performance Institute Europe (BPIE) 2011.
- [11] D. Herrera and A. Bennadji, "A risk based methodology to assess the energy efficiency improvements in traditionally constructed buildings," in *International Archives of the Photogrammetry, Remote Sensing and Spatial Information Sciences – ISPRS Archives*, 2013, vol. 40, pp. 337–342.
- [12] S. P. Bjarløv, G. R. Finken, and T. Odgaard, "Retrofit with interior insulation on solid masonry walls in cool temperate climates – An evaluation of the influence of interior insulation materials on moisture condition in the building envelope," in *Energy Procedia*, 2015, vol. 78, pp. 1461–1466.
- [13] *EN 16883 Conservation of cultural heritage – Guidelines for improving the energy performance of historic buildings*, 2017.
- [14] D. Coley and T. Kershaw, "Changes in internal temperatures within the built environment as a response to a changing climate," *Building & Environment*, vol. 45, no. 1, pp. 89–93, 2010.
- [15] J. L. Nguyen, J. Schwartz, and D. W. Dockery, "The relationship between indoor and outdoor temperature, apparent temperature, relative humidity, and absolute humidity," *Indoor Air*, vol. 24, no. 1, pp. 103–112, Feb 2014.
- [16] R. Kramer, J. van Schijndel, and H. Schellen, "Inverse modeling of simplified hygrothermal building models to predict and characterize indoor climates," *Building and Environment*, vol. 68, pp. 87–99, 2013.
- [17] M. Pretelli and K. Fabbri, "New Concept of Historical Indoor Microclimate—Learning From the Past for a More Sustainable Future," *Procedia Engineering*, vol. 161, pp. 2173–2178, 2016.
- [18] Z. Huijbregts, R. P. Kramer, M. H. J. Martens, A. W. M. van Schijndel, and H. L. Schellen, "A proposed method to assess the damage risk of future climate change to museum objects in historic buildings," *Building and Environment*, vol. 55, pp. 43–56, 2012.
- [19] *EN 15759-1 Conservation of cultural property. Indoor climate. Guidelines for heating churches, chapels and other places of worship*, 2011.
- [20] *EN 15757 Conservation of cultural property. Specifications for temperature and relative humidity to limit climate-induced mechanical damage in organic hygroscopic materials*, 2010.
- [21] M. J. Holmes and J. N. Hacker, "Climate change, thermal comfort and energy: Meeting the design challenges of the 21st century," *Energy & Buildings*, vol. 39, no. 7, pp. 802–814, 2014.
- [22] W. V. Lee and K. Steemers, "Exposure duration in overheating assessments: a retrofit modelling study," vol. 45, no. 1–2, pp. 60–82, 2017.
- [23] C.A. Balaras, "The role of thermal mass on the cooling load of buildings. An overview of computational methods," *Energy and Buildings*, vol. 24(1), pp. 1–10, 1996.

- [24] S. Verbeke and A. Audenaert, "Thermal inertia in buildings: A review of impacts across climate and building use," *Renewable & Sustainable Energy Reviews*, 2017.
- [25] H. Johra and P. Heiselberg, "Influence of internal thermal mass on the indoor thermal dynamics and integration of phase change materials in furniture for building energy storage: A review," *Renewable & Sustainable Energy Reviews*, vol. 69, pp. 19–32, 2017.
- [26] J. Pfafferott, S. Herkel, and M. Jäschke, "Design of passive cooling by night ventilation: evaluation of a parametric model and building simulation with measurements," *Energy & Buildings*, vol. 35, no. 11, pp. 1129–1143, 2003.
- [27] Y. Chen, Z. Tong, and A. Malkawi, "Investigating natural ventilation potentials across the globe: Regional and climatic variations," *Building & Environment*, 2017.
- [28] P. Blondeau, M. Spérandio, and F. Allard, "Night ventilation for building cooling in summer," *Solar Energy*, vol. 61, no. 5, pp. 327–335, 1997.
- [29] E. Shaviv, A. Yezioro, and I. G. Capeluto, "Thermal mass and night ventilation as passive cooling design strategy," *Renewable Energy*, vol. 24, no. 3, pp. 445–452, 2001.
- [30] A. Gagliano, F. Patania, F. Nocera, and C. Signorello, "Assessment of the dynamic thermal performance of massive buildings," *Energy and Buildings*, vol. 72, pp. 361–370, 2014.
- [31] D. Milone, G. Peri, S. Pitruzzella, and G. Rizzo, "Are the Best Available Technologies the only viable for energy interventions in historical buildings?," *Energy & Buildings*, vol. 95, pp. 39–46, 2015.
- [32] G. Ciulla, A. Galatioto, and R. Ricciu, "Energy and economic analysis and feasibility of retrofit actions in Italian residential historical buildings," *Energy & Buildings*, vol. 128, pp. 649–659, 2016.
- [33] V. Kočí, J. Maděra, and R. Černý, "Computational assessment of energy efficiency and hygrothermal performance of retrofitted historical building envelopes," in *Energy and Sustainability*, 2015, pp. 185–196.
- [34] F. Stazi, A. Vegliò, C. D. Perna, and P. Munafò, "Experimental comparison between 3 different traditional wall constructions and dynamic simulations to identify optimal thermal insulation strategies," *Energy & Buildings*, vol. 60, no. 11, pp. 429–441, 2013.
- [35] S. Patidar, D. P. Jenkins, G. J. Gibson, and P. F. G. Banfill, "Statistical techniques to emulate dynamic building simulations for overheating analyses in future probabilistic climates," *Journal of Building Performance Simulation*, Article vol. 4, no. 3, pp. 271–284, 2011.
- [36] D. P. Jenkins, S. Patidar, P. F. G. Banfill, and G. J. Gibson, "Probabilistic climate projections with dynamic building simulation: Predicting overheating in dwellings," *Energy and Buildings*, vol. 43, no. 7, pp. 1723–1731, 2011/07/01/ 2011.
- [37] A. Gagliano, F. Nocera, F. Patania, A. Moschella, M. Detommaso, and G. Evola, "Synergic effects of thermal mass and natural ventilation on the thermal behaviour of traditional massive buildings," *International Journal of Sustainable Energy*, vol. 35, no. 5, pp. 411–428, 2014.

- [38] S. Cirami, G. Evola, A. Gagliano, and G. Margani, "Thermal and Economic Analysis of Renovation Strategies for a Historic Building in Mediterranean Area," *Buildings*, vol. 7, no. 3, p. 60, 2017.
- [39] D. D'Ayala and Y.D. Aktas, "Moisture dynamics in the masonry fabric of historic buildings subjected to wind-driven rain and flooding," *Building and Environment*, vol. 104, pp. 208–220, 2016.
- [40] M. Valentina and A. Hector, "Effect of orientation on the hygrothermal behaviour of a capillary active internal wall insulation system," presented at the Nordic Symposium of Building Physics 2014.
- [41] S.P. Gupta, "Climate change and its impact on monumental and historical buildings with reference to monuments of chhattisgarh," *Virology*, vol. 319(1), pp. 12–26, 2013.
- [42] R. Curtis and J. Hunnisett Snow, "Short guide—Climate change adaptation for traditional buildings," 2016.
- [43] M. Abuku, H. Janssen, and S. Roels, "Impact of wind-driven rain on historic brick wall buildings in a moderately cold and humid climate: Numerical analyses of mould growth risk, indoor climate and energy consumption," *Energy and Buildings*, vol. 41, no. 1, pp. 101–110, 2009.
- [44] P. Johansson *et al.*, "Interior insulation retrofit of a historical brick wall using vacuum insulation panels: Hygrothermal numerical simulations and laboratory investigations," *Building & Environment*, vol. 79, no. 8, pp. 31–45, 2014.
- [45] V.M. Nik, S. O. Mundt-Petersen, A.S. Kalagasidis, and P. De Wilde, "Future moisture loads for building facades in Sweden: Climate change and wind-driven rain," *Building and Environment*, vol. 93, pp. 362–375, 2015.
- [46] T. Odgaard, S.P. Bjarløv, and C. Rode, "Interior insulation – Experimental investigation of hygrothermal conditions and damage evaluation of solid masonry façades in a listed building," *Building and Environment*, vol. 129, pp. 1–14, 2018.
- [47] D. Kehl, U. Ruisinger, R. Plagge, and J. Grunewald, "Wooden Beam Ends in Masonry with Interior Insulation – A Literature Review and Simulation on Causes and Assessment of Decay," in *2nd Central European Symposium on Building Physics*, Vienna 2013.
- [48] J. Toman, A. Vimmrová, and R. Černý, "Long-term on-site assessment of hygrothermal performance of interior thermal insulation system without water vapour barrier," *Energy and Buildings*, vol. 41, no. 1, pp. 51–55, 2009.
- [49] J.G.G. Scheffler, "Material development and optimisation supported by numerical simulation for a capillary-active inside insulation material," in *Second international conference on building physics*, Leuven, Belgium, 2003.
- [50] E. Vereecken and S. Roels, "A comparison of the hygric performance of interior insulation systems: A hot box–cold box experiment," *Energy and Buildings*, vol. 80, pp. 37–44, 2014.
- [51] P. Klöšeiko, E. Arumägi, and T. Kalamees, "Hygrothermal performance of internally insulated brick wall in cold climate: field measurement and model calibration," *Central European Symposium on Building Physics*, 2013.
- [52] H. Ge and F. Baba, "Dynamic effect of thermal bridges on the energy performance of a low-rise residential building," *Energy and Buildings*, vol. 105, pp. 106–118, 2015.

- [53] V.M. Nik, A. Sasic Kalagasidis, and E. Kjellström, "Assessment of hygrothermal performance and mould growth risk in ventilated attics in respect to possible climate changes in Sweden," *Building and Environment*, vol. 55, pp. 96–109, 2012.
- [54] X. Zhou, D. Derome, and J. Carmeliet, "Hygrothermal modeling and evaluation of freeze-thaw damage risk of masonry walls retrofitted with internal insulation," *Building and Environment*, vol. 125, pp. 285–298, 2017.
- [55] E. Biseniece *et al.*, "Thermal performance of internally insulated historic brick building in cold climate: A long term case study," *Energy and Buildings*, vol. 152, pp. 577–586, 2017.

Hygrothermal properties of NHL mortars

P.F.G. Banfill

School of Energy, Geoscience, Infrastructure and Society, Heriot-Watt University, Edinburgh, UK

Abstract – Hygrothermal simulation software enables designers to assess the impact of insulation retrofits on solid walls before a retrofit project starts and help to avoid the negative effects on solid wall performance. However, the material databases used by the software lack information on the material properties of the traditional masonry used in Scotland. The hygrothermal properties of uncarbonated and carbonated lime mortar made with St Astier NHL2, NHL3.5 and NHL5 and Loanleven sand have been determined by laboratory testing. Thermal conductivity, sorptivity or water absorption coefficient by partial immersion, water vapour permeability (dry and wet cup), hygroscopic sorption, density and porosity results are presented.

Keywords – Natural hydraulic lime; mortar; hygrothermal properties.

1. INTRODUCTION

Water can cause building fabric deterioration and create unhealthy indoor environments. Its transport is closely linked to heat transfer and traditional solid masonry walls breathe. This moisture transfer ability determines their performance and durability. Installing more insulation to reduce energy consumption risks upsetting the equilibrium within a wall because energy efficiency retrofits almost always change the moisture performance of masonry. Hygrothermal simulation software enables designers to assess the impact of insulation retrofits on solid walls before a retrofit project starts and helps to avoid negative effects [1,2]. However, the material databases used by the software lack information on the material properties of traditional masonry. The aim of this work was to contribute to a dataset of material properties which can be used by designers to ensure that retrofits meet the needs of traditional buildings as well as achieve energy efficiency. This paper focuses on mortars made with contemporary natural hydraulic limes (NHLs) since these are common in northern Europe: it reports the hygrothermal properties of uncarbonated and carbonated NHL mortars. Air limes (CL90) and selected building stones will be reported at a later stage.

2. EXPERIMENTAL PROCEDURE

2.1 MATERIALS AND SPECIMEN PREPARATION

Three mortars comprising NHL2, NHL3.5 and NHL5 (St Astier, France) and oven-dry Loanleven concreting sand in the proportions shown in Table 1 (binder:sand 1:3 by volume) were prepared. These NHLs are the most commonly used in Scotland, which lacks indigenous lime manufacture, and the proportions are those recommended by Historic Environment Scotland [3]. Table 2 gives the particle size distribution of the sand. 12 litres of each mortar were mixed in a

Hobart 20 litre mixer for five minutes and tested using a standard (BS EN 459–2) flow table apparatus. The water was adjusted to achieve 150 mm flow (NHL2 and NHL3.5) and 160 mm flow (NHL5). Mortars were then cast into 100 mm cubes (steel moulds) and 360 x 240 x 12 mm thick tiles (timber moulds lined with cling film). Before the mortar had set the tiles were cut into 90 mm diameter discs using a simple cylindrical steel “cookie cutter” device and both cubes and tiles were allowed to harden in the moulds, covered in polythene sheet, for seven days. The specimens were demoulded and separated into two groups. Upon demoulding, the use of the cookie cutter had made it easy to separate the discs from the surrounding fragments. Half of the cubes, discs and fragments were stored at 20 °C in airtight drums to ensure they remained saturated. The other half were transferred to a TAS Series 3 controlled environment chamber and stored at 20 °C, 60 % relative humidity (RH) and 600 ppm CO₂ until 56 days of age. These curing and exposure conditions had been used previously to ensure full carbonation of the specimens [4]. The extent of carbonation was confirmed by spraying freshly fractured surfaces with 1 % phenolphthalein solution in alcohol as indicator. At the end of this process a set of uncarbonated and fully carbonated mortars with each NHL was available for further testing.

Table 1. Batch weights of mortar mixes

Binder type	NHL2	NHL3.5	NHL5
Mass of binder g	2090	2356	2700
Mass of sand g	15200	15200	15200
Mass of water g	2812	2640	2718
Flow mm	150	150	160

Table 2. Particle size distribution of Loanleven sand

Sieve size mm	0.063	0.125	0.250	0.5	1.0	2.0	4.0
% passing	4.0	18.5	42.5	66.5	80.5	95.5	100

2.2 THERMAL CONDUCTIVITY

Thermal conductivity was measured by the thermal probe method according to ASTM D5334-14, using the Thermtest TLS-100 instrument (Thermtest inc, Fredericton, Canada). It proved to be impracticable to drill a 3 mm test hole 100 mm deep in the centre of a specimen so a 3x3 mm groove was cut in the surface of a cube of each mortar, using a stone cutting disc mounted in a hand-held angle grinder. The cubes were conditioned by exposure to 60 % RH until constant mass and then the test probe was laid in the groove, surrounded in silicone thermal grease (RS Components, UK, thermal conductivity 5W/mK), and covered with a second cube of the same mortar. This ensured that the required test condition of a minimum of 50 mm depth of mortar around the probe was met. The test was replicated on three cubes.

2.3 SORPTIVITY AND WATER ABSORPTION COEFFICIENT

Water sorptivity and water absorption coefficient were determined gravimetrically by immersing one cast face and the trowelled face of cubes 2 mm deep in water and weighing at intervals over a 24 hour period or until water was visible on the top face, according to BS EN ISO 15148:2002. The test was replicated on three cubes.

2.4 WATER VAPOUR PERMEABILITY

The water vapour permeability was determined using both dry cup and wet cup methods according to BS EN ISO 12572:2001. The 90 mm diameter discs were cured or carbonated as described above and then conditioned by exposure to 60 % RH and sealed into aluminium cups. For the dry cup tests the cups contained desiccant (anhydrous CaCl_2) and for the wet cup tests they contained saturated KNO_3 solution (93 % RH). Having first trimmed any irregularities in the circumference, discs were placed (cast face down) onto a narrow bead of silicone sealant (B&Q plc) to create an air- and liquid-tight seal. The residual gap between the irregular circumference and the wall of the cup was sealed using molten paraffin wax (Akros Organics, Belgium). The assembled discs/cups were placed in the environment chamber at 20 °C and 60 %RH and weighed at the same time every week. At least three discs were tested for each combination of NHL class and carbonation state in both dry and wet cup tests.

2.5 HYGROSCOPIC SORPTION

The moisture absorption and desorption curves were determined according to BS EN ISO 12571:2013. Fragments of each mortar, weighing approximately 30 g, were oven dried to constant mass then placed successively in airtight boxes containing saturated salt solutions, giving 33 % (MgCl_2), 53 % ($\text{Mg}(\text{NO}_3)_2$), 75 % (NaCl), 85 % (KCl) and 93 % (KNO_3) RH. At each RH the fragments were weighed at intervals until constant mass (achieved in typically 2–3 days). The absorption curves were determined at successively increasing RH, after which the desorption curves were obtained at successively decreasing RH until a final oven dried mass gave a confirmation value. The test was replicated on three fragments of each combination of NHL class and carbonation state.

2.6 DENSITY

The density of hardened mortar was determined by displacement of water. The cubes saturated after completion of the sorptivity test were suspended beneath a balance and then weighed both in air and when immersed in water. The cubes were then oven dried to constant mass and the test repeated, taking care to complete the weighing quickly before significant absorption had occurred. The density of the water used in the calculation was that for the measured temperature [5].

2.7 POROSITY

Porosity and pore size distribution were determined by mercury intrusion porosimetry using a Quantachrome PoreMaster33 instrument, using a sample cell of

Ø8 mm × 20 mm and capillary volume of 0.5 ml, with 33000 psi final pressure, on fragments of each mortar of mass approximately 1 g.

3. RESULTS

3.1 THERMAL CONDUCTIVITY

Table 3 shows the thermal conductivity of the NHL mortars. Each entry is the mean of a single measurement on each of three cubes. The standard error, estimated from the variances about the mean values, is about 0.35. This suggests that only the differences between dryness and saturation are significant and that the trends of increasing thermal conductivity with binder hydraulicity and decreasing thermal conductivity upon carbonation are within experimental error.

Table 3. Thermal conductivity of NHL mortars, W/mK (means of 3 cubes)

Binder type		NHL2	NHL3.5	NHL5	NHL5
Uncarbonated	Dry	0.71	0.73	0.91	2700
	Saturated	1.16	1.30	1.79	15200
Carbonated	Dry	0.62	0.69	0.68	2718
	Saturated	1.03	1.22	1.29	160

3.2 SORPTIVITY AND WATER ABSORPTION COEFFICIENT

Figure 1 shows a typical set of sorptivity data, exemplifying the linear relationship with $\sqrt{\text{time}}$: the points at 24 hours, and often those at 6 hours, fall below the line because the water front has reached the free top surface of the specimen and no further mass gain can take place. Table 4 shows the sorptivity and water absorption coefficient. In all cases, the trowelled face has a lower sorptivity than the cast face, and the uncarbonated mortars have a lower sorptivity than the carbonated mortars. The sorptivity of uncarbonated mortars decreases with increasing hydraulicity of the binder, but that of the carbonated mortars decreases from NHL2 to a minimum value with NHL3.5 and reverts to a similar value of sorptivity with NHL5.

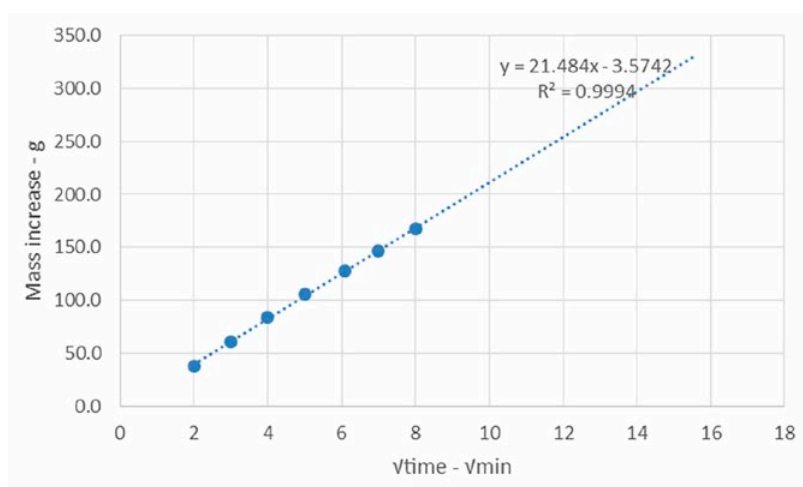

Figure 1. Typical sorptivity raw data for a carbonated NHL2 mortar cube.

Table 4. Sorptivity ($\text{mm}/\sqrt{\text{min}}$) and water absorption coefficient ($\text{kg}/\text{m}^2\sqrt{\text{sec}}$) of mortars (means of 3 cubes)

Binder type		NHL2		NHL3.5		NHL5	
		sorptivity	wac	sorptivity	wac	sorptivity	wac
Uncarbonated	Trowelled face	1.25	9.7	0.62	4.8	0.41	3.2
	Cast face	1.64	12.7	0.89	6.9	0.79	6.1
Carbonated	Trowelled face	1.59	12.3	0.95	7.4	1.70	13.2
	Cast face	2.04	15.8	1.55	12.0	2.51	19.4

3.3 WATER VAPOUR PERMEABILITY

Figure 2 shows graphs of mass gain or loss obtained from the dry cup and wet cup tests, respectively. The examples chosen have the lowest values of R^2 , the coefficient of determination, shown by any sample in the two test methods. The values of R^2 were somewhat lower (0.9931-0.9986) for the dry cup tests than for the wet cup tests (0.9984-1.0), suggesting that the dry cup tests are more sensitive to experimental conditions. Mass changes were recorded over eight weeks and the rate of change of mass taken as that calculated by linear regression using the six consecutive points that gave the highest value of R^2 . BS EN ISO 12572:2001 defines an acceptance criterion for the data, which requires five successive changes in mass (i.e. six consecutive points) to be within $\pm 5\%$ of the average change. This corresponds to a value of R^2 of 0.9998 and was achieved by 11 out of the 42 specimens tested.

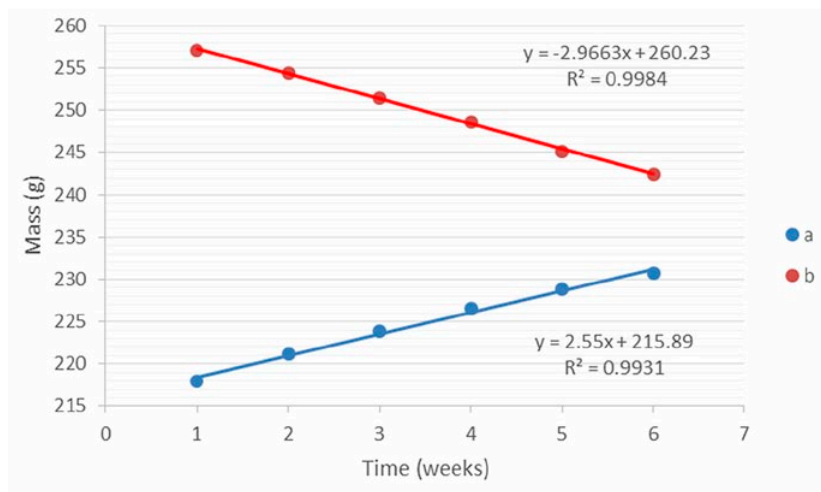

Figure 2. Examples of mass gain/loss curves for dry and wet cup tests: (a) dry cup, uncarbonated NHL5 mortar, (b) wet cup, carbonated NHL3.5.

Table 5. Water vapour permeability of NHL mortars, $10^{-12} \text{ kg}/(\text{m sec Pa})$ (means of 4 or 3* discs)

Binder type		NHL2	NHL3.5	NHL5
Uncarbonated	Dry cup	10.3	11.1	9.6*
	Wet cup	19.6*	22.4*	20.0*
Carbonated	Dry cup	11.9	11.2	7.1*
	Wet cup	23.6	25.7	16.3*

Table 5 shows the coefficient of water vapour permeability for all the mortars tested. The wet cup test gives a consistently higher value than the dry cup test. The difference between carbonated and uncarbonated NHL2 and NHL3.5 mortars is not significant but for NHL5 the carbonated mortar has a lower permeability than the uncarbonated one.

3.4 HYGROSCOPIC SORPTION

Figures 3 and 4 show curves of moisture content against relative humidity for uncarbonated and carbonated NHL mortars, respectively. Every curve exhibits hysteresis, with the desorption curve at higher moisture content than the absorption curve and there is a consistent dip in the desorption curve at 85 % relative humidity, which may be an experimental artefact caused by replenishing the solution in the chamber during the test. The moisture content of the uncarbonated mortars is consistently higher than that of the carbonated mortars at all relative humidities but there is no significant difference between the binder types.

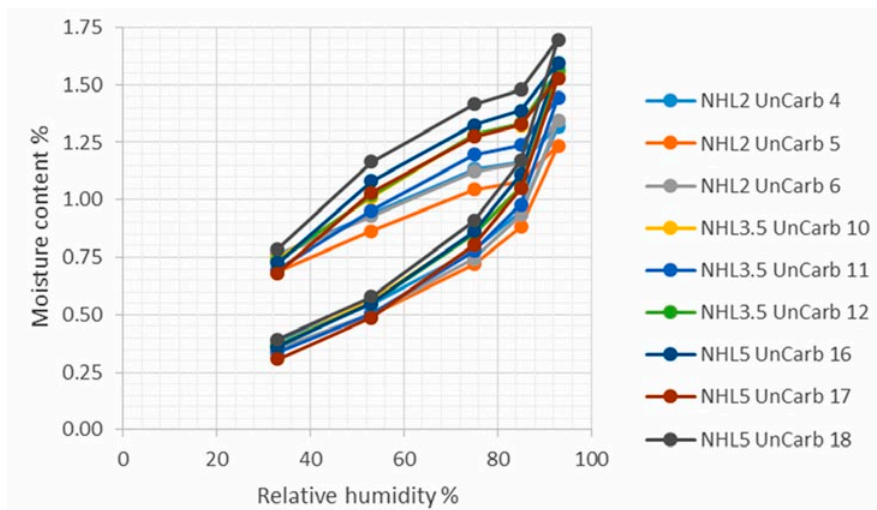

Figure 3. Variation of moisture content with relative humidity for uncarbonated mortars.

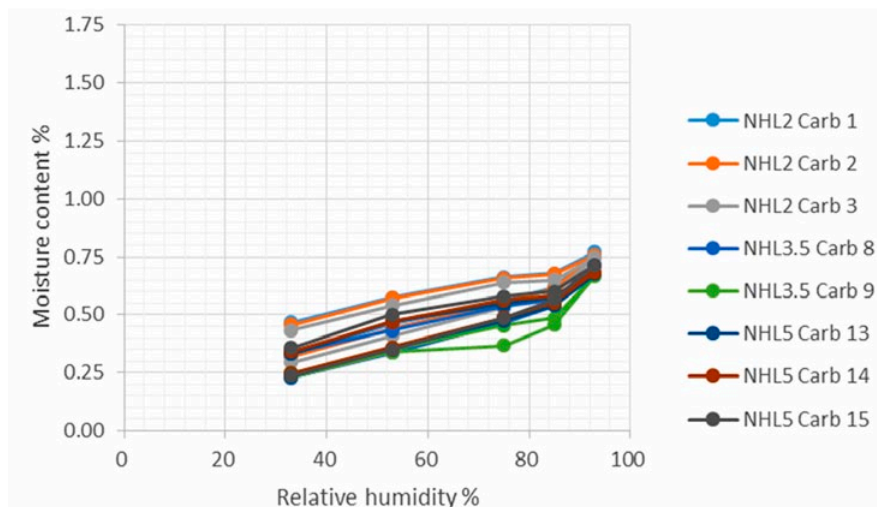

Figure 4. Variation of moisture content with relative humidity for carbonated mortars.

3.5 DENSITY

Table 6 shows the density of all the mortars in the saturated and oven-dry states, together with the corresponding saturated moisture contents (mc). The carbonated mortars are slightly denser than the uncarbonated mortars.

Table 6. Density of NHL mortars, kg/m³ (means of 3 cubes)

Binder type		NHL2	NHL3.5	NHL5
Uncarbonated	Oven dry	1911	1811	1949
	Saturated	2110	1989	2148
	% mc at saturation	10.4	9.8	10.2
Carbonated	Oven dry	1937	1806	1971
	Saturated	2121	1992	2166
	% mc at saturation	9.5	10.3	9.9

3.6 POROSITY

Figure 5 shows the pore size distributions of the uncarbonated and carbonated mortars. The uncarbonated mortars show a broadly bimodal distribution with two peaks at around 0.08-0.11 and 1.2–1.4 μm (NHL3.5 and NHL5) and at 0.4 and 3.6 μm (NHL2), whereas in the carbonated mortars the distribution is strongly unimodal with a peak at 1.3–1.6 μm (NHL3.5 and NHL5) and 0.7 μm (NHL2). Table 7 shows the total porosity of the mortars. The porosity of the carbonated mortars is consistently 2–3 % higher than that of the uncarbonated mortars.

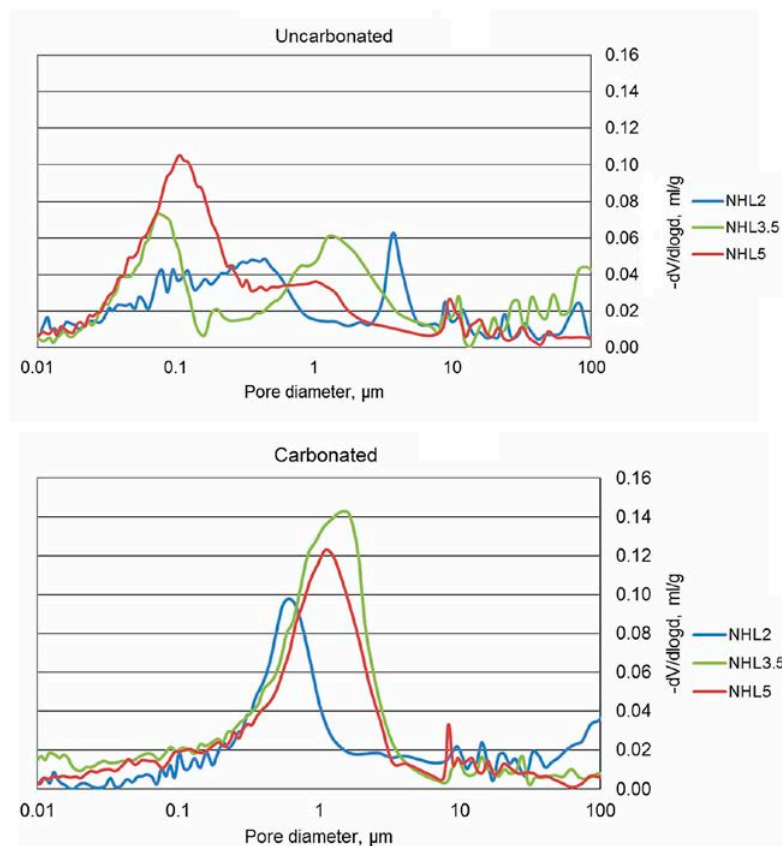

Figure 5. Pore size distributions of (upper) uncarbonated and (lower) carbonated mortars.

Table 7. Total porosity of NHL mortars, %

Binder type	NHL2	NHL3.5	NHL5
Uncarbonated	19.1	24.0	24.1
Carbonated	21.8	27.7	25.2

4. DISCUSSION

The results are consistent with the known effect of carbonation of NHL. Large tabular hexagonal crystals of $\text{Ca}(\text{OH})_2$ exhibiting a bimodal pore size distribution transform into small cubic crystals of the denser CaCO_3 which fill the pores [6]. The resulting pore size distribution has a single peak at around $1 \mu\text{m}$, as is clearly visible in scanning electron micrographs [6]. This accounts for the resulting increase in sorptivity and water absorption coefficient, which are both dominated by the larger capillaries. The slight increase in mortar density as a result of carbonation is explained by the uptake of CO_2 . The insignificant differences in thermal conductivity and water vapour permeability suggest that these are not affected by the pore size distribution. That the hygroscopic sorption is larger in uncarbonated than in carbonated mortars is probably due to the stronger affinity between $\text{Ca}(\text{OH})_2$ and water than between CaCO_3 and water.

In the context of assessing the thermal performance of historic masonry these results are important because, even though a wall is referred to as stone masonry, the mortar accounts for as much as 40 % of the material [7], so whilst the properties of building stones are widely available, there is a significant contribution made by the mortar. Additionally, the differences between uncarbonated and carbonated mortars may need to be taken into account because it is likely that the core of a wall may remain uncarbonated (and exhibiting a greater degree of hygroscopicity) for a very long time, whilst the surface zones may be carbonated in a few years, depending upon the climatic conditions they experience. This issue is likely to require care in the choice of values for simulation and justifies further experimental investigations on the materials used historically, including the air limes used in other regions.

5. CONCLUSIONS

Relevant hygroscopic properties of NHL mortars have been determined and can contribute to their successful utilisation in hygrothermal simulation of the effect of retrofitting insulation in historic buildings.

6. ACKNOWLEDGEMENTS

I am grateful to Gavin Spowart for general experimental assistance, and to Dr Laszlo Csetenyi, University of Dundee, who performed the mercury intrusion porosimetry.

7. REFERENCES

- [1] H.M. Künzle and A. Karagiozis. "Hygrothermal behaviour and simulation in buildings," in *Materials for energy efficiency and thermal comfort in buildings*. M.R. Hall, Ed. Cambridge, UK: Woodhead, 2010, pp. 54–76.

- [2] J. Little, C. Ferraro and B. Arregi. Assessing insulation retrofits with hygrothermal simulation. Historic Scotland Technical Paper 15. Edinburgh: Historic Scotland, 2015.
- [3] C. Torney, personal communication, May 2016.
- [4] P.F.G. Banfill, A.M. Forster and E.M. Szadurski. "Deterioration of natural hydraulic lime mortars, II: Effects of chemically accelerated leaching on physical and mechanical properties of carbonated materials." *Construction and Building Materials*, vol. 111, pp. 182–190, 2016.
- [5] G.W.C. Kaye and T.H. Laby. *Tables of physical and chemical constants*. London, UK: Longman, 1966.
- [6] A. El-Turki et al. "A microbalance study of the effects of hydraulicity and sand grain size on carbonation of lime and cement." *Construction and Building Materials*, vol. 23, pp. 1423–1428, 2009.
- [7] P.H. Baker. U-values and traditional buildings: in situ measurements and their comparisons to calculated values. Historic Scotland Technical Paper 10. Edinburgh: Historic Scotland, 2011.

Performance of insulation materials for historic buildings

Case studies comparing a super insulation material and hemp-lime

P. Johansson¹, A. Donarelli² and P. Strandberg³

¹ Dept. of Architecture and Civil Engineering, Chalmers University of Technology, Gothenburg, Sweden.
Email: par.johansson@chalmers.se

² Dept. of Art History, Uppsala University, Visby, Sweden. Email: anna.donarelli@konstvet.uu.se

³ Dept. of Building and Environmental Technology, Lund University, Lund, Sweden.
Email: paulien.strandberg@byggtek.lth.se

Abstract – There is a challenge to reduce the energy use of historic buildings while preserving their cultural values. New materials and solutions are being developed that could contribute to improving the energy performance of historic buildings without altering their character defining elements. The aim of this paper is to technically evaluate and compare a ‘high-tech’ material (VIP) with a ‘low-tech’ material (hemp-lime) for adding insulation to historical façades. This comparison was made with respect to thermal properties and moisture performance, as well as available environmental impact data. The VIPs are characterised by reaching a high level of insulation although they are thin, which means they do not alter the proportions of the building the way thick layers of insulation do. Hemp-lime on the other hand has the advantage of being in line with the traditional materials already present in historic buildings.

Keywords – historic building; energy efficiency; super insulation material; VIP; hemp-lime

1. INTRODUCTION

Historic buildings from before 1941 account for 25 percent of the energy use for heating in the Swedish building sector [1]. At the same time there are physical factors and legislation that regulate the measures that can be implemented in these buildings. The challenge is to reduce the energy use of historic buildings while preserving their cultural values. New, technically advanced materials and solutions – either ‘high-tech’ such as vacuum insulation panels or ‘low-tech’ such as hemp-lime – are being developed that could contribute to improving the energy performance without altering the character defining elements of historic buildings. These materials can be used in different cases and with different results on the overall building performance.

Conventional thermal insulation materials, such as mineral wool and expanded polystyrene (EPS), require a relatively thick layer of insulation to meet today’s energy requirements. For example, an insulation thickness of more than 22 cm is required using mineral wool ($\lambda=0.040 \text{ W}/(\text{m}\cdot\text{K})$) to reach a U-value of $0.18 \text{ W}/\text{m}^2\text{K}$, which is recommended by the Swedish building regulations for

renovated buildings [2]. Often, the physical space for adding insulation is limited in the building envelope where character defining elements should be kept, thereby limiting the achievable energy reduction.

Super insulation materials (SIMs) are ‘high tech’ materials and components with a substantially higher thermal resistance than conventional insulation materials. The thermal transmittance of the building envelope can therefore be substantially reduced with a limited insulation thickness, thus preserving the building’s proportions. One type of SIM is vacuum insulation panels (VIP) [3]. A material which is more compatible with traditional construction methods is hemp-lime. This is a ‘low-tech’ building material that consists of hemp shiv (the woody core part of the hemp stem) and building lime. It is different from conventional insulation materials as it has a relatively high thermal mass. The material properties of hemp-lime resemble those of historic materials, such as timber and lime.

The aim of this study is to technically evaluate and compare a ‘high-tech’ material (VIP) with a ‘low-tech’ material (hemp-lime) when additionally insulating historical façades. This comparison was made with respect to thermal properties and moisture performance, as well as available environmental impact data. Four Swedish case studies are presented in which the above-mentioned materials were tested to demonstrate how they could be used for improving the energy efficiency of historic buildings. Two case studies are located in Gothenburg, one is located in the historic town of Visby and the last one is a laboratory study at Lund University.

2. MATERIAL PROPERTIES

The materials used in this research were hemp-lime and VIP. Figure 1 shows hemp-lime after mixing and a VIP with the core material and air tight barrier visible.

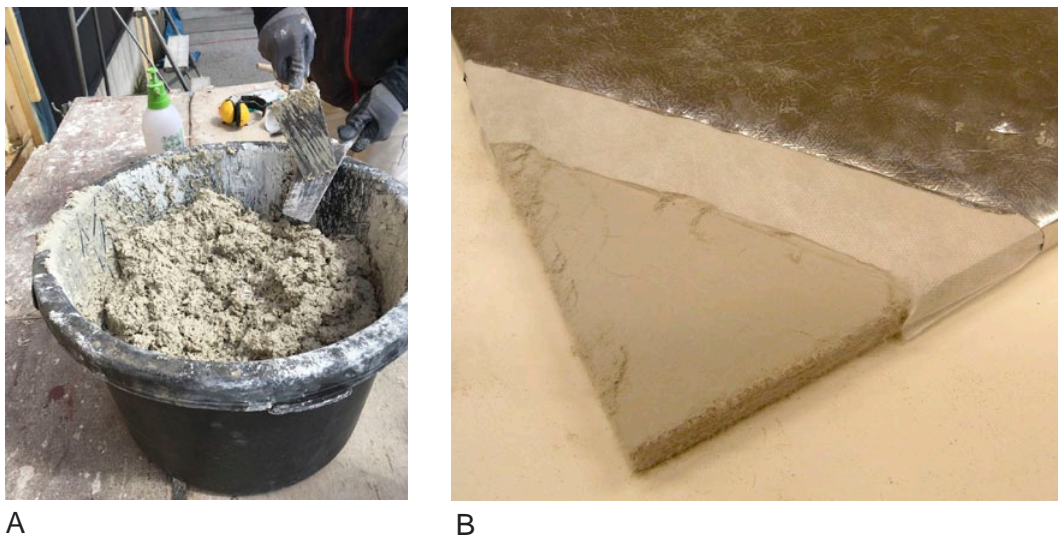

Figure 1. A) Hemp-lime mix, B) VIP with fumed silica core material and metalized film envelope. Photos: Paulien Strandberg, Pär Johansson.

VIPs were first tested in buildings in the early 1990s followed by several case studies both in laboratory and in the field [4]. They have different core materials (fumed silica, glass fibre, polyurethane, expanded polystyrene and others) and different envelopes (metalized film, aluminium laminate, stainless steel, glass, or combinations). VIPs are rigid panels which cannot be cut on site and are sensitive to puncturing. Therefore, attention must be paid to the design of details and envelope components. They are wrapped in an air- and moisture-tight metallized multi-layered polymer laminate which gives a vapour and liquid water transfer only at the edges between the VIPs.

Hemp-lime was first used in France in the 1990s. Hemp shiv was initially used to make concrete mixes lighter but it turned out to work very well in combination with building limes [5]. It has since been used both to cover masonry walls and to fill timber frame structures in new construction as well as in renovation. There are several projects in France and the United Kingdom where hemp-lime has been used in renovations of historic buildings [5, 6]. Hemp-lime has been considered suitable as an internal insulation material in historic buildings. Studies have shown that it had a higher thermal mass than most other insulation materials, which can reduce the effects of fluctuations in the outdoor climate on the indoor temperature [7]. The thermal conductivity of hemp-lime varies with the mixing ratio and with the application technique, where a denser material has higher thermal mass and higher thermal conductivity.

Among the important material properties for building materials are thermal conductivity, heat capacity and moisture diffusivity. The hygrothermal properties for hemp-lime and VIP differ substantially. The material properties of hemp-lime varies with the mixing ratio and application technique. The thermal conductivity is 0.06-0.19 W/(m•K) for hemp-lime [8–11] and 0.002-0.008 W/(m•K) for VIPs [3]. The specific heat capacity of hemp-lime is 300–470 J/(kg•K) [11], while it is 850 J/(kg•K) for VIPs [12]. For VIPs, a recent study has shown that the embodied emission are 28.5 kgCO₂eq/kg [13]. Hemp-lime is considered a carbon negative material [14, 15]. The cost for hemp-lime in Sweden is approximately 147–269 €/m³ [16], while the cost for VIPs is approximately 2 755 €/m³ [13].

3. CASE STUDIES

Four case studies are presented to demonstrate how VIPs and hemp-lime, respectively, can be used for improving the energy efficiency of historic buildings. VIPs are tested in two case studies; one as exterior insulation in a brick and wooden building (case 1) and one as interior insulation in a brick building (case 2). The case studies with hemp-lime are exterior insulation of a single family house in the historic Hanseatic town of Visby on the island of Gotland, Sweden, (case 3) and the last one exterior insulation of a wall in the laboratory of Lund University (case 4).

3.1 CASE STUDY 1: VIP ON EXTERIOR OF A MULTI-FAMILY BUILDING

Johansson, et al. [17] studied a multi-family building from 1930 in Gothenburg which was renovated in August 2010, see Figure 2. The building has a load-

bearing structure of brick on the ground floor (340 mm) and the walls in two upper floors have wooden planks (80 mm) covered with straw and plaster on the interior. On the exterior, a 22 mm thick vertical wooden cover boarding with rib flanges was mounted on top of a wind and waterproof tar paper. The building was non-insulated before the renovation. The original wall has a U-value of around $1.1 \text{ W/m}^2\text{K}$ both in the brick and wooden parts. Since the building is listed, the walls must not be changed too much to preserve the building's architectural characteristics. An additional insulation thickness of 80 mm was allowed. After renovation, the load-bearing construction was (from inside out) covered by a vapour barrier, 20 mm VIP, 30 mm mineral wool to protect the VIPs from damage, a 28 mm air space and a new wooden cover boarding with the same design as the original wall. This solution required that the windows were moved 80 mm to be in line with the new façade.

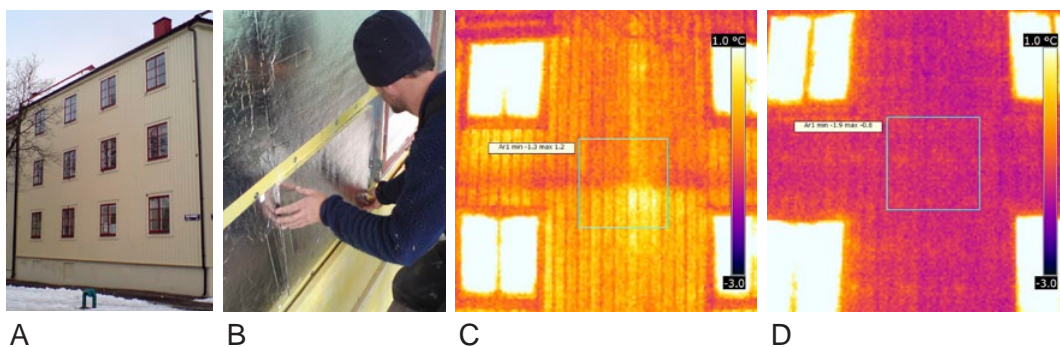

Figure 2. A) Multi-family building from 1930s, B) Installation of VIPs on the exterior, C) Thermography images from 7 February, 2018, non-insulated reference wall, D) VIP insulated wall, average temperature in the square at the intermediate floor between ground floor and first floor is $-1.4 \text{ }^{\circ}\text{C}$ and $-0.2 \text{ }^{\circ}\text{C}$, respectively. Photos: Pär Johansson.

Inside the wall and inside some of the apartments of the buildings, temperature and RH sensors were installed to evaluate the performance of the VIP and wall. The measurements were compared to a nearby non-insulated reference façade. The calculated energy use before retrofitting was $158.7 \text{ kWh/m}^2/\text{year}$ for heating and domestic hot water. Calculations show that the total energy use was reduced with more than 25 % for the case with a continuous VIP layer and without any thermal bridges. With regard to the thermal bridges in the façade, the final reduction of the total energy use became 20 %. As a comparison, changing the old windows ($U\text{-value } 3 \text{ W/m}^2\text{K}$) to windows with a $U\text{-value of } 1 \text{ W/m}^2\text{K}$ reduced the energy use by 15 %. The hygrothermal performance of the wall was improved after the renovation since the temperature in the load-bearing structure was increased. During seven years, the VIP layer was monitored by comparing the temperature drop over this layer. The evaluation showed that no visible degradation could be seen [18]. Infrared thermography was also used to evaluate the wall performance. Images from 7 February, 2018, showed that the exterior wall surface temperature was $1.2 \text{ }^{\circ}\text{C}$ higher on the non-insulated wall than on the wall with VIP, see Figure 2. The evaluation showed no visible degradation (i.e. elevated temperatures) of the VIPs.

3.2 CASE STUDY 2: VIP ON INTERIOR OF AN INDUSTRIAL BRICK BUILDING

An old industrial brick building, see Figure 3, south of Gothenburg is planned to be equipped with VIP on the interior of the wall during 2018. The walls are made of 500 mm thick non-insulated homogenous brick masonry which gives a calculated U-value of 1.0 W/m²K. The building was constructed in 1896 and has been reconstructed several times since then.



Figure 3. A) Industrial building from 1896 south of Gothenburg to be insulated on the interior with VIP, B) The test room inside the industrial building, C) Sensors in the external brick wall. Photos: Pär Johansson.

There are several challenges to renovate the building where the thermal performance of the walls is one example. The cultural values of the building have been evaluated and one of the features that is considered important is the brick façade. Therefore, interior insulation is considered to be a possible solution to reach sufficient energy performance [19]. Inside a part of the deserted building, a small room (2.1 x 2.6 x 4.0 m) has been constructed which consist of floor, walls and roof insulated with 170 mm mineral wool, and the exposed brick wall, see Figure 3. The room is heated to around 22 °C and ventilated by natural ventilation with 0.5 h⁻¹ air exchange rate. The air in the room is circulated by a fan to create homogenous temperature and moisture conditions in the entire room. The exterior wall is divided in three parts where VIP will be tested and compared to a non-insulated reference. The wall is equipped with hygrothermal sensors that every hour registers the temperature and relative humidity in the middle of the wall and at the interior surface. A weather station monitors the outdoor temperature, relative humidity, wind speed and rain intensity.

3.3 CASE STUDY 3: HEMP-LIME ON EXTERIOR OF A SINGLE FAMILY HOUSE

One gable section of a detached single family house in Visby's historic centre was renovated with hemp-lime render in September 2017, see Figure 4. The house was built in the mid-1800s and rebuilt to a large extent in the 1930's. It is built with a mix of construction techniques; the gable section of the eastern wall is built with wooden planks and the lower part of the same wall is built with lime stone. All façades are covered with lime rough-cast. The preservation of the

buildings in the historic town centre is safeguarded in building regulations which apply when making any renovations. According to the building regulations the original and existing lime renders in Visby should be preserved as far as possible [20]. Choosing materials and techniques that do not damage the underlying timber construction is crucial.



Figure 4. Detached historic single family house in Visby renovated with hemp-lime, A) Before renovation, B) During renovation, C) After renovation. Photos: Paulien Strandberg.

When the old render on the façade of the building was removed, the original wooden slats, placed diagonally on the timber for carrying the render, were exposed. These slats were kept for carrying the hemp-lime render. Since the space between the slats was only a few centimetres, some slats were removed to create some space between the slats for applying hemp-lime. A layer of hemp-lime of approximately 50 mm (the original thickness of the lime render) was put on the façade and finished with a 15 mm layer of traditional lime render on the outside. The hemp-lime was allowed to dry for a few weeks before a new lime render was applied. The mixing ratio of the hemp-lime was 1 part by volume air hardening lime for 2.5 parts by volume hemp shiv. Sensors to monitor temperature and relative humidity were placed in different locations and depths in the wall. Monitoring started in September 2017 and continues for one year. The results will give a better understanding of moisture levels and moisture flows in the walls. It will also give some indication regarding the temperature flows and insulating properties of the wall after renovation with hemp-lime.

3.4 CASE STUDY 4: HEMP-LIME ON EXTERIOR OF A LABORATORY WALL

At Lund University, two façades have been built at the laboratory of the Division of Energy and Building Design, see Figure 5. One façade resembles a traditional post-and-plank construction with a thick lime render about 80 mm. The other façade resembles a traditional post-and-plank construction that is renovated using hemp-lime (~100 mm) as additional external insulation. Behind each façade there is a room (3x3 m) that is insulated at all sides (floor, walls, ceiling). Therefore, the only heat loss that takes place will be through the façade. The energy use for heating the rooms behind the façades is monitored to evaluate the thermal performance of both façades. This way, a historic façade with a lime

render can be directly compared to a façade that is renovated with hemp-lime. The façades were constructed in April/May 2017, monitoring started in September 2017 and continues for one year. The façades are exposed to the outdoor climate. Moisture conditions (RH and moisture content) and temperature are being monitored at four depths inside the wall. The aim of the study is to compare the walls with regards to their energy performance. Therefore, the energy use (kWh/m², year) is measured and recorded continuously.



Figure 5. Construction of two full-scale test walls at Lund University, A) Construction of post-and-plank walls, B) Timber planks mounted between the posts, C) Application of hemp-lime on the post-and-plank wall. Photos: Paulien Strandberg.

The preliminary results from the laboratory show a lower energy use for heating in the room behind the hemp-lime façade. The room behind the hemp-lime façade uses 60–70 % of the energy use that is required by the room with the lime façade. The temperature variations are also less apparent in the insulated room.

4. CONCLUSIONS

This paper presents studies on two very different insulation materials – VIP and hemp-lime – to show their potential for application in historic buildings, where the preservation of the buildings' character defining elements is of importance. Characteristics and preconditions of historic buildings vary a lot. A solution to improve energy efficiency can work well in one historic building but not in another. Compatibility needs to be evaluated from both the technical and the historic preservation point of view and the purpose of the renovation needs to be defined clearly before undertaking a renovation project. Therefore, it is important to be able to use materials with different characteristics and properties, and to evaluate these properties both in laboratory and in field studies.

'High-tech' materials such as VIPs are new types of materials which may have to be tested under different conditions and with other methods compared to conventional insulation materials. Further, they have a limited flexibility as they cannot be adapted on the construction site. Hemp-lime, on the other hand, allows for greater flexibility as it can be used both as prefabricated boards and cast in-situ. With the use of hemp-lime the underlying construction of wooden slats or pegs can be maintained; it is even advantageous to do so. It also requires only limited

alteration of the original construction, which, in the Visby case study, is in line with the local building regulations.

VIPs are characterised by reaching a high level of insulation although they are thin, which means they do not alter the proportions of the building the way thick layers of insulation do. VIPs have higher thermal resistance than hemp-lime, while hemp-lime is more similar to historical materials than VIPs, and works well in combination with historical timber and limes.

5. ACKNOWLEDGEMENTS

This study is supported by the Swedish Energy Agency through the programme Spara och Bevara and the project 42856-1. We would also like to thank MölnDala Fastighets AB, Familjebostäder i Göteborg AB, Henrik Nilsson Byggnadsvård AB, Yttergrens Mureri, Gutekalk, Nordkalk, and the involved property owners in Visby, Sweden.

6. REFERENCES

- [1] Energimyndigheten, "Programbeskrivning för programmet Spara och bevara etapp 3, 2015-01-01 – 2018-12-31 (Programme Description for Save and Preserve Stage 3). [In Swedish]", 2014.
- [2] Boverket, "Regelsamling för byggande, BFS 2017:5 BBR 25 (Regulations for construction). [In Swedish]", Boverket, Karlskrona, Sweden, 2017.
- [3] U. Heinemann, "Annex 65 Long-Term Performance of Super-Insulating Materials in Building Components and Systems. Report of Subtask 1: State of the Art on Materials & Components–Case Studies (Report to be published)", 2018.
- [4] B. Adl-Zarrabi and P. Johansson, "Annex 65 Long-Term Performance of Super-Insulating Materials in Building Components and Systems. Report of Subtask 3: Practical Applications – Retrofitting at the Building Scale – Field scale (Report to be published)", 2018.
- [5] A. Evrard, A. De Herde, and J. Minet, Dynamical interactions between heat and mass flows in Lime-Hemp Concrete, 2006.
- [6] W. Stanwix and A. Sparrow, The hempcrete book: designing and building with hemp-lime. Totnes: Green Books, 2014.
- [7] R. Walker and S. Pavía, Thermal performance of a selection of insulation materials suitable for historic buildings, *Building and Environment*, vol. 94, pp. 155–165, 2015.
- [8] A. Shea, M. Lawrence, and P. Walker, Hygrothermal performance of an experimental hemp–lime building, *Construction and Building Materials*, vol. 36, pp. 270–275, 2012.
- [9] M. Barclay, N. Holcroft, and A. D. Shea, Methods to determine whole building hygrothermal performance of hemp–lime buildings, *Building and Environment*, vol. 80, pp. 204–212, 2014.
- [10] L. Arnaud, Comparative study of hygrothermal performances of building materials, in 11th international conference on non-conventional materials and technologies (NOCMAT 2009), Bath, United Kingdom, 2009.

- [11] P. de Bruijn and P. Johansson, Moisture fixation and thermal properties of lime–hemp concrete, *Construction and Building Materials*, vol. 47, pp. 1235–1242, 2013.
- [12] P. Johansson, Assessment of the Risk for Mold Growth in a Wall Retrofitted with Vacuum Insulation Panels, in 9th Nordic Symposium on Building Physics, Tampere, Finland, 2011, pp. 349–356.
- [13] H. Wallbaum and J. Kono, “Annex 65 Long-Term Performance of Super-Insulating Materials in Building Components and Systems. Report of Sub-task 4: Life Cycle Assessment, Embodied energy and Life Cycle Cost Assessment (Report to be published)”, 2018.
- [14] M.-P. Boutin, *et al.*, “Étude des caractéristiques environnementales du chanvre par l’analyse de son cycle de vie (Study of the environmental characteristics of hemp using a life cycle analysis). [In French]”, 2005.
- [15] K. Ip and A. Miller, Life cycle greenhouse gas emissions of hemp-lime wall constructions in the UK, *Resources, Conservation and Recycling*, vol. 69, pp. 1–9, 2012.
- [16] M. Grundvall, Hemp Built, Master’s thesis, Department of Architecture and Civil Engineering, Chalmers University of Technology, Gothenburg, Sweden, 2016.
- [17] P. Johansson, C.-E. Hagentoft, and A. S. Kalagasidis, Retrofitting of a listed brick and wood building using vacuum insulation panels on the exterior of the facade: *Measurements and simulations*, *Energy and Buildings*, vol. 73, pp. 92–104, 2014.
- [18] P. Johansson, B. Adl-Zarrabi, and A. Sasic Kalagasidis, Evaluation of 5 years’ performance of VIPs in a retrofitted building façade, *Energy and Buildings*, vol. 130, pp. 488–494, 2016.
- [19] P. Johansson, *et al.*, Interior insulation retrofit of a historical brick wall using vacuum insulation panels: Hygrothermal numerical simulations and laboratory investigations, *Building and Environment*, vol. 79, pp. 31–45, 2014.
- [20] Gotlands kommun, Byggnadsordning för Visby innerstad–tillhör detaljplan för Visby innerstad antagen 2010-02–22, laga kraft 2010-03–26. [In Swedish]. Visby: Gotlands kommun, 2010.

Cultural heritage compatible insulation plaster

Analysis and assessment by hygrothermal simulations

N.R.M. Sakiyama^{1,2}, J. Frick¹ and H. Garrecht¹

¹ Materialprüfungsanstalt Universität Stuttgart (MPA), Stuttgart, Germany.

Email: Nayara.Sakiyama@mpa.uni-stuttgart.de, Juergen.frick@mpa.uni-stuttgart.de

² Universidade Federal dos Vales do Jequitinhonha e Mucuri (UFVJM), Teófilo Otoni, Brazil.

Abstract – Improving thermal and energy performance of historic buildings has become a relevant research theme on the pursuit of European goals for climate change and energy savings. Most of the building-stock from before 1900 is composed of natural hydraulic lime-based mortars, which has a high vapour transmission rate and, therefore, was selected as binder for a cultural heritage compatible insulation plaster (ISOCAL) developed within the EU-Project EFFESUS (www.effesus.eu). After a large scale testing according to ETAG 004 was conducted, this work aimed to build a numerical model of the experiment to perform hygrothermal simulations with the Delphin software for ISOCAL. The material assessment considered two different supporting walls (brick and stone) in different scenarios. The analyses show decreasing mould growth on the surfaces of the walls that received the insulation, with greater water amount (%) inside the stone walls with ISOCAL at the inner face side, besides low condensation risk in all cases when applying ISOCAL outside.

Keywords – ISOCAL, insulation plaster, hygrothermal simulations, water content

1. INTRODUCTION

1.1 CULTURAL HERITAGE RETROFIT AND ASSESSMENT

Over the past years, energy efficiency in existing buildings has become a relevant research theme, including historic buildings that have architectural or cultural value and represent the unique character of European cities [1]. As a long-term aim, the European Union (EU) is committed to reduce 80–95 percent of greenhouse gas emissions by 2050, compared to 1990, and about 40 percent of these emissions are ascribed to the building sector [2]. Since most of the world's building stock for the next 20 years already exists [3], improving thermal and energy performance of all existing structures is an important measure for a sustainable future. To achieve these goals in cultural heritage refurbishments [5, 6], guidelines applications [4], methods and techniques have been used around the world.

In addition, researchers are using building simulation tools that when applied to historic buildings, can assess temperature and relative humidity of surfaces and wall layers, estimating their energy consumption and evaluating the benefits of retrofitting listed buildings [7]. In general, simulations analyses have been carried out to assess the retrofit performance of historic buildings with regards to material thermal transmittance [8]; photovoltaic systems and lighting aspects [9, 10];

mould growth and surface condensation both for retrofitting with external [11] and internal insulation [12], as well as energy efficiency assessment as a whole [13, 14].

Considering that historic buildings normally have listed properties that must be preserved, insulation from the inside is often the only option when optimizing the envelope performance of these buildings by improving its U-value. However, internal insulation not only reduces interior space, but also risks causing accumulation of moisture inside the wall material's pores, which can harm the structure and even human health in the long-term [15, 16]. Thus, the material behaviour concerning moisture regime is an important characteristic when improving the energy and thermal performance of cultural heritage buildings, and it is fundamental to accurately account moisture buffering in building simulations [17].

Weeb's work [18] discusses several energy retrofits performed in existing buildings and states that currently there is a push to better tailor analysis methods, particularly simulation tools, in order to reduce the discrepancy between simulated and real building performance. Specifically addressing the hygrothermal simulation programs, some difficulties are the calculation limitations presented in methods and available software, and the fact that most of them were developed in the research projects context being often not updated, thus preventing their use [19].

In this perspective, this article aims to evaluate the performance of a cultural heritage compatible insulation plaster, developed within the EU project EFFESUS (Energy Efficiency for EU Historic Districts' Sustainability) through hygrothermal simulations, which consider both heat and moisture transport process. The simulations were undertaken to evaluate the material behaviour when combined with two typical walls found in historic buildings during longer periods, and under natural climate conditions.

1.2 THE EFFESUS PROJECT

The main goal of EFFESUS project was to develop and demonstrate through case studies a methodology for assessing and selecting energy efficiency interventions, based on existing and new technologies that are compatible with the built cultural heritage [20]. EFFESUS developed and implemented new and adapted technologies/systems which are cost-effective, technically and visually suitable for application in historic buildings and urban districts [14].

One of these technologies, named ISOCAL, is a thermal insulating natural hydraulic lime mortar (NHL5) with EPS (expanded polystyrene) as insulation filling material [20]. The hygric and thermal properties of the material are presented in Table 1. The choice for natural hydraulic lime-based mortars is due to their low modulus of elasticity, which allows the normal expansion and contraction of the material in response to climate exposure, thus suppressing the use of dilation joints. In addition, the material has a high vapour transmission rate, which is beneficial to the breathing capacity of monolithic historic masonry, and is inversely proportional to mould growth and condensation potential in walls [21].

Table 1. Isocal thermal and hydric properties

Isocal	Properties						
	Thermal Conductivity	Density	Porosity	Water vapour resistance	Adsorption at 80 % RH	Specific heat capacity	Water uptake coefficient
	λ^1	ρ^1	Φ^2	μ^2	W_{80}	Cp^3	Aw^1
	W/mK	kg/m ³	m ³ /m ³	-	m ³ /m ³	J/kgK	kg/(m ² √s)
Isocal	0,0682	307	0,69	11,25	0,009	1000	0,007

¹ [21], ² [22], ³ [23]

A large-scale laboratory test (EOTA-wall test) was performed according to ETAG 004 [24] to assess the durability of the plaster system. The test chamber consisted of two opposing walls spaced one meter apart, with the plaster system facing each other. One wall was half lime stone and half brick masonry, and the other wall was composed of timber frames filled with brick masonry, each measuring 4.0 x 2.1 x 0.1 m (length x high x depth) [21]. This large-scale test consists of weathering cycles, where the wall is exposed to heat-rain and heat-cold cycles (Figure 1). Normally, this method is dedicated to test “External Thermal Insulation Composite Systems (ETICS) with Rendering” [24], not meant for insulation plasters or renders, but it provides a good accelerated test for durability due to their harsh conditions.

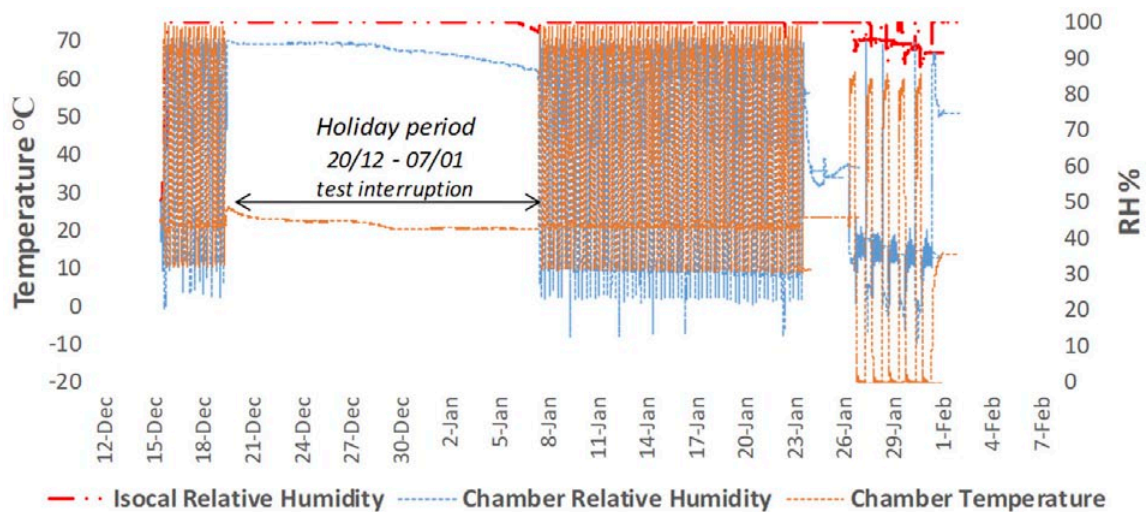

Figure 1. Weathering cycles and material moisture monitoring – EOTA wall test.

The relative humidity measured inside de plaster went up to 100 % within the first cycles during the heat-rain rounds (Figure 1). Therefore, the experiment results were not sufficient to evaluate the moisture storage function of the material. Hence, the hygrothermal simulation analysis is an alternative to overcome this gap.

2. HYGROTHERMAL SIMULATIONS

The ISOCAL behaviour related to moisture control was tested using the Delphin 5 software, a numerical simulation program that calculates coupled heat, humidity, and air transport in capillary porous building materials under natural climate conditions [25]. This software was chosen because it gives quantitative information related to hygrothermal performance of buildings, considering heat and moisture transport process by modelling physical events.

First, the large-scale experiment previously carried out was modelled in the software. The objective was not only to obtain more data about the ISOCAL hygrothermal behaviour, but also to validate the computational model, thus giving reliability to further results. The methodological procedure covers the material assessment in two different supporting walls that represent typical retrofitting cases in historic heritage: brick masonry (W1-W3) and lime stone (W4-W6). The wall composed of timber frames filled with brick masonry tested in ETAG 004 [24] [21] was not modelled. The analyses considered a base case without ISOCAL (W1 and W4), and different scenarios with an internal (W2, W5abc) or an external layer (W3, W6abc) of the developed natural hydraulic lime insulation plaster with different thicknesses (a=3, b=5, and c=8 cm), 14 cases in total. An inner or an outer coating lime plaster layer (0.82 W/mK) was also considered, always on the opposite side from the insulation. In addition, the walls were submitted to different

<p>Solid Brick (SB)</p> <p>W1 – without insulation W2abc- with interior insulation W3abc- with exterior insulation</p>	<p>W1</p>	<p>W2(abc)</p>	<p>W3(abc)</p>
	<p><i>U-Value W/(m²K)</i></p>	1,47	W2-3a - 0,90 W2-3b - 0,71
<p>Lime Stone (LS)</p> <p>W4 – without insulation W5abc- with interior insulation W6abc- with exterior insulation</p>	<p>W4</p>	<p>W5(abc)</p>	<p>W6(abc)</p>
	<p><i>U-Value W/(m²K)</i></p>	5,67	W5-6a - 1,69 W5-6b - 1,13

Figure 2. Simulated walls: in natural state and with insulation (with and without driven rain).

conditions: under and not under driven rain load. 28 one-dimensional (1D) cases were analysed (Figure 2), and all simulations were calculated for minimum heat protection according to DIN 4108–2 [26], and real climate conditions (Munich Test Reference Year – Delphin Library) for a six-year period.

As outputs, the simulations presented the temperature (°) and the liquid water content, LWC (volume fraction–%) inside the studied walls, in the presence or not of ISOCAL (W1-W6). The analysis was based on the criteria established by DIN 4108-3 [27], which addresses the protection against moisture subject to climate condition. Furthermore, the existing Mould Prediction with VVT Model available in Delphin was used to assess the mould growth on wall surface. While the lowest value of “0” means no mould growth, the maximal index of “6” means a complete coverage with mould.

3. RESULTS AND DISCUSSION

In this section, the results from the computational model of the EOTA-wall test are presented, and the hygrothermal responses of the six analysed walls (W1 – W6), with and without rain load, are discussed. Figure 3 shows that the outputs presented by the Delphin computational model are compatible with the data from the laboratory test. Consequently, it is corroborated that the ISOCAL properties used as input in the simulation software are reliable, thus validating the further computational models produced.

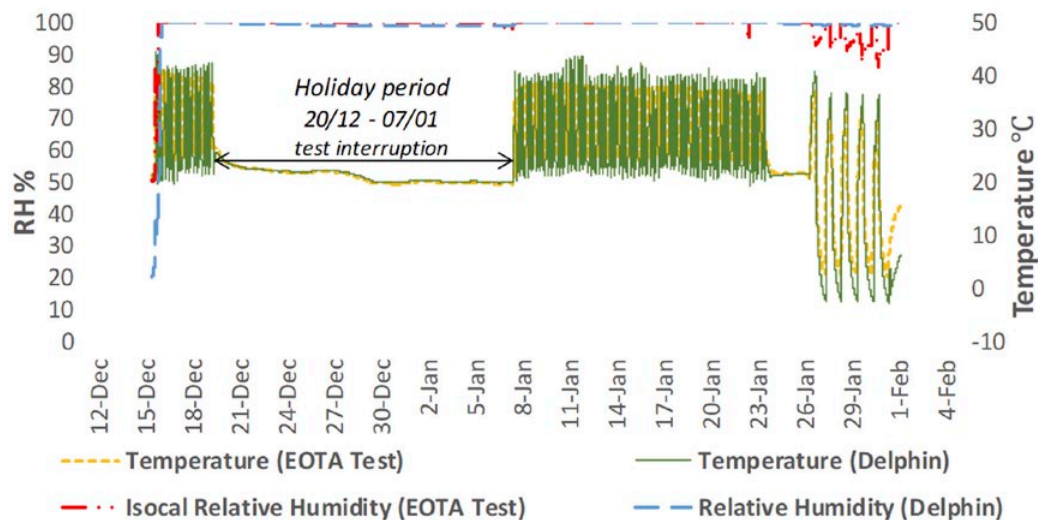

Figure 3. Comparison between Delphin results and EOTA wall test.

LWC and temperature profiles presented by the base cases (W1 and W4) and by the cases that received an internal ISOCAL layer (W2abc, W5abc), are shown in Figure 4. The results of the cases with an external layer of the developed insulation (W3abc, W6abc), are presented in Figure 5. In all graphs, it is possible to observe that there is an inversely proportional relationship between the temperature and the water content amount in the layers. At the same time, it is noted that the difference between LWC for the solid brick and for the stone wall, is also considerable.

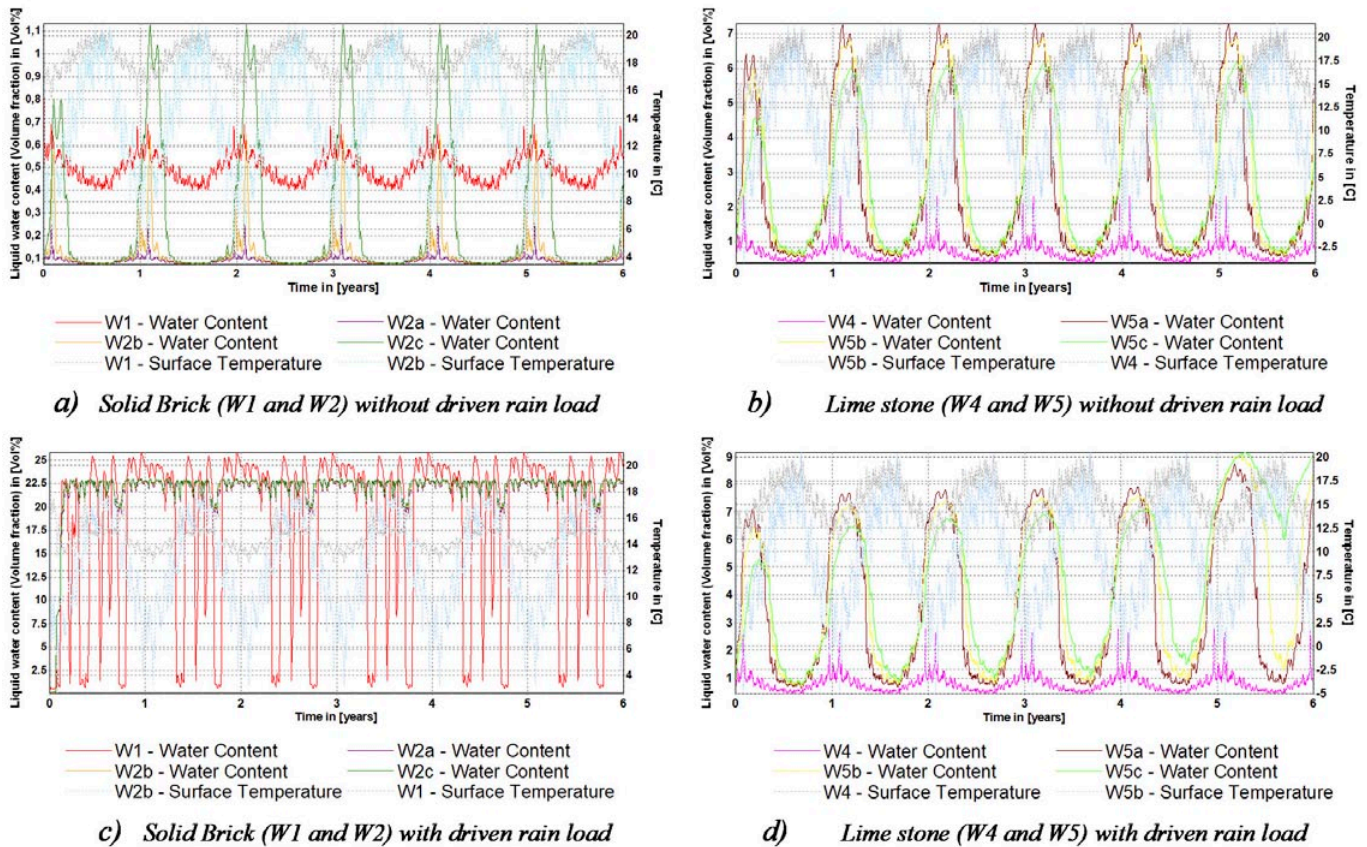

Figure 4. Water content and temperatures of W1, W2, W4 and W5 walls.

For the cases without rain (Figure 4a, 3b), the addition of the inner insulation layer shows that the thicker the ISOCAL is, the smaller the amount of water found in the brick wall; while in the lime stone the insulation increases the LWC. In dry conditions, the water content in a brick masonry wall with insulation, does not reach 0.3 %, while in a stone wall the LWC goes from 1 % to almost 7 % after ISOCAL addition. On the other hand, after driven rain (Figure 4c, 3d), the water content in the brick wall reaches almost 23 % when insulated, while the stone wall does not show major changes. However, the amount of water found at the inner insulated Brick Wall cases (W2) is always lower than at the base case (W1), without the ISOCAL addition.

These differences occur due to the hydrophilic/hydrophobic properties of the materials. Solid brick is considered a vapour permeable capillary active material, allowing liquid moisture transfer, thus facilitating the drying process. Nevertheless, liquid transfer is delayed at the lime stone wall, due to its low porosity and vapour tight system. Consequently, the presence of water in the inner layer is greater in the lime stone wall than in the solid brick wall, even if the latter presents a greater increase in its water volume in the wet scenario. However, when comparing changes in the water content within one-year interval, both cases meet the requirements of DIN 4108-3 [25], presenting changes smaller than 0.1 % in relation to the previous year. Only after a four-year simulation, the lime stone presented values above the standard's threshold.

When added to the outer layer, both the solid brick (Figure 5a) and the lime stone (Figure 5b) walls exhibited low water content, <0.09 % and <0.9 % respectively, avoiding condensation risk on the internal walls.

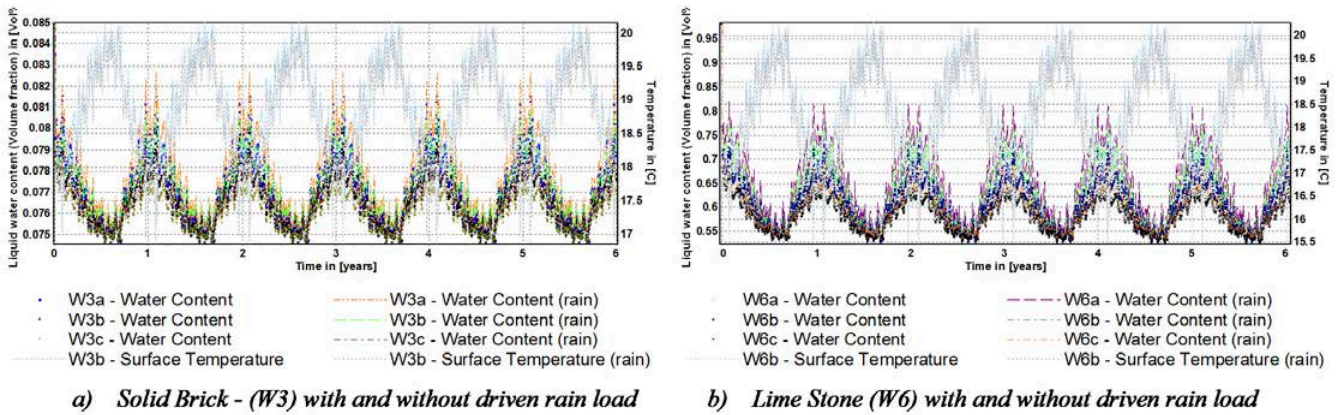

Figure 5. Water content and temperatures of W3 and W6 walls.

When analysing mould growth on the wall surface at the inner face side, specifically in the driven rain cases (Figure 6a), it was observed that the additional insulation layer decreases the risk of the phenomenon at the solid brick (W1) and at the lime stone (W4) walls. The mould growth at the base cases after the four-year simulation almost reaches an index of “2” at the brick masonry wall, meaning that several local mould growth colonies on the surface occur (microscope), and presents an index greater than “0” at the lime stone case, which may indicate an initial growth state.

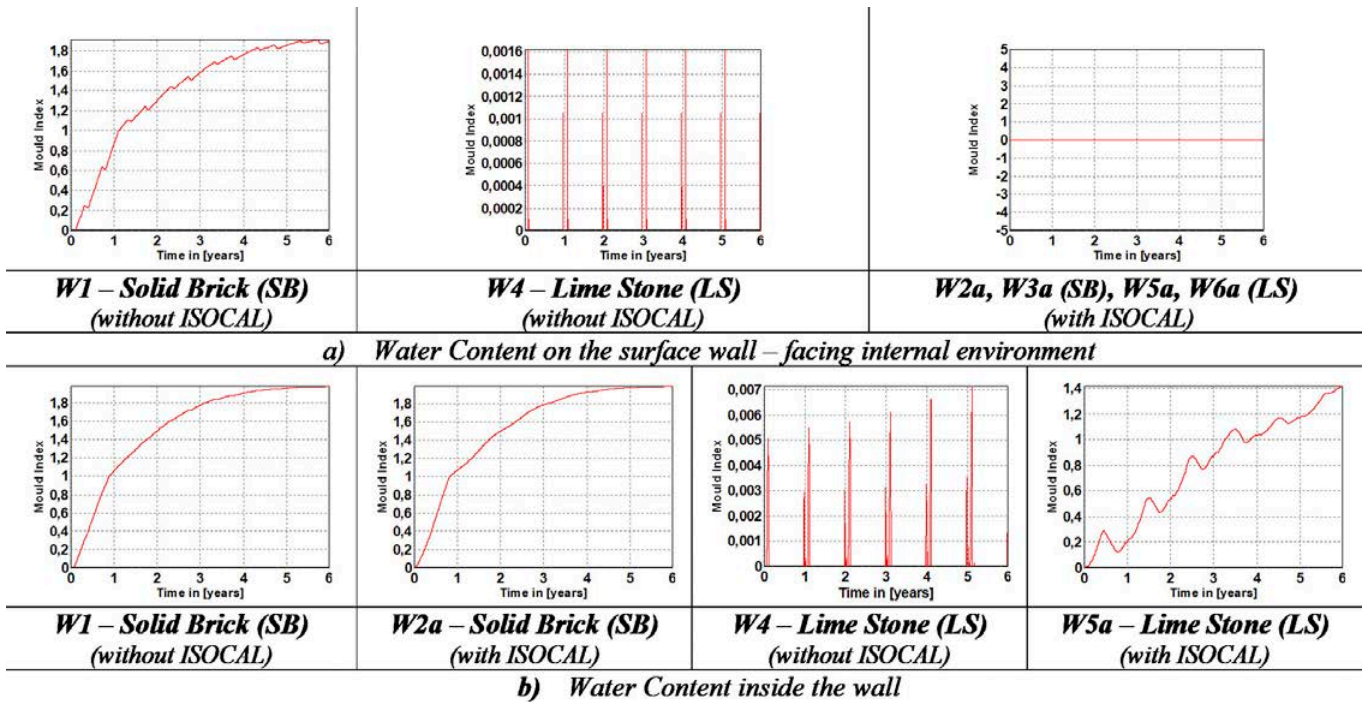

Figure 6. Progress of mould index on internal surface – cases with driven rain.

The difference in mould growth between the brick and stone walls is clearly seen in the graph lines. While the brick wall (W1), presented in Figure 6a, has an increasing linear behaviour over the years, the stone wall (W4) has an intermittent mould growth, that looks like a column graph. When assessing the mould growth inside the wall, especially at the W2 and W5 cases, where the ISOCAL was applied at the interior side of the wall (Figure 6b), it is possible to see an index greater than “1” at the stone wall (W5), and the evolution of the index on the brick wall is nearly the same.

The additional ISOCAL layer, applied to the outer or inner face of the base cases, has a mould growth index of “0”, meaning either no growth or no active spores. Despite this, the risk of mould inside the walls still exists, being inversely proportional to the thickness of the applied insulation.

4. RECOMMENDATIONS AND CONCLUSION

The ISOCAL has reasonably low thermal conductivity and high specific heat capacity, presenting at the same time vapour permeability due to its open porosity. These good insulation properties of ISOCAL contribute positively to indoor thermal comfort and energy savings. When applied to the external face of the wall, it presented a low risk of internal condensation in both studied cases. On the other hand, when used in cultural heritage refurbishments as internal insulation, its performance was affected by the envelope materials characteristics. At the simulations, when applied to the solid brick wall (W1, W2abc, W3abc), a capillary active system, the ISOCAL properties were optimized, presenting lower inner LWC in comparison to the lime stone walls (W4, W5abc, W6abc), a more vapour tight material. At the same time, the additional insulation layer, applied externally or internally, reduces the risk of mould growth on the internal surface to “0”, when the surface is free of any barriers, contributing to the building conservation and to the user’s health. However, the risk of mould inside the wall does not cease to exist after applying the insulation on the internal side, which makes it necessary to investigate the properties of the base wall prior to the internal installation of ISOCAL. Therefore, since it is a vapour permeable and capillarity active material, the ISOCAL properties are better used when combined with another system that also enables to wick liquid moisture accumulations and facilitates drying, especially when applied inside. When used as an outer coating, the concern with the base layer properties may be lower.

5. REFERENCES

- [1] S. Tadeu, C. Rodrigues, A. Tadeu, F. Freire and N. Simões, “Energy retrofit of historic building: Environmental assessment of cost-optimal solutions,” *Journal of Building Engineering*, pp. 167–176, 2015.
- [2] T. E. Commission, “Communication from the Commission to the European Parliament, the Council, the European Economic and Social Committee and the Committee of the Regions. A policy framework for climate and energy in the period from 2020 up to 2030,” Brussels, 2014.

- [3] T. Phoenix, "Lessons learned: ASHRAE's approach in the refurbishment of historic and existing building," *Energy and Buildings*, vol. 95, pp. 13–14, 2015.
- [4] L. de Santoli, "Guidelines on energy efficiency of cultural heritage," *Energy and Buildings*, no. 86, pp. 534–540, 2015.
- [5] A. Martínez-Molina, I. Tort-Ausina, S. Cho and J.-L. Vivancos, "Energy efficiency and thermal comfort in historic buildings: A review," *Renewable and Sustainable Energy Reviews*, vol. 61, pp. 70–85, 2016.
- [6] F. Berg, A.-C. Flyen, Å. L. Godbolt and T. Broström, "User-driven energy efficiency in historic buildings: A review," *Journal of Cultural Heritage*, vol. 28, pp. 188–195, 2017.
- [7] M. Filippi, "Remarks on the green retrofitting of historic buildings in Italy," *Energy and Buildings*, vol. 95, pp. 15–22, 2015.
- [8] E. Lucchi, "Thermal transmittance of historical stone masonries: A comparison among standard, calculated and measured data," *Energy and Buildings*, vol. 151, pp. 393–405, 2017.
- [9] G. Ciampi, A. Rosato, M. Scorpio and S. Sibilio, "Retrofitting Solutions for Energy Saving in a Historical Building," *Energy Procedia*, vol. 78, pp. 2669–2674, 2015.
- [10] L. Bellia, F.R. d'Ambrosio Alfanob, J. Giordano, E. Ianniello and G. Riccio, "Energy requalification of a historical building: A case study," *Energy and Buildings*, vol. 95, pp. 184–189, 2015.
- [11] D. Glew, M. Brooke-Peat and C. Gorse, "Modelling insulated coving's potential to reducing thermal bridging and moisture risk in solid wall dwellings retrofitted with external wall insulation," *Journal of Building Engineering*, vol. 11, pp. 216–223, 2017.
- [12] D. I. Kolaitis, E. Malliotakis, D.A. Kontogeorgos, I. Mandilaras, D.I. Katsourinis and F. Maria A., "Comparative assessment of internal and external thermal insulation systems for energy efficient retrofitting of residential buildings," *Energy and Buildings*, vol. 64, pp. 123–131, 2013.
- [13] P. De Berardinis, M. Rotilio, C. Marchionni and A. Friedman, "Improving the energy-efficiency of historic masonry buildings. A case study: A minor centre in the Abruzzo region, Italy," *Energy and Buildings*, pp. 415–423, 2014.
- [14] E. Vieites, V. Iana and J. Arias E., "European initiatives towards improving the energy efficiency," *Energy Procedia*, vol. 75, pp. 1679–1685, 2015.
- [15] J. Zagorskas, E. K. Zavadskas, Z. Turskisa, M. Burinskienė, A. Blumberga and D. Blumberga, "Thermal insulation alternatives of historic brick buildings in Baltic Sea Region," *Energy and Buildings*, vol. 78, pp. 35–42, 2014.
- [16] R. Walker and S. Pavía, "Thermal and hygric properties of insulation materials suitable for historic fabrics.," Madrid, 2015.
- [17] J. Woods, J. Winkler and D. Christensen, "Evaluation of the Effective Moisture Penetration Depth Model for Estimating Moisture Buffering in Buildings," National Renewable Energy Laboratory, 2013.
- [18] A.L. Webb, "Energy retrofits in historic and traditional buildings: A review of problems," *Renewable and Sustainable Energy Reviews*, vol. 77, pp. 748–759, 2017.

- [19] A. Bishara, U. Ruisinger and R. Plagge, “Hygrothermal Simulation,” in *Energy Efficiency Solutions for Historic Buildings: A Handbook*, A. Troi, Ed., 3ENCULT, 2014, pp. 105–118.
- [20] EU-FP7 Project, grant agreement no. 314678, 01.09.2012–31.08.2016, “Effesus–Energy Efficiency for EU Historic Districts Sustainability,” 2012. [Online]. Available: www.effesus.eu. [Accessed 19 December 2017].
- [21] J. Frick, M. Reichert, F. Lehmann, M. Stegmaier and K. Herter, “Moisture monitoring during an Artificial Weathering Test of a Cultural Heritage Compatible Insulation Plaster,” in *19th World. Conference on Non-Destructive Testing*, Munich, 2016.
- [22] K. Herter, *Untersuchung des Feuchteverhaltens eines neuentwickelten isolierputzsystems für historische gebäude zur validierung von EOTA-wand bewitterungsversuchen*, bachelor thesis, Stuttgart: University of Stuttgart, 2016.
- [23] MASEA, “masea-ensan.de,” Materialdatensammlung für die energetische altbausanierung, 15 April 2016. [Online]. Available: <http://www.masea-ensan.de/>
- [24] ETAG. 004:2013, *Guideline for european technical approval of external thermal insulation composite systems (etics) with renderings*, Edition 2000 ed., Vols. Amended August 2011, Amended February 2013, EOTA, 2013.
- [25] Institut für Bauklimatik, “Delphin,” [Online]. Available: <http://bauklimatik-dresden.de/delphin/index.php> [Accessed 05 January 2018].
- [26] DIN EN ISO 4108–2: 2013, *Thermal protection and energy economy in buildings – Part 2: Minimum requirements to thermal insulation*, 2013.
- [27] DIN EN ISO 4108-3: 2013, *Thermal protection and energy economy in buildings Part 3: Protection against moisture subject to climate conditions Requirements and directions for design and construction*, 2013.

Performance of interiorly insulated log wall

Experiences from Estonian cold climate conditions

T. Kalamees, E. Arumägi and Ü. Alev

Department of Civil Engineering and Architecture, Tallinn University of Technology (TTÜ), Tallinn, Estonia. Email: targo.kalamees@ttu.ee, endrik.arumagi@ttu.ee, ullar.alev@gmail.com

Abstract – Interior thermal insulation in a cold climate is risky from a hygrothermal point of view. Several measurement results have shown high risk of water vapour condensation and mould growth inside the walls in dwellings with high humidity load. Without deep hygrothermal analyse and measurement of building materials properties, the durability of interior thermal insulation as renovation solutions could be questionable. To get hydrothermally safe (no mould growth in the wall) solution, the maximum measured moisture content of logs before insulation should be below 12 percent and the thickness of interior insulation of mineral wool can be up to 50 mm. The water vapour resistance of a vapour barrier depends on the use of the house (for general living or as a summer cottage) and indoor humidity load. It is necessary to install a vapour barrier covering interior insulation carefully to avoid air leakages through it. In general, the maximum thermal resistance of an additional internal insulation layer with finishing layers, should not be above the thermal resistance of the log wall before the addition of the insulation.

Keywords – moisture safety; interior thermal insulation; hygrothermal performance; log wall; mould growth risk

1. INTRODUCTION

Historic buildings with wooden log walls have a long history and they represent a variety of building techniques employed in Estonia and in other countries in cold climate regions. Today, the building envelope of historic wooden log buildings need to be improved to save energy and increase thermal comfort. To improve energy performance of historic buildings, a possible solution to preserve their high value architectural appearance lies in interior insulation.

Interior thermal insulation in a cold climate is risky from a moisture safety point of view. In general, the risk of failure will be higher if thicker interior insulation layers are used. Ibrahim et al. [1] have shown that interior thermal insulation systems can cause several moisture problems: inability to dry out over the years, condensation risk, etc. Pasek and Kesl [2] have shown that the interior insulation of the building envelope in the climatic conditions of Central Europe is quite unsuitable because of a high probability of damage to the structural system of the building compared to other possible varieties of building envelope designs. Pasek [3] has also shown that stress increases in external walls and adjacent structures caused by non-forced effects of temperature changes in the environment after the application of internal insulation. Bjarløv et al. [4] and Finken et al. [5] have shown problems with interior insulation in masonry walls without any additional driving

rain protection. The risk of interior insulation failure means also possible mould growth in the wall structure, spread of mould spores, moisture accumulation or water vapour condensation. Spores in indoor air may cause health problems for inhabitants. A lot of the latest research is concentrated on the hygrothermal performance of wooden beam ends in an internally insulated masonry wall [6–8].

As outlined above, interior insulation is more complex and not as hygrothermally safe as the widely used exterior insulation. Increasing the thickness of an insulation layer leads to a decrease in heat loss through the external wall. Thus, it is necessary to find a solution where both the risk of failure and heat loss through walls are minimal. To achieve a moisture safe renovation solution, careful design and risk analysis are needed. This study presents a summary of several studies on hygrothermal performance of interiorly insulated wooden log walls in Estonian cold climate conditions.

2. METHODS

2.1 ON SITE MEASUREMENTS

Three field measurements were conducted [9–11] to collect information about the hygrothermal performance of interior insulation in real conditions, and to get measurement data for calibration of simulation models.

The initial log wall construction consisted of a 140–200 mm log sealed with a tow or mineral wool and covered externally with wooden cladding or not covered at all. For interior insulation several materials were used: reed insulation mat ($\lambda_{\text{reed}} \approx 0.054 \text{ W}/(\text{K}\cdot\text{m})$), cellulose insulation ($\lambda_{\text{cellulose}} \approx 0.045 \text{ W}/(\text{K}\cdot\text{m})$), mineral wool ($\lambda_{\text{mv}} \approx 0.040 \text{ W}/(\text{K}\cdot\text{m})$), and reflective composite mat insulation ($\lambda_{\text{ri}} \approx 0.016 \text{ W}/(\text{K}\cdot\text{m})$). In addition to thermal conductivity, materials differed also by water vapour permeability and moisture storage properties.

The values of temperature, relative humidity (RH), and heat flux were measured over a one year period at one hour intervals. The following sensors were used: temperature sensors (TMC6-HD; measurement range: $-40^\circ \dots +100^\circ \text{C}$, accuracy: $\pm 0.25^\circ$) with HOBO•U12–013 data loggers; temperature and RH sensors (Rotronic HygroClip?SC05 $\varnothing 5\text{mm} \times 51\text{mm}$, measurement range: $-40^\circ \dots +100^\circ \text{C}$ and $0 \dots 100\%$, accuracy: $\pm 0.3^\circ \text{C}$ and $\pm 1.5\%$); and heat flux plates (Hukseflux HFP-01-05, measurement range $\pm 2000 \text{ W}/\text{m}^2$, accuracy: $\pm 5\%$). Measurement results were saved with a Grant Squirrel SQ2020 data logger. Temperature and RH inside and outside the building were measured with data loggers (Hobo U12-013; measurement range $-20 \dots +70^\circ \text{C}$; $5 \dots 95\%$ RH, with an accuracy of $\pm 0.35^\circ \text{C}$; $\pm 2.5\%$ RH).

2.2 SIMULATIONS

Hygrothermal simulations were made with the WufiPro (WUFI) software. The calculation model was composed in a WUFI simulation tool. The program introduces two potentials for moisture flow: the liquid transport flux depends on RH and the water vapour diffusion flux depends on vapour pressure. Heat and

moisture convection is not calculated. The air flow is calculated in a simplified way, as air change between studied layer and indoor/outdoor air.

The calculation model was validated [10,12,13] by choosing the materials best matching those used in the measured structure from the default WUFI database, and by slightly modifying the default material properties according to information identified in literature.

An Estonian moisture test reference year [14], critical in terms of mould growth in Estonia, was used for the outdoor climate after a validation of the model with the measured outdoor climate. The indoor temperature reference level is based on measurement results from previous studies [15–17], where the average indoor temperature during a cold period is presented.

3. RESULTS AND DISCUSSION

3.1 FIELD MEASUREMENTS

3.1.1 A historic wooden apartment building

The RH on the inner surface of the log wall stayed at the high level during the whole measurement period. Based on the mould growth model [18] in all the cases, the temperature and RH level inside the wall exceeded the temperature and relative humidity (RH) conditions favouring initiation of mould growth on wooden materials, see Figure 1. Mould was detected also visually when walls were opened for repair.

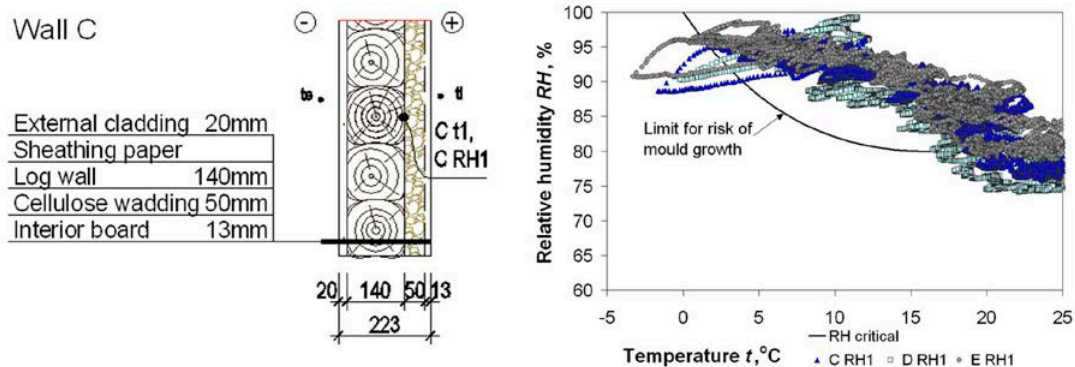

Figure 1. One section from six studied test walls (left) and temperature and RH conditions that are favourable for mould growth between log and insulation.

The test walls studied were located in apartments with high humidity loads. This was caused mainly due to high moisture production (high occupation density by a family of seven, basement walls and floor were opened to living rooms) and low air change rate (natural ventilation) because the ventilation system was not renovated. In addition, high initial moisture content (the building was not used and heated for many years before renovation) was one possible reason for the high humidity level.

3.1.2 Field measurements in a historic wooden rural house

The purpose of the second study was to compare the thermal performance of traditional mineral wool (MW; thickness of 66 mm, $\lambda_{MW} \approx 0.04 \text{ W}/(\text{m}\cdot\text{K})$) and a thin-layer reflective insulation (RI; thickness of 10 mm + 2×25 mm air layer, $R_{RI} \approx 5.70 \text{ m}^2\text{K}/\text{W}$) systems on internally insulated log walls (Figure 2, A / B). The room was heated with electrical convector. The room was not humidified. The measurement period was divided into two parts: seven months with the interior heated, and seven months with the interior unheated (free-floating climate).

As the measured temperatures and heat flux through both test walls were almost equal, the thermal performance of 66 mm wool insulation and 10 mm reflective composite mat insulation with air cavities on both sides, was similar. The thermal resistance of 10 mm reflective composite mat insulation was lower than declared by the producer in advertisements.

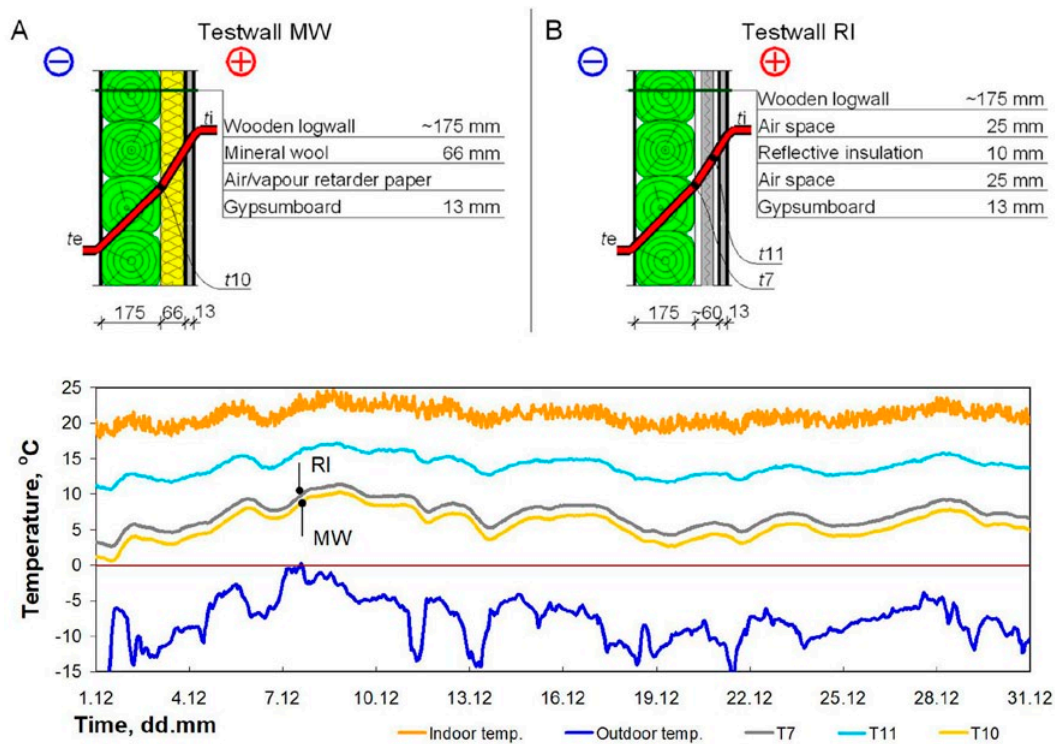

Figure 2. Hourly temperatures during December (above) and the distribution of monthly average temperatures in test walls.

3.1.3 Field measurements in a new test house

The field measurements were carried out in a small house (room with a net area of 18 m²) specially designed and built for testing. One wall was insulated internally with three different materials: mineral wool, cellulose fibre (both covered with vapour retarder and gypsum board) and reed mat with clay plaster. The purpose was to compare hygrothermal performance of different insulation materials as well as to compare the influence of drying out moisture on different interior insulation materials.

The RH level of different materials was different due to different construction methods (Figure 3). Insulation with cellulose fibre was most critical, because it was installed by a wet spray method. While the cellulose was covered with water vapour barrier, the drying out of moisture was also slow (about six months). The reed mat itself was dry, but the added plaster layer added a significant amount of water into the insulation layer, therefore the RH was high during the first month. The drying process was faster than in the cellulose fibre part, because the water vapour resistance of the clay layer is much lower than the resistance of the PE-membrane used for water vapour barrier on the cellulose fibre and on the mineral wool part. The mineral wool part had no additional moisture during installation, and therefore the RH level was low at the beginning of the measurements. The RH level increased because the moisture dried out from the logs. The RH in the reed mat in summer was about 10 % lower than in the mineral wool and cellulose fibre. This was caused because reed was plastered and allowed better moisture dry out to the room. In the mineral wool and cellulose fibre part the moisture mainly dried out to the external side due to air convection through the log wall, which is much more intensive during the cold period (beginning from November).

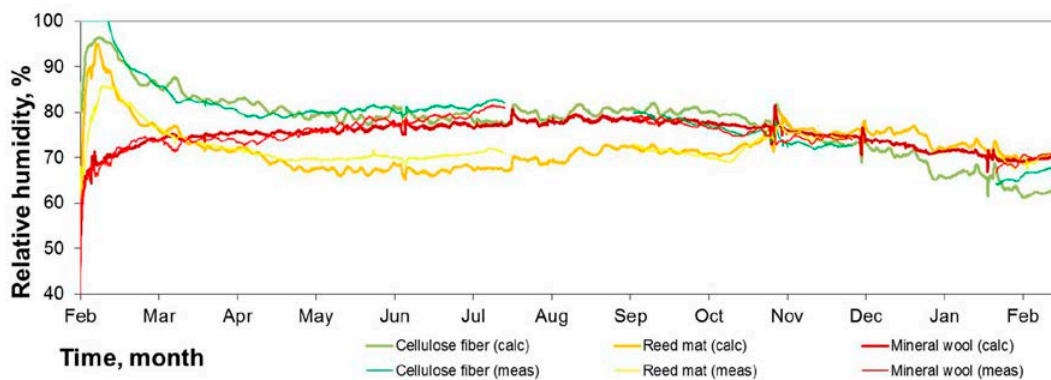

Figure 3. Measured and calculated RH on the inner surface of the log wall showed good agreement between calculations and measurements.

3.2 SIMULATIONS

3.2.1 Stochastic approach

Using a stochastic approach, the performance of the interior insulation as a retrofit measure in a historic wooden apartment building was analysed by varying the following input data parameters: outdoor climate conditions, indoor climate loads, different retrofitted wall assemblies, and quality of workmanship. The Monte Carlo method was used for sampling input variables according to their probabilistic distributions characteristics. The mould growth index is considered as the performance indicator for risk assessment. All together 486 combinations were generated and WUFI simulations were performed to check whether an unwanted outcome ($M\ index < 1$ that means no mould growth) occurs or not [19].

As a result of success ($M\ index < 1$) and failures ($M\ index \geq 1$), it was found that the unwanted outcome occurred in 17 cases and 83 of the cases were safe

(Figure 4). In 17 cases out of 100, a statistical probability of interior insulation failure is 17 %. For a 30 year calculation period, the unwanted outcome occurred in 26 cases, and 74 of the cases were safe. Statistical probability failure is 26 %.

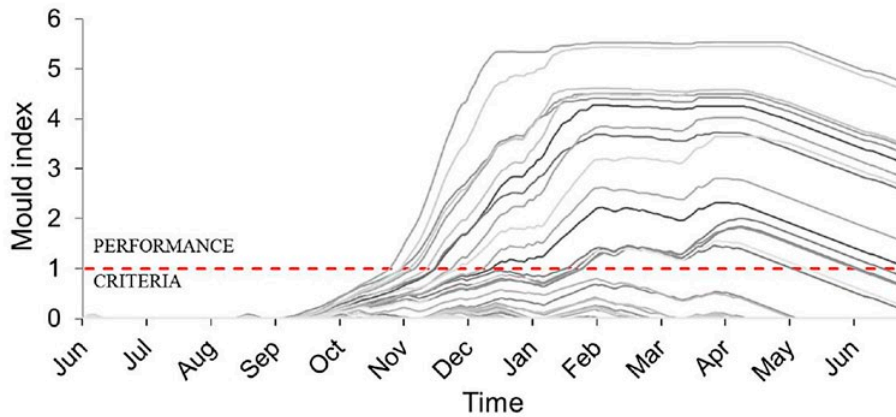

Figure 4. Calculated mould index between log and interior insulation layer of randomly generated 100 cases for one year period.

To find the relation between the regressions analysis and the *M index*, the combinations of input variables generated for the first step WUFI simulations were used. The correlation between the calculated *M indexes* and the probabilities of a solution to function without failure of randomly generated 100 calculation cases are presented in Figure 5. To assess the reliability, the boundary between safe and failure can be drawn in the intersection of the assessment criteria line and the probability line. The average probability for a solution to function without failure is 86 % in the 0.95 confidence intervals 64 % to 100 %. Based on the stochastic calculations, it can be said that if the safety margin is set on the lower 0.95 confidence level, then the statistical probability of failure for the 50 mm thick interior insulation on the 145 mm thick log wall in typical indoor and outdoor climate conditions in Estonia, is 36 %.

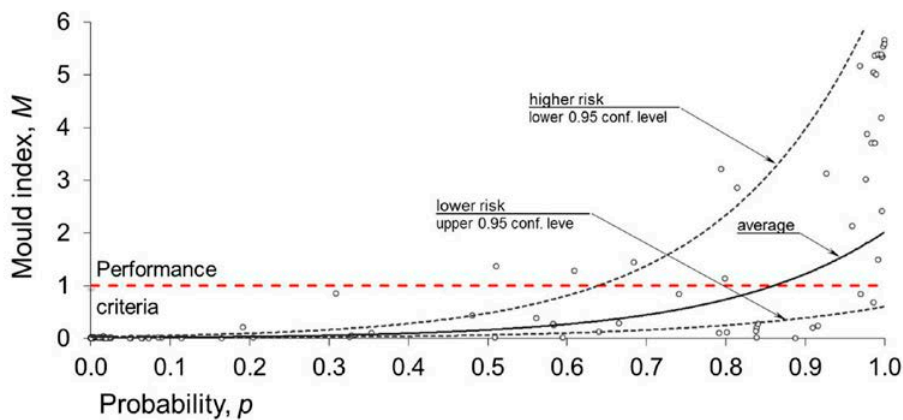

Figure 5. Correlation between the mould index and the probability of a solution to function without failure.

3.2.2 Deterministic approach

A parametric study was conducted [20] to analyse the risk of mould growth on the critical surface: the inner surface of a log by varying following input data parameters: indoor humidity load, average indoor temperature during winter, thickness of a log wall, thickness of additional insulation, initial moisture content of logs (MC), vapour diffusion thickness of air, and vapour barrier. A period of five years calculated with the moisture test reference year, was considered long enough to achieve stable yearly hygrothermal variations with most of the calculated combinations. All together more than 360 combinations were generated, and WUFI simulations were performed.

Based on simulations, we can order the main parameters based on the effect on mould growth risk between log wall and insulation (starting from the highest):

1. water vapour resistance of the vapour barrier;
2. indoor moisture load;
3. thermal transmittance of the interior insulation layer;
4. initial MC of logs;
5. thickness of logs, i.e. the thermal resistance of the original wall; and
6. indoor temperature level.

The vapour barrier in a heated house should be $S_d > 10$ m in case of MC of log up to 16 % or if thicker insulation layer is desired and at least 2 m when the relative MC of logs is up to 14 %. In unheated houses, $S_d = 2$ m is the maximum acceptable level when logs have MC up to 17 % at the time of insulation.

4. CONCLUSIONS

This article summarises several studies conducted to find hygrothermally safe solutions for interior insulation as an energy renovation measure for historic buildings.

In the worst case scenarios, mould growth was detected inside the internally insulated log wall. Therefore, special attention should be paid, when interior thermal insulation is under consideration for energy renovation of historic buildings.

Calibration of the hygrothermal simulation model, and measurement of original wall material, are needed in most cases. Therefore we recommend to conduct field measurements on smaller wall parts before full scale renovation.

The main conditions and parameters required in order to avoid mould growth risk in an interiorly insulated log wall in cold climate, are as follows:

- The water vapour resistance of a vapour barrier depends on the use of the house and its indoor humidity load; therefore, the choice of an appropriate material should be based on the values indicated in [20], or else calculations are required in each individual case;
- The thermal resistance of additional internal insulation layer can be more than double of the thermal resistance of the present log wall if all following criteria are fulfilled: better vapour barrier with effective sealing, lower indoor moisture

- excess is guaranteed with effective performance of ventilation, hygrothermal calculation for specific case is made, and increased risk of mould in the wall can be tolerated;
- Before insulation, a log wall has to be as dry as possible, i.e. at the measured initial average moisture level of $MC \leq 12\%$ if mineral wool with a vapour-tight barrier is used;
 - It is necessary to ensure the airtightness of a wall, and especially the vapour barrier covering the interior insulation; any penetrations (electric installations, etc.) are unacceptable;
 - It is necessary to guarantee the required ventilation and heating in a house by means of reliable technology.

Changing the water vapour resistance of a vapour barrier or indoor moisture load, was found to have the biggest effect on the mould growth index, whereas the average thickness of logs and indoor temperature levels had a small effect on the mould growth index. This means that the choice of the right vapour barrier, and its careful installation, together with low (controlled) indoor moisture loads, are the primary conditions to avoid mould growth in an interiorly insulated log wall.

5. ACKNOWLEDGEMENTS

This research was supported by the Estonian Centre of Excellence in Zero Energy and Resource Efficient Smart Buildings and Districts, ZEBE, grant TK146 funded by the European Regional Development Fund, and by the Estonian Research Council with Institutional research funding grant IUT1–15.

6. REFERENCES

- [1] M. Ibrahim, E. Wurtz, P.H. Biwolé, P. Achard, H. Sallee, Hygrothermal performance of exterior walls covered with aerogel-based insulating rendering, *Energy Build.* 84 (2014) 241–251. doi:10.1016/j.enbuild.2014.07.039.
- [2] J. Pasek, P. Kesl, Probabilistic assessment of failure risk of the building envelope thermally insulated from the inside, *Appl. Math. Comput.* 267 (2015) 108–118. doi:10.1016/j.amc.2015.05.080.
- [3] J. Pašek, Impact of Internal Thermal Insulation Systems on Static Behaviour of Exterior Walls, *Adv. Mater. Res.* 649 (2013) 11–14. doi:10.4028/www.scientific.net/AMR.649.11.
- [4] S. Bjarløv, G. Finken, T. Odgaard, Retrofit with Interior Insulation on Solid Masonry Walls in Cool Temperate Climates – An Evaluation of the influence of Interior Insulation Materials on Moisture Condition in the Building Envelope, *Energy Procedia.* 78 (2015) 1461–1466. doi:10.1016/j.egypro.2015.11.171.
- [5] G.R. Finken, S.P. Bjarløv, R.H. Peuhkuri, Effect of façade impregnation on feasibility of capillary active thermal internal insulation for a historic dormitory – A hygrothermal simulation study, *Constr. Build. Mater.* 113 (2016) 202–214. doi:10.1016/j.conbuildmat.2016.03.019.
- [6] M. Guizzardi, J. Carmeliet, D. Derome, Risk analysis of biodeterioration of wooden beams embedded in internally insulated masonry walls, *Constr. Build. Mater.* 99 (2015) 159–168. doi:10.1016/j.conbuildmat.2015.08.022.

- [7] M. Harrestrup, S. Svendsen, Internal insulation applied in heritage multi-storey buildings with wooden beams embedded in solid masonry brick façades, *Build. Environ.* 99 (2016) 59–72. doi:10.1016/j.buildenv.2016.01.019.
- [8] M. Morelli, S. Svendsen, Investigation of interior post-insulated masonry walls with wooden beam ends, *J. Build. Phys.* 36 (2012) 265–293. doi:10.1177/1744259112447928.
- [9] E. Arumägi, S. Ilomets, T. Kalamees, T. Tuisk, Field study of hygrothermal performance of log wall with internal thermal insulation., in: V.P. Freitas, H. Corvacho, M. Lacasse (Eds.), *Int. Conf. Durab. Build. Mater. Components. Proc.*, Faculty of Engineering University of Porto, Porto, 2011: pp. 811–819.
- [10] Ü. Alev, T. Kalamees, E. Arumägi, S. Ilomets, Comparison of thermal performance of mineral wool and reflective insulation on internally insulated log wall, in: *Proc. Heal. Build. 2012*, Queensland University of Technology, Brisbane, 2012.
- [11] Ü. Alev, A. Uus, T. Kalamees, Comparison of Mineral Wool, Cellulose and Reed Mat for Interior Thermal Insulation of Log Walls, *J. Civ. Eng. Archit. Res.* 2 (2015).
- [12] E. Arumägi, T. Kalamees, Validation of a Simulation Model for Hygrothermal Performance of Log Wall with Internal Thermal Insulation in Cold Climate, in: *Proc. 5th IBPC*, Kyoto, 2012: pp. 345–352.
- [13] Ü. Alev, T. Kalamees, M. Teder, M.-J. Miljan, Air leakage and hygrothermal performance of an internally insulated log house, in: J. Arfvidsson, L.-E. Harderup, A. Kumlin, B. Rosencrantz (Eds.), *NSB 2014 10th Nord. Symp. Build. Phys.*, 15–19 June 2014, Lund, Sweden, Sweden, 2014: pp. 55–62.
- [14] T. Kalamees, J. Vinha, Estonian Climate Analysis for Selecting Moisture Reference Years for Hygrothermal Calculations, *J. Build. Phys.* 27 (2004) 199–220. doi:10.1177/1097196304038839.
- [15] Ü. Alev, T. Kalamees, L. Eskola, E. Arumägi, J. Jokisalo, A. Donarelli, K. Siren, T. Broström, Indoor hygrothermal condition and user satisfaction in naturally ventilated historic houses in temperate humid continental climate around the Baltic Sea, *Archit. Sci. Rev.* 59 (2015) 53–67. doi:10.1080/00038628.2015.1038980.
- [16] E. Arumägi, T. Kalamees, U. Kallavus, Indoor climate conditions and hygrothermal loads in historic wooden apartment buildings in cold climates, *Proc. Est. Acad. Sci.* 64 (2015) 146–156. doi:10.3176/proc.2015.2.03.
- [17] S. Ilomets, T. Kalamees, J. Vinha, Indoor hygrothermal loads for the deterministic and stochastic design of the building envelope for dwellings in cold climates, *J. Build. Phys.* (2017). doi:doi: 10.1177/1744259117718442.
- [18] A. Hukka, H.A. Viitanen, A mathematical model of mould growth on wooden material, *Wood Sci. Technol.* 33 (1999) 475–485. doi:10.1007/s002260050131.
- [19] E. Arumägi, M. Pihlak, T. Kalamees, Reliability of Interior Thermal Insulation as a Retrofit Measure in Historic Wooden Apartment Buildings in Cold Climate, *Energy Procedia.* 78 (2015) 871–876. doi:10.1016/j.egypro.2015.11.010.
- [20] Ü. Alev, T. Kalamees, Avoiding mould growth in an interiorly insulated log wall, *Build. Environ.* 105 (2016). doi:10.1016/j.buildenv.2016.05.020.

Investigations on the influence of different types of restoration of beam ends of the floor in the Alte Schäfllerei Benediktbeuern

M. Krus, A. Thiel and R. Kilian

Institute for Building Physics (IBP), Holzkirchen, Germany

Abstract – The Alte Schäfllerei (Old Cooperage) of Benediktbeuern Monastery houses the Fraunhofer Centre for Conservation and Energy Performance of Historic Buildings. This historical building is renovated as an object of observation in the sense of a “transparent construction site” both from a preservation and an energy point of view. The opening of the wooden beam ceiling of the Alte Schäfllerei showed that almost all wooden beam heads were massively attacked by wood destroying fungi and harmful insects, and therefore had to be replaced. A total of 24 destroyed wooden beam heads were found. This gave us the opportunity to investigate various restoration techniques within a research project. Different renovation variants were used, which differ in the material of insulation, in the type of bearing and in the handling of the cavities around the beam head. The influence of the different measures is shown by means of the measured temporal courses of the wood moisture near the surface and in the core of the beam heads. Additionally, the temperature at the end of some of the beams have been recorded to support the assessment of the different restoration techniques.

Keywords – wooden beam restoration; monitoring; assessment

1. INTRODUCTION

1.1 BACKGROUND OF THE INVESTIGATIONS

More than 100 years ago, Stade [1] dealt extensively with wooden beam heads and recommended air gaps around the wooden beams, connected with outside and inside air. Recent studies on wooden beam heads are mostly related to internal insulation measures (e.g., [2]). In this case, a heating of the beam head is proposed again and again. This leads to a reduction of wood moisture, but measurements also show that the moisture without heating lies in higher but still uncritical humidity ranges (12–19 % by mass). The protection against driving rain has the greatest impact on the moisture behaviour of the wooden beam heads; only in cases where proper rain protection cannot be reached, heating may be recommendable. According to Peylo [3], for heated rooms, the gap between wooden beam heads should be filled with insulation, not only to prevent heat losses but also for acoustic reasons. Up to now no measurements can be found that compare different types of restoration of wooden beams and their influence on the moisture content, and therewith the risk of wood destroying organisms. This was the reason for starting investigations in the Alte Schäfllerei (Old Cooperage).

The aerial photograph in Figure 1 shows the monastery Benediktbeuern with the Alte Schäfllerei (Old Cooperage) from the second half of the 18th Century. Since 2010, it houses the Fraunhofer Centre for Conservation and Energy Performance of Historic Buildings. The historic building is being restored as a visual object as a “transparent construction site” in terms of its monumental scale, as well as the energy aspects. Various measures such as interior insulation, wall heating or the renovation of beam heads, are accompanied by extensive research projects.

When opening the wooden beam ceiling of the Alte Schäfllerei it turned out that almost all wood beam heads were massively attacked by wood-destroying fungi and insect pests. This offered the opportunity to try out different restoration techniques at the Alte Schäfllerei, and to accompany them by measurement.



Figure 1. Aerial view of the monastery complex with the Alte Schäfllerei (red circle).
Photo: Fraunhofer Institute for Building Physics IBP.

2. PROCEDURE OF THE INVESTIGATIONS



A total of 24 destroyed wooden beam heads were renovated. Different types of renovation were carried out, which differed above all in the type of insulation, in the support below and in the cavities around the beam head (Table 1).

Variant 1, the so-called common halving, represents the most common type of beam head renovation. Here, the damaged area of the wooden beam head was replaced by new wood. A mortar bed serves as a support, around the beam head a mineral wool insulation is located in variant 1a, in variant 1b an air gap. In variant 2, the destroyed wooden beam head is cut off and a metal panel attached to it, resting as a new wall support on a mortar bed. Around the metal, a box made of plasterboard filled with mineral wool is erected (see Figure 3). In addition, an uninsulated variant 2 b was executed. Variant 3 differs from variant 1b in the type of support. The use of a highly insulating hydrophobic aerogel mat (nanogel)

prevents any relevant thermal or hygric contact with the masonry. In variant 4a thermal contact is given by the use of an elastomer support but no hygric contact. The additional variant 4b was executed without an air gap around the beam head. Variant 5 is characterized by the fact that the beam head is insulated with aerogel mats all-around (Figure 4). In variant 6, a 5 mm thick copper plate is applied on the upper side as an artificial thermal bridge (Figure 5), which is angled ahead to cover the front side of the beam head. This copper plate extends about 50 cm into the room.

Figure 6 shows the location of the ceiling beams. In bold, black font the restoration variant is indicated, and above in blue the naming of the respective wooden beam. For all wooden beams, the wood moisture was measured by hand, both near the surface and at depth at regular intervals. For each restoration variant on the north side, the beam head temperature on the front side was recorded, except for variant 2.

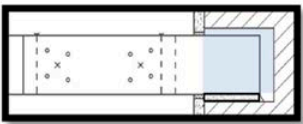
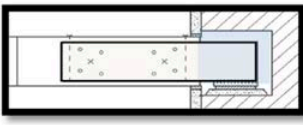
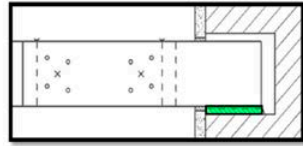
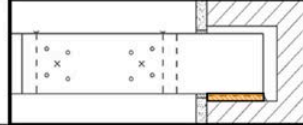
Table 1. Chosen restoration variants for the wooden beam heads with different supports, insulation designs and resulting thermal and hygric characteristics. The type of built-in sensors is listed additionally

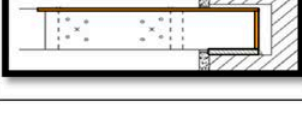
Schematic View	Type	Support	Insulation	Characteristics of the Support	Sensors
	Common Halving	Mortar Bed	a) on all sides b) none	Good thermal and hygric Contact	Wood Moisture; Temperature
	Metal Panel	Elastomer	a) on all sides b) none	Good thermal and hygric Contact	Wood Moisture
	Common Halving	Nanogel	none	Neither thermal nor hygric Contact	Wood Moisture; Temperature
	Common Halving	Elastomer	a) none b) none, + without air gap	Good thermal and hygric Contact	Wood Moisture; Temperature
	Common Halving	Nanogel	on all sides	Neither thermal nor hygric Contact	Wood Moisture; Temperature
	Common Halving + Copper Plate	Mortar Bed	none	Good thermal and hygric Contact	Wood Moisture; Temperature

As part of the energy refurbishment, the outer surfaces of the first floor were provided with internal insulation. Here, too, the installation was accompanied by a research project with the aim to develop novel reversible internal insulation for heritage preservation [4]. The spectrum of the chosen insulating materials ranges from traditional to innovative: on the inner walls of the Schöfflerei, traditional reed mats can be found as well as capillary-active mineral foam panels, with the idea to transport condensate back into the interior. Two high performance aerogel insulation plasters and an aerogel mat were also included in the investigations, as well as a plate insulation material from cattail (lat. Typha), developed at the Fraunhofer Institute for Building Physics together with the architect and inventor Werner Theuerkorn. In addition to these slabs or plaster insulating materials, loose-fill and blow-in insulations have been applied on the south side, using dry wall constructions. Figure 7 shows the location of the different interior insulation systems with details of the insulation material and the installation time.



Figure 2. Variant 1 with common halving, mortar bed and insulation mounted around the beam head. Photo: Fraunhofer Institute for Building Physics IBP.

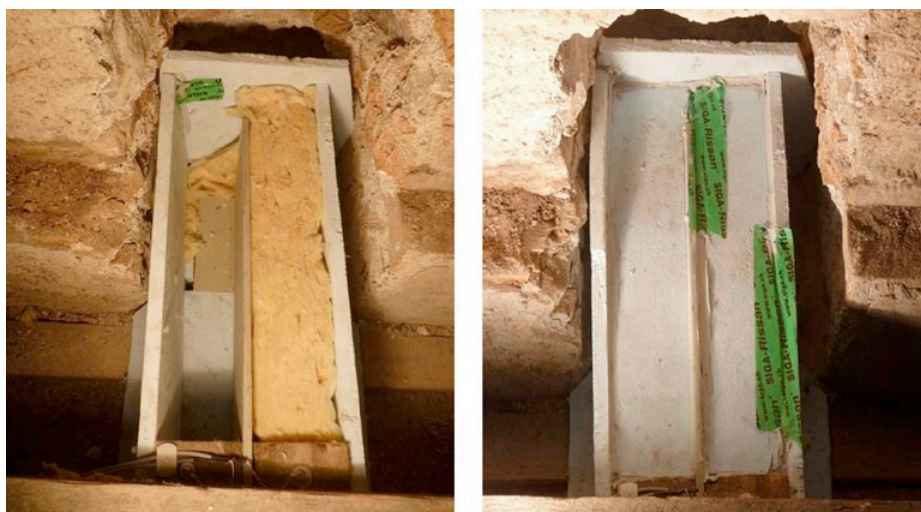

Figure 3. Construction of a box around the metal panel of variant 2, which is filled with mineral wool (left) and then closed (right). Photo: Fraunhofer Institute for Building Physics IBP.



Figure 4. Variant 5 with common halving, aerogel mat around the beam head and as support. Photo: Fraunhofer Institute for Building Physics IBP.



Figure 5. Variant 6 with a copper plate as an artificial thermal bridge. Photo: Fraunhofer Institute for Building Physics IBP.

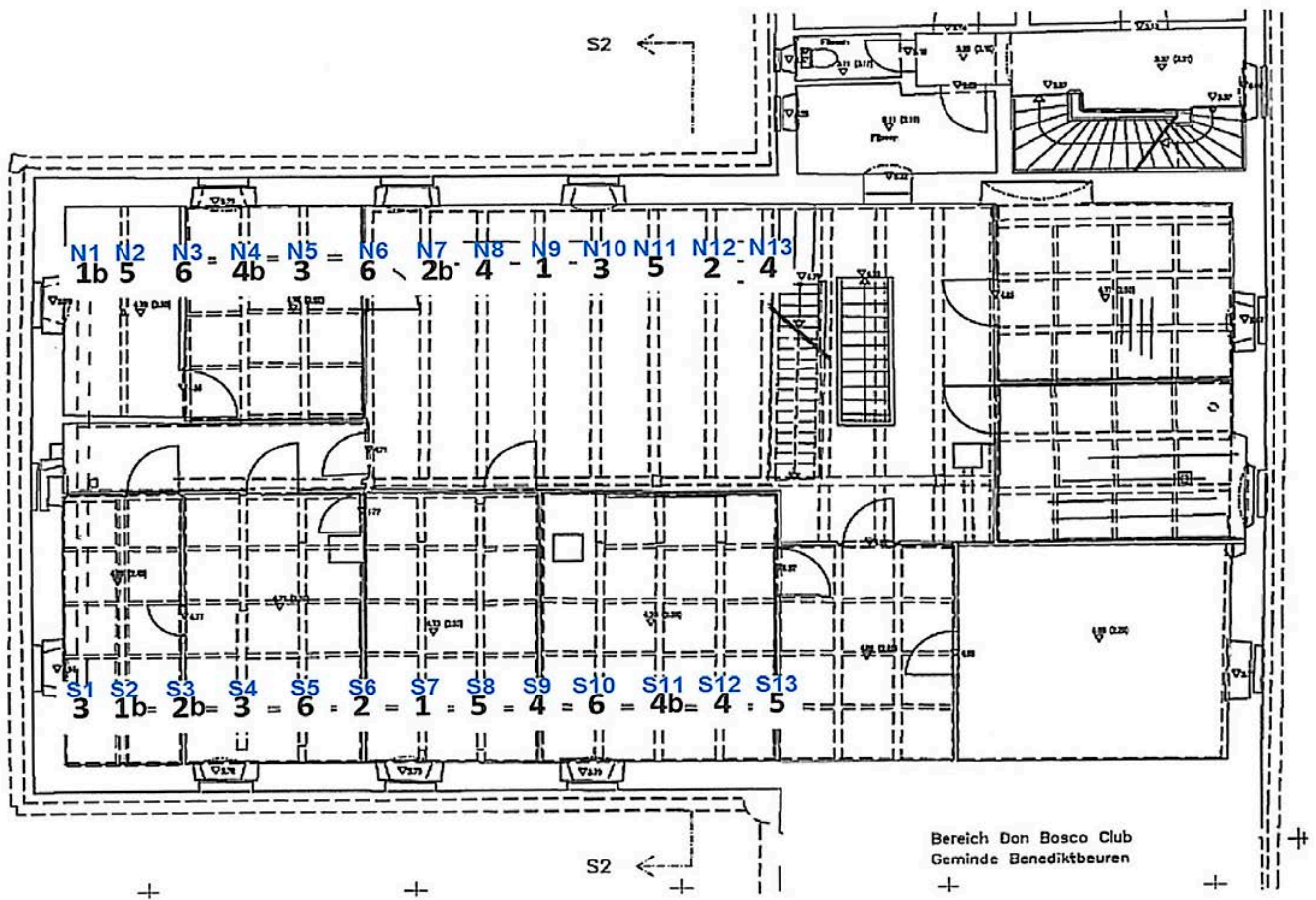

Figure 6. Location of the ceiling beams with indication of the associated restoration variant (black numbers) and naming of the beams (blue inscription).

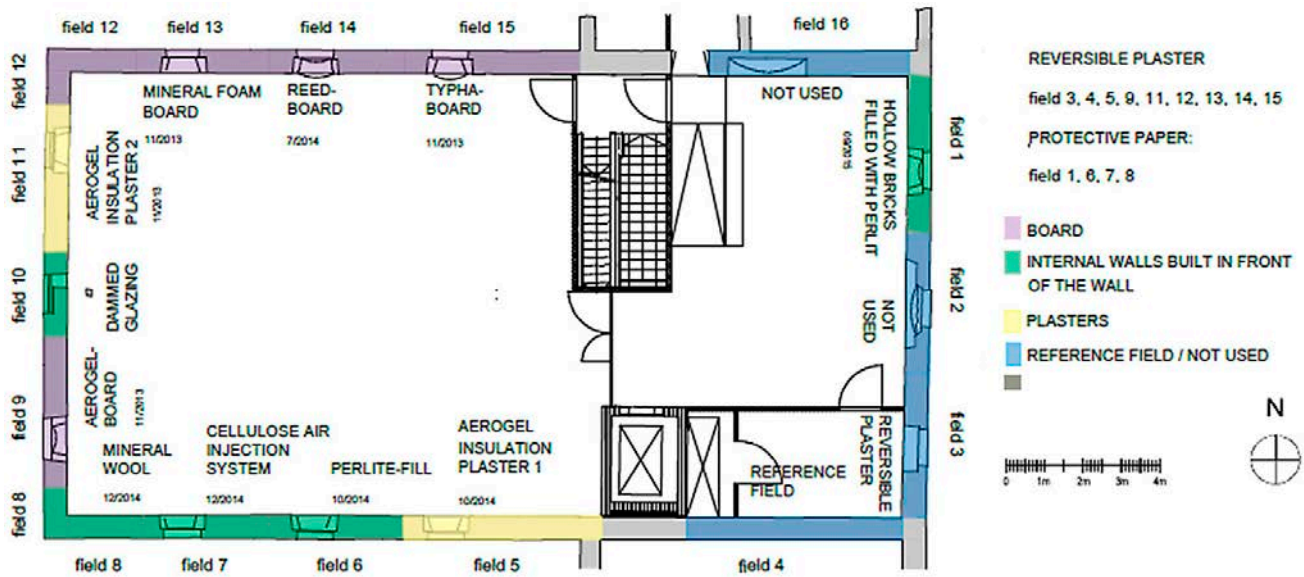

Figure 7. Interior insulation systems installed in the old cooperage with details of the insulation material and the installation time.

3. RESULTS OF THE INVESTIGATIONS

The measured courses of wood moisture are displayed over the entire measurement period of four years. The period of installation of the renovated wooden beam heads (until mid-May 2012, including the closing of the openings) is highlighted in light blue and the time from the start of heating (from mid-November 2013) orange. The shaded area indicates that the interior was humidified to a constant 50 % relative humidity. The dates of the installation of the interior insulation systems, as well as the renovation of the external plaster to reduce the driving rain absorption of the west façade, are also marked. The marking of the measuring points is carried out analogously to the numbering in Figure 6 (eg N1-N13) with subsequent indication of the restoration variant (1–6) and the measuring location (HFO = wood moisture surface, HFT = wood moisture in depth). The variants showing striking moisture behaviour are considered more closely and the probably responsible causes described. Figure 8 shows the course of the measured wood moisture near the surface (top) and in the core area (below) for all renovated wooden beam heads on the north side.

Looking at the near-surface moisture content of the wood, it can be seen that the initial moisture content lies between approx. 20 and 30 % by mass. Striking are the variants N4/4/HFO, N5/3/HFO and N12/2/HFO. For variant N4/4b/HFO and N5/3, the initial increase in wood moisture is likely caused by the high built-in moisture (see Figure 9). Variant N12 2 is the restoration variant with metal panel. Here already at the beginning a high wood moisture of more than 40 % by mass is measured and there is no noticeable drying over a longer period, whereby surprisingly large humidity fluctuations occur.

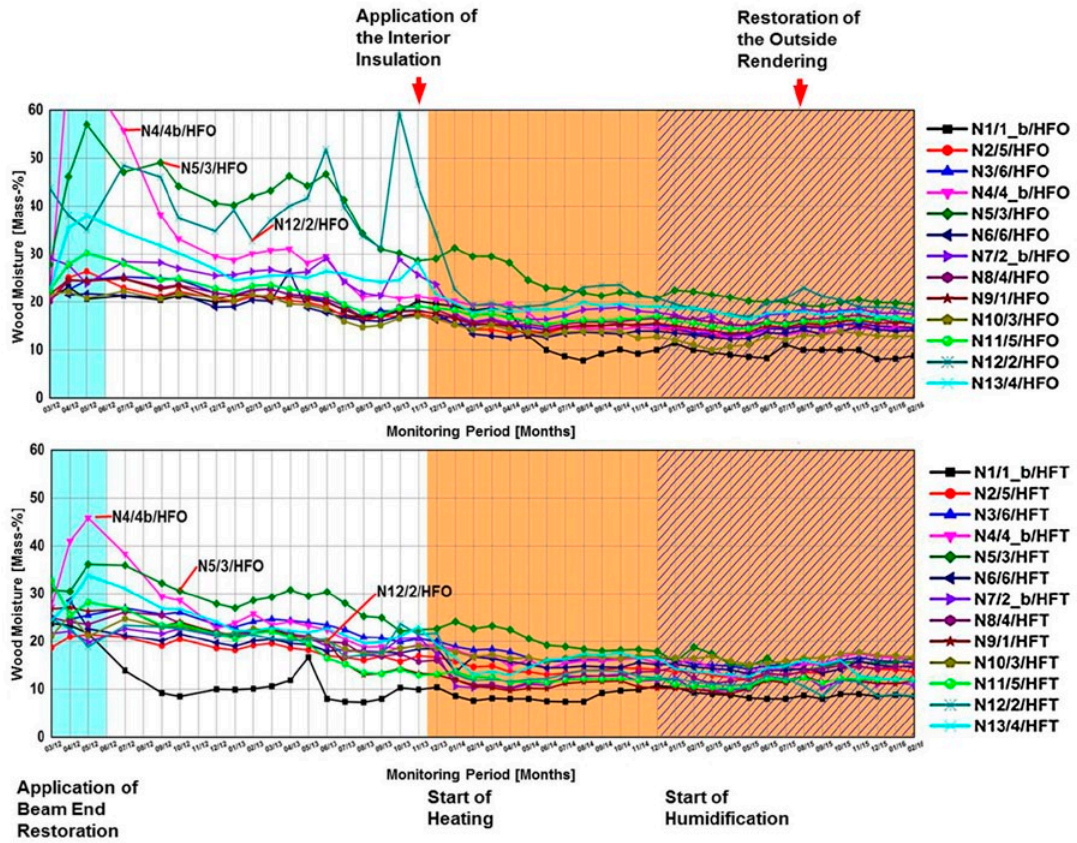

Figure 8. Courses of the wood moisture measured at the beam heads for the near-surface area (top) and the core area (below) on the north side.



Figure 9. Variant N4/4b with fresh mortar in direct contact to the beam head (left) and. variant N5/3 with a lot of built in mortar (right). Photos: Fraunhofer Institute for Building Physics IBP.

In the unheated period, all beam heads, with the exception of the three variants mentioned above, dry up to wood moisture content of 20 % by mass and below. In November 2013, the mineral capillary-active insulation board and the typha board were applied to the north-facing wall. The moisture introduced during the application is noticeable in most beam head variants by a slight increase in the measured moisture content of the wood.

A significant increase can be seen in the measured surface moisture of N12/2 and N7/2, both variants provided with the metal panel. This is due to the fact that the end of the wood is still within the interior and reacts strongly and quickly to the high rise in the humidity of the room caused by the application of interior insulation. With the beginning of heating a subsequent slight decrease in wood moisture takes place. The changed behaviour of N12/2 at the surface moisture is striking. It now joins the other and shows no more noticeable fluctuations in contrast to before.

On the south side (see Figure 10), two beam heads are particularly noticeable in their behaviour. The beam head S11/4b shows a strong increase in wood moisture, which is also caused by the high built-in moisture. In the interior of the beam head, the same behaviour results in slightly reduced extent. With the beam head S13/5, the wood moisture increases slowly but significantly over a longer period. The root cause analysis showed that a leaking downpipe of the roof gutters is responsible for this behaviour. After the repair of the downpipe, drying seems to be very slow.

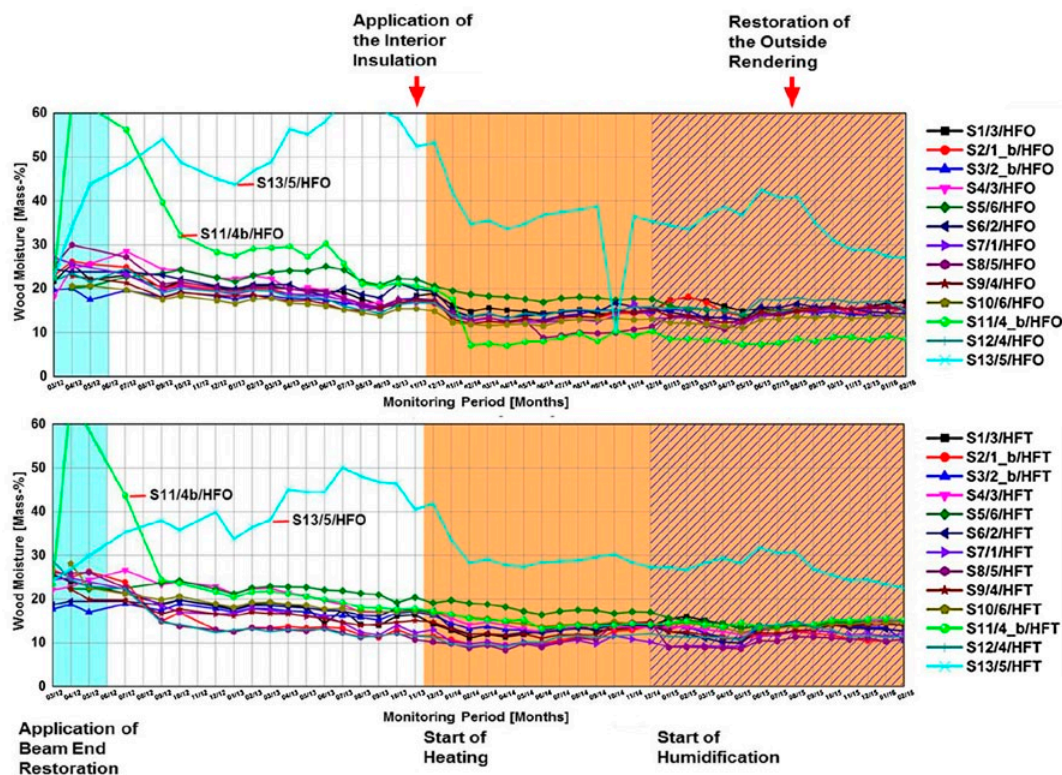

Figure 10. Course of the wood moisture measured at the beam heads for the near-surface area (top) and the core area (bottom) on the south side.

Overall, on the south side, the situation is similar to that on the north side, with somewhat lower levels of humidity as expected. Here, too, a slight increase in humidity is to be observed with the beginning of the installation work for the interior insulation in October/November 2013, although at this time on the south side, no interior insulation was installed. This shows that the primary humidifying mechanism was the increased humidity of the room due to the installation of the internal insulation. Consequently, it is true that the installation of the aerogel plaster on the south side in October 2014 as a moisture increase has noticeable effect, but not the installation of drywall variants with cellulose blowing insulation and perlite in December 2014.

For verification, the water content in the beam head was calculated with WUFI®-2D for three of the variants [5]. There are noticeable differences only in the first one to two years (Figure 11), which are due to the different initial moisture contents. This agrees well with the described measurement results.

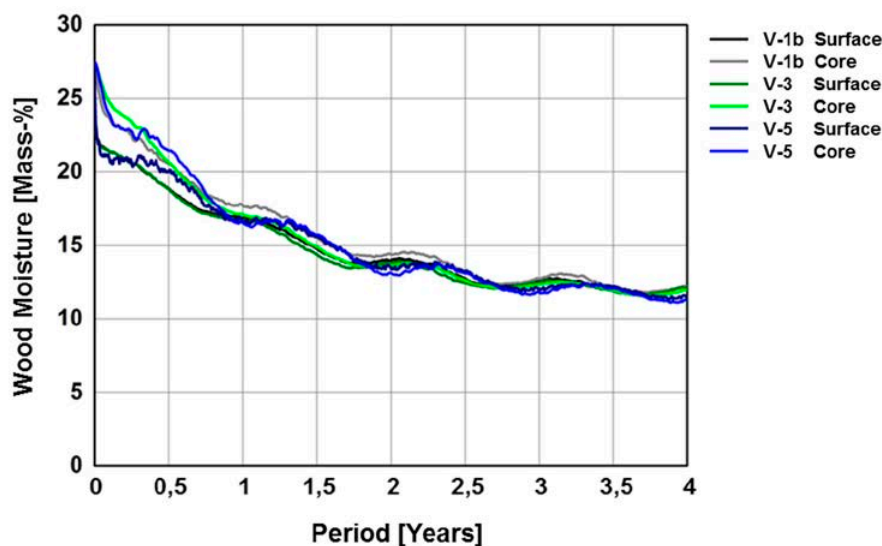

Figure 11. Course of the wood moisture of the three restoration variants calculated with WUFI®-2D for a period of 4 years after installation.

4. SUMMARY

At the Alte Schöfflerei at the monastery in Benediktbeuern, it was possible to try out different restoration techniques and to accompany them by monitoring. The restoration variants carried out differ mainly in the type of the supports of the beam head, and the insulation in the cavities surrounding them.

It was found that with the beginning of the application of the internal insulation in October/November 2013, a slight increase in humidity was observed in the wooden beam heads on the south side, although at this time on the south wall, no internal insulation was installed. This shows that the primary humidification mechanism was caused by the increased indoor air humidity due to the installation of the interior insulation on the north side. As a result, the installation of

the aerogel plaster on the south side in October 2014 is noticeable by a moisture increase at the beam head, but not the installation of the drywall variants with cellulose blown-in insulation and perlite loose-fill in December 2014. Beside the mentioned short-term moisture increase, almost all beam heads on the south side dry up continuously with time and reach a moisture content well below 20 % by mass. They are expected to be slightly lower than on the north side, but low non-critical wood moisture have been measured there as well.

Overall, the results show that the influence of the different support variants and lateral insulation of the beam head is significantly less pronounced than expected. There are noticeable differences only in the first one to two years, but these are mainly due to the different initial moisture of the various beam heads caused by local structural peculiarities or previous damages. After that, there are hardly any major differences between the different variants studied, apart from small temporal shifts. The anticipated clear influence of the type of beam head renovation appears to be given only to a very small extent, and is rather of minor importance compared to the influence of the inhomogeneities of the wall structure. For all beam heads, in the longer term, despite the high wintery moisture load of 50 % relative humidity in the room even after installation of the internal insulation completely uncritical water contents are measured. However, this also shows that the hygrothermal situation at the beam head is much less critical than expected, provided that adequate rain protection from the outside is given as an essential prerequisite and no relevant backside flow with warm, humid indoor air occurs. The frequently found massive damage to beam heads should thus be caused in most cases by insufficient rain protection of the façade, as well as in temporary local massive moisture loads from damages, such as leaky roofs or rainwater drainage.

5. REFERENCES

- [1] F. Stade: Die Holzkonstruktionen- Stand der Erkenntnisse (The wooden constructions – state of knowledge). Reprint der Originalausgabe von 1904, Bechtermünz Verlag München, 1997.
- [2] D. Kehl: Holzbalkenköpfe im Mauerwerk (Wooden beam heads in masonry). *Holzbau* 6/2012; Page 20–25.
- [3] A. Peylo: Der Balkenkopf – wie macht man ihn nun richtig? (The wooden beam head – how to do it in the right way?) *Schützen & Erhalten*, Sept. 2007 Page 18–21, Fachzeitschrift des Deutschen Holz- und Bautenschutzverbands e.V. (DHBV).
- [4] R. Kilian; M. Krus; Ch. Milch; St. Bichlmair; A. Thiel, and D. Rösler: "EnOB–Energetische Untersuchungen und Optimierung von Innendämmungen" (EnOB–Energetic investigations and optimization of internal insulation. IBP-report. Carried out on behalf of the Federal Ministry for Economic Affairs and Energy. Fraunhofer Institute for Building Physics IBP, Holzkirchen.
- [5] H.M. Künzel: Simultaneous heat and moisture transport in building components. One- and two-dimensional calculation using simple parameters. PhD Thesis, University of Stuttgart (1994).

Investigation of post-insulated walls with wooden beam ends

Risk analysis for different insulation techniques

J. Borderon, E. Héberlé, A. Cuny and J. Burgholzer

Centre for studies and expertise on risks, environment, mobility and urban and country planning (Cerema), Strasbourg, France. Email: julien.borderon@cerema.fr; elodie.heberle@cerema.fr; antoine.cuny@cerema.fr; Julien.burgholzer@cerema.fr

Abstract – More and more traditional buildings are undergoing thermal insulation and airtightness improvement. The impact of thermal insulation scenarios on the hygrothermal balance of traditional walls has been investigated in several publications. In this study, the focus is on wooden beam ends embedded into interior thermal insulation. In the context of the East of France, cellulose wadding with smart vapour barrier, glass wool with smart vapour barrier and expanded polystyrene have been added to a brick façade with a wooden beam. Dynamic simulations show the impact of the airtightness of these solutions, the impact of a wooden spacer between the beam and the masonry, the impact of the choice of insulation techniques and the impact of the external coating on the risk of wood decay.

Keywords – traditional wall retrofitting; hygrothermal performance; thermal insulation; hygrothermic dynamic simulation

1. INTRODUCTION

1.1 THERMAL INSULATION IN TRADITIONAL BUILDINGS

While the French law for energy transition has reinforced the insulation requirements of existing buildings and set a significant pace for energy retrofitting (500,000 housings per year), it is important to promote a “responsible” rehabilitation approach for traditional buildings, allowing them to preserve their architectural and cultural values and avoid pathologies potentially generated by the works.

In the north east of France, energy consumption for the heating needs is the highest in the country and the social context means that the region has serious issues with fuel poverty. Public programmes promote different renovation measures with financial assistance, and thermal insulation is one of these [1]. A third of the housing stock in the region is composed of traditional buildings. Researchers and technical teams have proposed guides to help to avoid “unfortunate renovation” such as the publication “*Habitat ancien en Alsace*” [2].

The impact of thermal insulation scenarios on the hygrothermal balance of traditional walls has been investigated in several publications and tools such as ISOLIN for bricks walls [3]. In the present study, the focus is on one problematic issue with interior insulation: wooden beam ends. The objectives of the work were to assess the risks described in the scientific literature on French cases to

support the technical recommendations for traditional buildings. Comparisons between different configurations and calculated moisture risks could provide useful learning materials for building professionals.

1.2 WOODEN BEAM ENDS AND THERMAL INSULATION IN THE LITERATURE

In their literature review, Kehl *et al.* [4] confirmed that before insulation, in historical buildings, damage to wooden beam ends is essentially due to lack of maintenance, such as damaged downpipes, leaking roofs and lack of protection against wind-driven rain, or poor material properties.

Concerning wooden beam ends with interior insulation, the literature review states the following points:

- Air connection from the room to the air gap around the beam ends could have a great impact on the relative humidity of the wood, as published by Ruisinger [5];
- The sensitivity of masonry to wind-driven rain is the major factor of risk of decay at the wooden beam end. [4] [6];
- To cut off capillarity transfers between the beam end and the masonry, a hard wooden spacer or a bituminous membrane could be used in Germany in historic buildings. [5] This is not usual in France;
- In some situations, it appears preferable to stop the insulation in a zone around the wooden beams to avoid a large temperature drop and avoid condensation and wood decay as presented in Denmark by Morelli and Svendsen [7].

1.3 FIELD OBSERVATIONS IN THE EAST OF FRANCE

Interior thermal insulation usually has a minimum thermal resistance of $3.7 \text{ m}^2 \cdot \text{K}/\text{W}$ as required to obtain public financial assistance. The main insulation techniques consist of expanded polystyrene, glass or mineral wool with a vapour barrier, wood wool or cellulose wadding with a vapour barrier. Other techniques such as VIP panels or capillary active systems are still relatively rare. It is still possible to find renovation with glass or wood wool without any vapour barrier but use of the latter is spreading. The most highly promoted vapour barrier type is the “smart” vapour barrier with diffusion resistance depending on humidity.

A measurement campaign was performed [8] but without specific wooden beam assessment. However, airtightness around the beam in the vapour barrier plane was checked. Special tapes were used in all cases to tie the vapour barrier to the beam, but the following flaws have been noticed:

- The vapour barrier does not always pass through the wooden floor and is taped on only three faces of the beam;
- The smoke test still shows leakage around the beam ends.

2. SIMULATION METHOD

2.1 CHARACTERISTICS OF THE MODELS

The dynamic calculation program Wufi 2D based on the Kunzel model [9] was used to investigate the behaviour of wooden beam ends in cases built

according to the literature review and field observations. Figure 1 shows the configuration.

A solid brick wall with an external coating and a gypsum plaster on the inside is the basis configuration. Three different solutions for internal thermal insulation are applied to add the same resistance of $3.7 \text{ m}^2 \cdot \text{K}/\text{W}$:

- Glass wool, 12 cm thick plus a smart vapour barrier (sd from 0.2 to 26 m);
- Cellulose wadding, 14 cm thick plus a smart vapour barrier (sd from 0.2 to 26 m);
- Expanded polystyrene, 14 cm thick.

The 15 mm thick external coating could be a lime plaster or a cement lime plaster. Cement plaster was ruled out due to reasons of incompatibility with historic masonry.

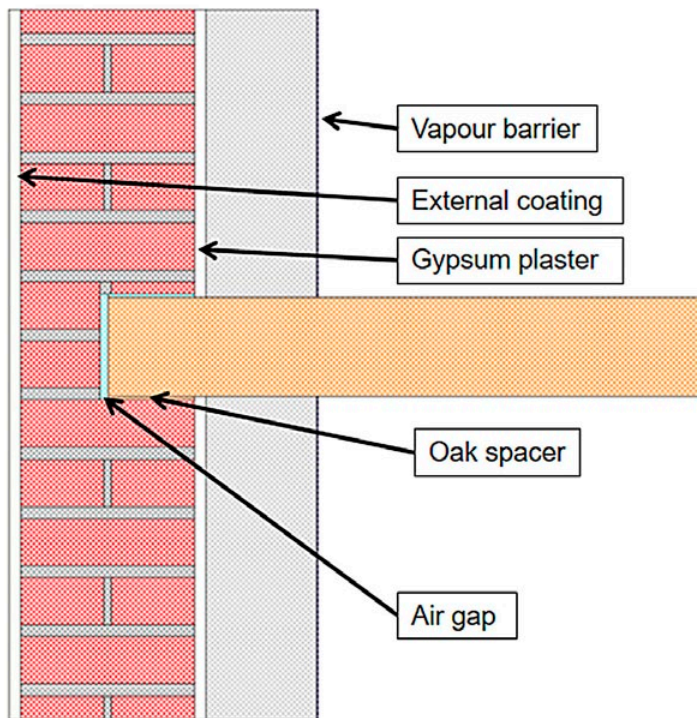

Figure 1. Configuration for the simulations.

Table 1 gives a description of the material properties used for the simulations. The outdoor climate is “Nancy” from Meteonorm, which is the usual representation for the north-east of France except for mountainous areas. The indoor climate was set according to EN 15026 with a normal humidity level. Considering wind-driven rain, the basic value of 70 % for the adhering fraction of rain was fixed for all the simulations.

Table 1. Material characteristics in the models

Materials	Bulk Density [kg/m ³]	Porosity [m ³ /m ³]	Specific Heat Capacity. Dry [J/kgK]	Thermal Conductivity. Dry. 10°C [W/mK]	Water Vapour Diffusion Resistance Factor [-]	Water content W80 [kg/m ³]	Water Absorption Coefficient [kg/m ² s ^{1/2}]
Historic solid brick	1800	0.31	850	0.6	15	4.5	0.36
Cement Lime Plaster	1900	0.24	850	0.8	19	45	0.017
Lime Plaster	1600	0.3	850	0.7	7	30	0.05
Glass Wool	32.5	0.95	840	0.032	1	-	-
Cellulose Wadding	50	0.95	2 110	0.037	1.8	7.9	0.204
Expanded Polystyrene	14.8	0.99	1470	0.036	73.01	0.12	-
Wood beam	650	0.47	1 500	0.13	200	98	-
Oak spacer	685	0.72	1400	0.13	140	115	0.0007
Lime Mortar	1700	0.35	850	0.8	14.75	12.07	0.087
Air Layer	-	-	-	-	-	-	-
Gypsum / Plaster	1721	0.305	850	0.2	13	1766	0.303
Vapour Barrier	115	0.086	2500	2.4	26,000	6.6	-

2.2 AIR INFILTRATION AROUND THE BEAM AND FLAWS IN THE VAPOUR BARRIER

2.2.1 Air infiltration around the beam

To represent air leakage between the room and the air layer around the beam end in the model, a calculation was made to determine an hourly airflow rate applied as an air change rate per hour in the air layer. According to the publication by Walker [10], the air flow rate is expressed in equation 1.

$$Q = C \times \Delta P^n \quad (1)$$

C is a constant and n depends on the turbulence of the flow; n is equal to 1 in the case of laminar flow. Kalamees *et al.* have proposed values for C and n in [11] and [12]. For lack of special tape to seal the vapour barrier, 0.188 for C and 0.777 for n, were measured.

ΔP , the differential pressure, is estimated hourly according to the method in WTA 6–2 [13]. No pressure from a mechanical ventilation system was added as suggested and a conventional floor height of 2.5 m was used to calculate the stack effect.

2.2.2 Realistic airtightness

Perfect airtightness of the insulation material, composed of expanded polystyrene panels or insulation with a vapour barrier is not realistic. WTA 6–2 [13] propose a method to calculate a realistic moisture source behind the insulation layer when the insulation work has been done with “normal care”.

This method was applied and moisture sources have been calculated and integrated into the gypsum plaster just behind the insulation material. These sources are reasonably small, as they represent only small flaws in the

airtightness and not major defects such as a break in the vapour barrier or the lack of joining tape between polystyrene panels.

2.3 RESULT ANALYSIS METHOD

Simulation was performed over a 10-years period and the final years are presented in the results section. Results are given for two façades: the north oriented façade for the lack of sun radiation and the south-west oriented façade for the strong wind-driven rain. Focus is on the following points:

- Indicator A: The part of the wood beam in contact with the spacer or directly with the masonry: the water content as a mass ratio should remain strictly below 30 % and must not exceed 20 % for a total of 8 weeks per year;
- Indicator B: The end of the wood beam in contact with the air layer: the same as previously;
- Indicator C: Relative humidity at the boundary between the insulation and the gypsum plaster: the higher the relative humidity, the higher the mould growth risk;
- More indicators could be useful, such as the risk of freezing but in this study only the three mentioned here are presented.

3. RESULTS AND DISCUSSIONS

3.1 GENERAL RESULTS.

The three solutions for insulation with the two different external coatings and the two orientations were combined to perform 12 simulations with the two infiltration models described in 2.2. A second set of simulations were made without air leakage between the beam end and the room but with a realistic airtightness of the insulation solution. The third set is the same as the second but with a perfectly airtight insulation solution.

On the three sets of simulations, indicator A never exceeds the threshold values but some cases could be close to 20 % of content by mass. This is for the north façade, without an oak spacer and with air leakage around the beam (1st set of simulations). Indicator B exceeds the 20 % by mass threshold for all cases in the first set of simulations, but not in the second and third sets. This indicator is dependant on the airtightness of the insulation solution around the beam. Indicator C changes mainly according to the insulation techniques. The results may represent a risk of mould development in the first and the second simulation sets, especially with expanded polystyrene.

In the followings sections, all the results presented are from the first set of simulations except in 3.2 where the three sets are compared. All simulations are with the hard wood spacer except in 3.1 where its impact is assessed.

3.2 HARD WOOD SPACER BETWEEN THE BEAM END AND THE MASONRY

The oak spacer is used to reduce the capillary absorption of water and in this case the water content at the beam support is reduced by 7 % for both façades.

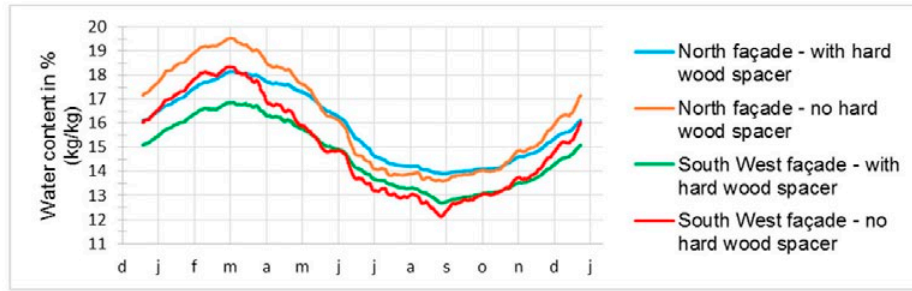

Figure 2. Impact of the oak spacer on indicator A for a configuration with lime plaster as external coating and cellulose wadding as insulation material.

3.3 IMPACTS OF AIR INFILTRATION AND VAPOUR BARRIER FLAWS

Airtightness around the beam has a clear impact on both indicators A and B. The beam end is more humid with air leakage from the room, especially in winter. In the case shown in figure 4, there is a risk of mould development as the mass water content exceeds 20 % throughout most of the winter. The global airtightness of the insulation solution has a clear impact on indicator C.

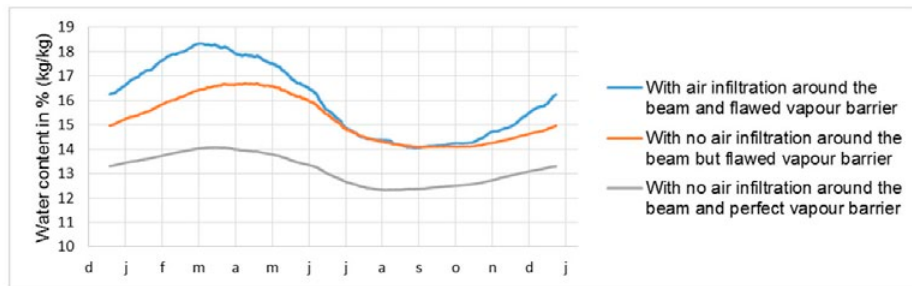

Figure 3. Impact of air infiltration around the beam end and of realistic flaws in airtightness for a configuration with cement lime plaster as external coating and cellulose wadding as insulation material. (Indicator A)

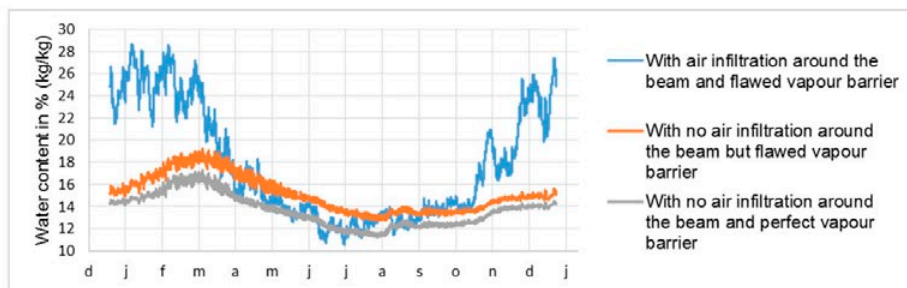

Figure 4. Impact of air infiltration around the beam end and of realistic flaws in airtightness for a configuration with cement lime plaster as external coating and cellulose wadding as insulation material. (Indicator B)



Figure 5. Impact of air infiltration around the beam end and of realistic flaws in airtightness for a configuration with cement lime plaster as external coating and cellulose wadding as insulation material. (Indicator C)

3.4 NATURE OF THE THERMAL INSULATION IMPACTS

The results on the south-west façade and the north façade are similar. Figures 6 and 7 show indicators A and C for the north.

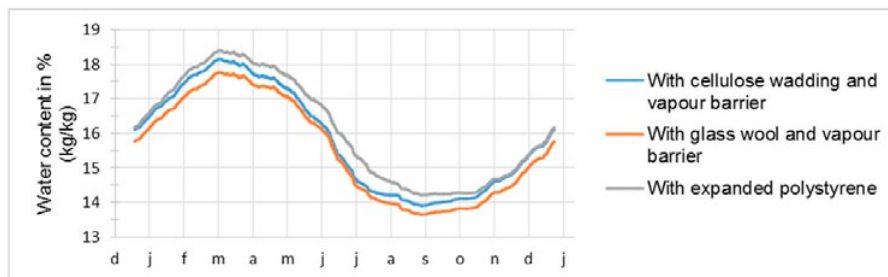

Figure 6. Indicator A with the 3 different insulation scenarios for the configuration with lime plaster as external coating and north façade.



Figure 7. Indicator C with the 3 different insulation scenarios for the configuration with lime plaster as external coating and north façade.

Indicator B shows no difference between the insulation scenarios. Concerning the wooden beam end, the differences due to the properties of the insulation material are small and polystyrene is the worst solution. At the boundary between the insulation layer and the gypsum, it is more humid with polystyrene. Drying in summer is not possible via the inner surface of the wall.

3.5 OUTSIDE COATING

On both façades, the differences on indicator A comparing cement lime plaster and lime plaster are small with all insulation scenarios. Figure 7 shows the results with cellulose wadding. It is the same for indicator B. According to the literature, a total lack of external rendering would have made a significant difference. Another explanation could be that the climate of Nancy is not a very harsh from the stand-point of wind-driven rain compared to the Atlantic coastal region for instance.

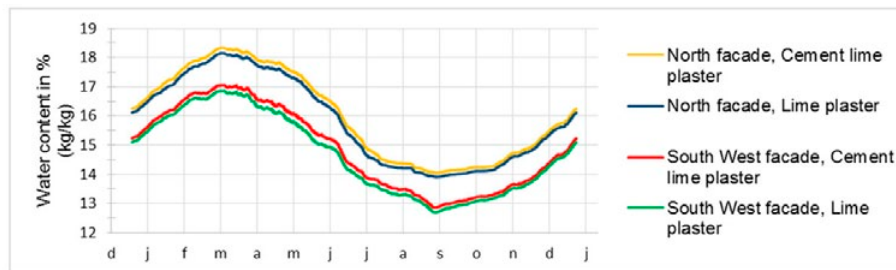

Figure 8. Indicator A with variation of the external coating for the configuration with cellulose wadding.

4. CONCLUSIONS

Investigations on the risks of decay of wooden beam ends embedded into interior thermal insulation in solid brick buildings in the east of France, confirm the recommendations in the literature. Airtightness around the beam and the quality of the work with the vapour barrier have a significant impact on the humidity of the wood and could lead to wood decay at the end of the beam. In the configurations analysed, the water content in the sensitive part of the wood beam is high and this shows that a proper study should be performed before insulating traditional buildings with wooden beams. Finally, when comparing the most common insulation solutions, expanded polystyrene is the worst solution compared to vapour-open glass wool or hygroscopic and vapour-open cellulose wadding. The results of this study contribute to a guidance for French craftsmen on the retrofitting of traditional walls known as OPERA. The work will continue for other wall types and insulation techniques, such as hard stones or wood wool.

5. ACKNOWLEDGEMENTS

This research was supported by the French Ministries in charge of sustainable development and housing through the national PACTE programme.

6. REFERENCES

- [1] DREAL Grand Est. “Living better: a social energy efficiency refurbishment programme”. Internet: www.grand-est.developpement-durable.gouv.fr/IMG/pdf/habiter-mieux-anglais.pdf, Sep 23, 2016 [Feb 28, 2018].
- [2] DREAL Grand Est and DRAC Alsace. “Habitat ancien en Alsace : énergie et patrimoine”. Internet: <http://www.grand-est.developpement-durable.gouv.fr/pour-comprendre-et-renover-le-bati-ancien-en-a193.html>, Jan 1, 2016 [Feb 2, 2018].
- [3] A. Evrard, A. Branders, A. De Herde, M. Glineur, M. Grégoire. (Oct, 2010) “Isolation thermique par l’intérieur des murs existants en briques pleines”. [On-line] Available: https://energie.wallonie.be/servlet/Repository/guide_isolin_oct2010_web.pdf?IDR=13751 [Feb 28, 2018].
- [4] D. Kehl, U. Ruisinger, R. Plagge, J. Grunewald. “Wooden beam ends in masonry with interior insulation – a literature review and simulation on causes and assessment”. Conference proceedings 2nd Central European Symposium of Building Physics, Vienna, 2013, 299–304.
- [5] U. Ruisinger. “Risikofaktor Balkenkopf? – Holzbalkendecken und die Innendämmung.” Conference proceedings 2. Internationaler Holz[Bau] Physik-Kongress 2011, Aköh, Herford.
- [6] M. Guizzardi, J. Carmeliet, D. Derome. “Risk analysis of biodeterioration of wooden beams embedded in internally insulated masonry walls”. *Construction and Building Materials*, vol. 99, 159–168, 2015.
- [7] M. Morelli, S. Svendsen. “Investigation of interior post-insulated masonry walls with wooden beam ends”. *Journal of Building Physics*, vol. 36, 265–293, 2012.
- [8] J. Borderon, P. Nussbaumer, J. Burghozer. “On-site assessment of hygro-thermal performance of historic walls before and after retrofitting with insulation”. Conference proceedings 2nd International Conference on Energy Efficiency and Comfort of Historic Buildings, Bruxelles, Belgium, 2016.
- [9] H.M. Künzle. “Simultaneous Heat and Moisture Transport in Building Components: One- and Two-dimensional calculations using simple parameters”, PhD thesis at Fraunhofer-IBP, Stuttgart, 1995.
- [10] I.S. Walker, D.J. Wilson, M. Sherman. “A comparison of the power Law to quadratic formulations for air infiltration calculation”. *Energy and building*, vol. 27, 293–299, 1998.
- [11] T. Kalamees, J. Kurnitski. “Moisture convection performance of external walls and roofs”. *Journal of building Physics*, vol. 33, 225–247, 2010.
- [12] T. Kalamees, J. Kurnitski. “Moisture convection performance of walls and attic floor joints”. Conference proceedings Nordic Symposium on building physics, Copenhagen, Denmark, 2008.
- [13] WTA 6–2 Simulation of heat and Moisture Transfer. Stuttgart, Germany: WTA, Wissenschaftlich-Technische Arbeitsgemeinschaft für Bauwerkserhaltung und Denkmalpflege e.V. Dec. 2014. 30p.

Removable textile devices to improve the energy efficiency of historic buildings

V. Pracchi, E. Rosina, A. Zanelli and C. Monticelli

Dept. ABC, Politecnico di Milano, Italy. Email: valeria.pracchi@polimi.it

Abstract – The paper aims to present innovative studies concerning removable devices for enhancing thermal performance or mitigating criticalities in listed buildings. The first concerns a “high tech” curtain studied for preventing air drafts from the windows, causing different forms of decay in the Sala delle Asse in Castello Sforzesco (Milano), world known for the Leonardo Da Vinci fresco. The second body of research deals with a new type of “arazzo” (removable and usable seasonally) to improve the insulation of the walls. The study case regards the collection of historic “arazzi” in Sala della Balla, in Castello Sforzesco as well.

The focus is to investigate how the main properties of the removable devices affect the thermal exchange with the air and the surfaces where they are applied. A third study case is a masterpiece of listed modern architecture, Casa del Fascio in Como, where the new uses require cooling with the addition of a shadowing system.

Keywords – removable devices, historical buildings, energy efficiency, conservation

1. INTRODUCTION

The use of removable devices and systems is not common for mitigating environmental impact on buildings at present. Nevertheless in the past, removable systems were used for improving comfort: expensive and precious tapestries, curtains (inside windows, along porches and loggias), and double window frames that included rolling shutters between the frames. The devices, tools and systems require proper management and maintenance, they differ and their thermal behaviour is hard to model because the calculation of the improvement in performance is still approximate. On the other hand, they have the advantage of constituting additional and complementary protection with the existing vertical closures, improving the performance and thermal properties of traditional materials and building techniques. Moreover, they are removable, reversible, compatible with the existing buildings and not necessarily expensive. Hence, they meet the conservation requirements. In some cases, at temperate climate, their contribution is higher than contemporary insulation inside the rooms: in fact, the latter causes an increase of temperature inside the buildings in the hot seasons, therefore the seasonal removability in case of a new system constitutes a great advantage.

For these reasons, the appreciation of removable devices has been increasing in scientific literature in the last years (not in the professional practice yet), especially with regard to shadowing systems and solar screens. In Italy since

2006, the legal framework created significant tax reductions for their application. Since 2009, shading systems are compulsory in the refurbishment of existing buildings¹ 2009 was, in fact, the year in which the question of summer air conditioning use was set inside legislation, thus explaining the introduction of shading. In reality, the use of mobile devices, as will be seen in the following, are useful both for the cold and the hot season, as well as for controlling the infiltration of air from the windows. The replacement of glass with higher performance materials is not always the best solution given the need not to decrease winter heat accumulation while dampening the flow of heat entering during the summer (what was done in the past, for example, in the “barchessa” in the Venetian villa, the pergola with deciduous vegetation).

The theme is also reflected in the Guidelines that the Ministry of Cultural Heritage has issued for the improvement of the energy efficiency of cultural heritage (2015), which also deals with strategies for cooling.

Our experimentation, obtained with different and combined diagnostic and simulation methods, intends to demonstrate their effectiveness also from a quantitative point of view, and even if currently applied to very important case studies and therefore to listed buildings, it should be possible to extend the devices also for the improvement of any class of buildings not necessarily subject to protection.

2. STUDY CASES

The first study case is Sala delle Asse at Sforza Castle, in Milan [1]. Over recent years, a consistent phase of study went on for planning the most effective restoration intervention of Leonardo paintings and monochromes. The analysis and microclimatic monitoring of the last 8 years resulted in diagnostic of some causes of thermal/humidity imbalances inside the room, despite of the lack of heating/cooling [2].

Due to the damage (especially salt diffusion, which is still spreading) [3] on the precious decoration, the authors' assignment was to study and prototype a system to mitigate the air flux entering through openings, especially the northwestern window. In fact, the protection by law of any existing feature/part of the buildings prevented the substitution of the window frames in the castle. This is the reason why the authors developed an innovative kind of internal screen, following a challenging set of requirements:

- the minimization of the fixing points of the frame to the historical walls of the castle;
- the UV and fire protection of the textile membrane;
- the reduction of the air flows from the window through the screen;
- the full size of the 4x6 m screen on one hand, and the easy removability and wash-ability on the other.

1 The designer assesses and evaluates the effectiveness of the glass screen for reducing the energy request due to the air-conditioning plants (DPR 59/09 art. 4 comma 18 a).

The optical, thermal and mechanical behaviour of six different kinds of knitted textiles were compared and three options of installation procedures were evaluated. Eventually a full size, double curved, textile screen, supported by an ultra-lightweight FRP bending active thin frame would be tested, with the final aim of measuring, on site, the daytime lighting and breath-proof quality of the final screen.

With the aim of optimizing the prototype project, especially its performances of reducing the warm air draughts in summer, the authors simulated the location of the curtain by Ansys software. Computational Fluid Dynamics (CFD) is, in fact, a useful tool for the evaluation of the microclimatic conditions in cultural heritage [4]. A thermo-fluid-dynamic was used for the verification and validation of the project hypothesis. The numerical analysis allows the researchers to define devices with low energy consumption and compatible with the restrictions that protected historical buildings require. The fundamental aspect of CFD is meshing the fluid continuous medium and the possibility of affording complex 3D geometries and physical environmental phenomena at different scales.

At the Sforza Castle, ANSYS Fluent software was used to model the space inside the room, for studying the best location of the curtain to insert for improving the north western window frame tightness and mitigating the thermal dispersion. Four simulations resulted: the graphic output is through plans, sections, and graphs.

Their comparison shows that solution 1 is the best fit (the curtain is at the inner side of the window). In fact, the plan in Figure 1 shows the wider distribution of externally created heating flux (3 m^2), whilst Figure 2 shows a sharp reduction of the heating flux (less than 1 m^2) close to the window if the curtain is set very close to the interior window frame. The improvement in terms of energy efficiency is appreciable for preventing the extension of air mass, showing the temperature variation. Nevertheless, due to the kind of the modeled fabric (large amounts of voids) the presence of the curtain does not substantially reduce the thermal variation due to the heating flux (in the worst case, it is almost 3.5 C° in August, at 7 pm).

Another type of research carried out in Castello Sforzesco was to test the traditional devices for improving temperature comfort inside the buildings: one of the rooms in the museum hosts 12 historic, precious tapestries dating back to 1510, hanging on their horizontal support, at few centimetres from the wall. The large room has three sides almost completely covered with the tapestries, two of these sides are external.

The thermal properties of the tapestries has been investigated through active IR Thermography (10 minutes of heating by irradiation of a halogen lamp), and passive and surface temperature measurement by contact probes. As shown in the temperature graph (Figure 3), the surface temperature is much higher on the side under direct irradiation than on the side towards the wall. In fact, the increase of temperature of this second side is only about $0,5 \text{ }^\circ\text{C}$. Moreover, on this rear side, the increase of the temperature started 8 minutes after the beginning of the heating. Therefore, the tapestry behaves as insulating material: it has a high

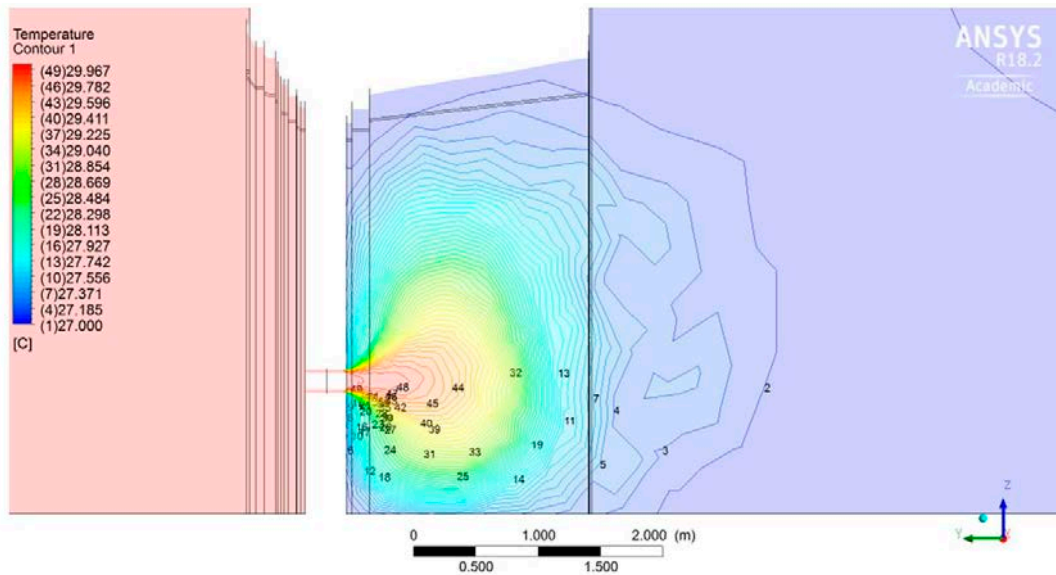
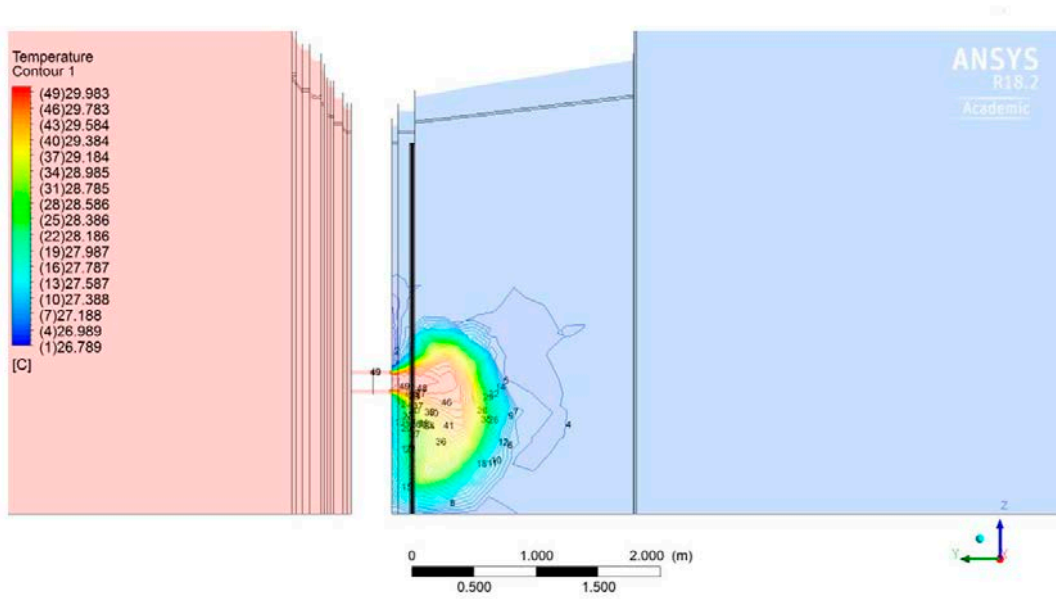

Figures 1 and 2. 3D model of the NO window (conceptual and wireframe), above with the curtain close to the window, below without the curtain.

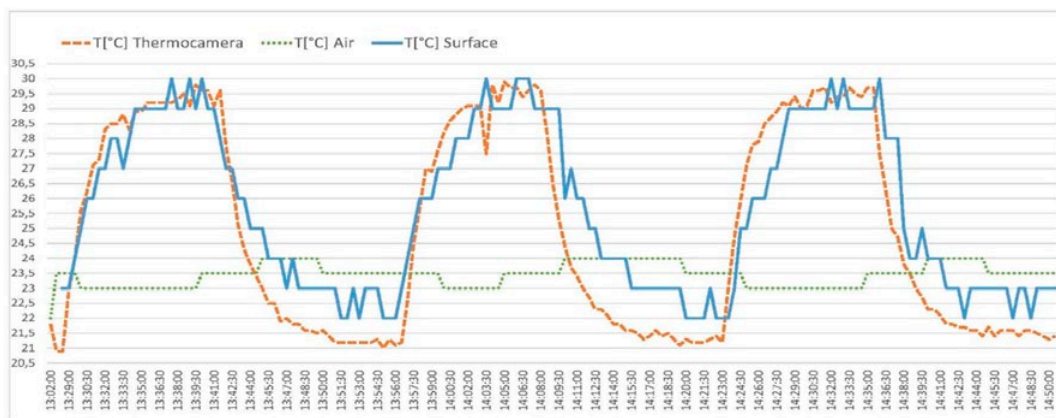

Figure 3. Graphic of the temperatures during three heating/cooling phases: the temperature of the tapestry surface, red line (by IRT), blue line (by contact probe); temperature of the side of the tapestry toward the wall and air trapped in the tapestry knots, green line (by data-logger).

increase of temperature under irradiation, but it does not transmit it. At last, the graph shows, the procedure of measurements is also reliable, because the obtained results are almost the same, assuring the repeatability of the measures.

Another study, with the aim of comparing the efficacy of a removable solution, based on a textile system, with a more traditional one, such as an internal insulation, has been developed creating a multi-layered insulating textile-based kit. The innovative wallpaper kit has a finishing textile layer and an insulating one, which are completely independent, combining properties of advanced technical textiles and high performance insulating materials in few millimetres of thickness. The new prototypes² were installed inside the building “La Nave” in the Leonardo campus, Politecnico di Milano, designed by Gio Ponti, a famous architect active from the nineteen-twenties to the seventies, and built in 1965. It is typical of the massive constructions of the period with low levels of thermal insulation. The thermal performances of the new textile wallpaper were measured and compared to two more traditional internal thermal insulation systems (wet assembled, thicker than the new textile wallpaper, not reversible) (Figure 4).

The results of the tests are interesting, because the performances of the bilayer textile and aerogel are comparable with the one of the interior traditional insulation. In addition, the new wallpaper is suitable for application on historic buildings; therefore, a further step of the research includes the technical design of a removable, flexible, adaptable support that does not require permanent anchorages [5].

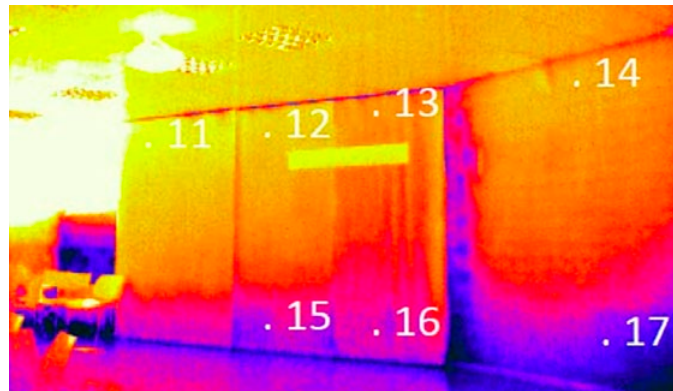

Figure 4. RT thermogram of the three materials applied on the surface and inside the dead space of the cavity masonry (perlite). Range of temperatures 17.5–21.5 °C. Numbers 11–17 locate the small areas where the researchers calculated the minimum, average, maximum temperatures.

- 2 For the experiment, the authors selected a coated and 2-layer laminate (bi-laminate) textile. Characteristics of the textile used in the experiment are: Self-supporting & finishing a) Textile Brand name TO-OPT-072, weighting 146±6 g/m², Bi-laminate – white composition of 100 % polyester + 100 % PTFE membrane, Laminated-waterproof-vapour-permeable. The thermal behaviour of the insulating layer is: average water vapor resistance: Ret = 39.04 m²Pa/W; average thermal resistance Rct = 0.125 m²K/W; lambda-value = 0.036 W/mK. The choice of the textiles manufactured by Polish textile manufacturer Optex S.A. depended on its availability on the market, price and the aesthetic requirement.

Another research line focuses on solar screens. The Department for Cultural Heritage promoted this study on “Casa del Fascio” in Como (Figure 5). The building is one of the masterpieces of the Italian Modern Movement. In 1936 Giuseppe Terragni accomplished it. At present, it is an administration headquarter and in the near future it will become a museum. The building technique is experimental and light; furthermore, the percentage of the transparent envelope is high, therefore its use is not comfortable during the cold and hot seasons. In the first phase, the authors monitored the microclimate variables (RH and T °C) for 18 months by 6 data loggers.



Figure 5. Old photo of the main façade on Piazza del Popolo, with the original green roller curtain system.

Despite the heating system being on, the air temperature inside the rooms in winter seldom reached 20 °C; during the summer, monitoring recorded very high temperatures, very close to the exterior ones due to the low thermal inertia of the envelope. In addition, inside, the poor ventilation decreases comfort, already inadequate for human presence. On the basis of the monitored data and building characteristics, an energy simulation at dynamic condition (Energy plus software) was carried out, considering 31 climatic zones. The results of experimental data validated the model. Following this, the model simulated the effects of different design solutions³ between June and September (Figure 6). According to Terragni's original solutions, no longer in use,⁴ the addition of high performance curtains and shadowing systems to the exterior side of the envelope in

3 In addition to the restoration of the blinds (already existing, but in poor condition) and the restoration of windows, the introduction of curtains with the 'Soltis 92' fabric for the façade and 'Tempotest Star FR' for the internal shaft was simulated.

4 Terragni provided protection systems through external curtains on the façade, where there is the maximum summer radiation, in correspondence with the iron window frames along the shaft walls that surround the atrium and along the façade on the northwest side, corresponding to Via Pessina.

the courtyard can help [6]. The comparison of different materials and systems for shadowing was based on protection from solar irradiation, natural lighting, visual permeability, privacy, natural ventilation, thickness, weight, fire and wind proof characteristics.⁵

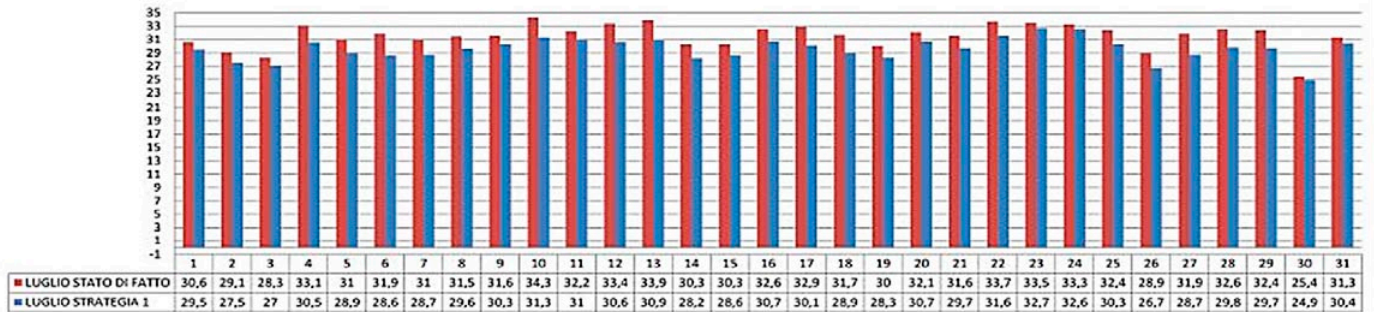

Figure 6. Explanatory diagram of the lowering of the monthly internal average temperature caused by the adoption of a shadowing strategy in July (blue column) compared to the actual situation (red column).

3. CONCLUSIONS

Learning from the past, the authors are trying to better understand how to obtain devices improving the energy efficiency of ancient buildings and, consequently, user comfort, where it is often impossible to adopt standard interventions. The goal is balancing the different needs of conservation and energy efficiency [7].

The current study cases show different solutions of great interest, perfectly fitting the goal. In Castello Sforzesco and La Nave, tapestry installation allowed to qualitatively evaluate that the tapestry behaviour differs from the contemporary textile. During the heating and cooling phases, the tapestry showed the characteristics of good insulating materials that firstly, reduce the contribution of conduction, despite the properties of the new textile in La Nave, that fast reach and hold the temperature of the air. In the Casa del Fascio, the added protection decreases the average monthly temperature up to 3 °C in the eastern-western zones. On the other sides of the building, the decrease is lower, around 1,5 °C and 2 °C from June to September, due to different solar ray inclination.

The next research step will focus on three aspects:

- 1) a complete characterization of the historic textile, used for tapestry and textile coating of the interior sides of walls, with the aim of reproducing similar optimal thermal behaviour with high tech textiles, reducing the costs, the thickness, weight, and improving the performance;

⁵ Different materials were considered, analyzing their radiative optical properties and performances related to the type of shielding, the geometry and the positioning. Families of products belonging to nets or canvas (metallic or plastic), bidirectional or three-dimensional metal sheet (pressed or perforated element), technical textiles and filters were examined. A survey was then carried out on fabrics already on the market that can be divided into three types: with spreading behaviour, coated or spread. For the façade: Tempotest star screen of Parà; Super-screen, Superscreen metal and Vertigo of Silent Gliss Italia; Screen g2 metal of Mottura, Soltis 86 and Soltis 92 of Serge Ferrari were considered. For the internal shaft: Tempotest, Tempotest star light, Tempotest star FR. A schedule was compiled for each to allow for comparison.

- 2) modelling the behaviour of historic and modern prototypes to evaluate the improvement;
- 3) designing the support of the modern textiles, according to the requirements of conservation (reversibility, non-invasivity, least impact on the existing structures, etc).

The authors also evaluated other solutions not presented in this paper, because of their limited contribution and the necessity of high scale building modification.

4 ACKNOWLEDGEMENTS

The authors thanks eng. Francesca Andrulli and Chiara Bonaiti for the simulations and analysis of results of the Sala delle Asse case and prof. Tiziana Poli for the laboratory characterization of glass and materials in Sala delle Asse.

5. REFERENCES

- [1] Tasso F., Palazzo M., *La sala delle Asse del Castello Sforzesco*. Leonardo da Vinci, Silvana ed., 2017.
- [2] Sansonetti A., Rosina E., Proietti N., Capitani D., Di Tullio V., Priori S., Rimini C. "MODihMAat Sforza Castle in Milano: Innovative Techniques for MOistureDetection in HistoricalMasonry", in *Built Heritage: Monitoring Conservation Management*, edited by Toniolo L., Boriani M., Guidi G., Springer International Publishing switzerland, 2015, pp. 187–197.
- [3] Rosina E., Sansonetti A., Erba S. "Focus on soluble salts transport phenomena: The study cases of Leonardo mural paintings at Sala delle Asse (Milan)", *Construction and Building Materials*, Volume 136, 1, 2017, pp. 643–652.
- [4] Balocco C., Grazzini G. "Numerical simulation of ancient natural ventilation system of historical buildings. A case study in Palermo", *Journal of Cultural Heritage*, volume 10, issue 2, april-june 2009, pp. 313–318.
- [5] Pracchi V., Rosina E., L'Erario A., Monticelli C., Aliprandi S., Zanelli A., "From arazzo to textile based innovative system for energy efficiency of listed buildings", in *Conference Proceedings of the 3rd International Conference on Preservation, Maintenance and Rehabilitation of Historical Buildings and Structures Heritage 2017*, ed by R. Amoeda, S. Lira, C. Pinheiro, Green Lines Institute for Sustainable Development Braga, Portugal, 14–16 giugno 2017, pp. 1093–1103.
- [6] Poli T., Mainini A. G., Paolini R., Speroni A., Vercesi L., Zinzi M. "Sviluppo di materiali e tecnologie per la riduzione degli effetti della radiazione solare. a. implementazione delle prestazioni e nuovi prodotti per il controllo della radiazione solare e costruzione di un archivio cartaceo di prodotti innovativi", ENEA Research, Milano, 2013.
- [7] Monticelli C., Zanelli A., Aliprandi S., Pracchi V. N., Rosina E. "The energy efficiency improvement of listed buildings through textile-based innovative system", in: *Advanced Building Skins*, Berna, Switzerland, October 10–11 2016, pp. 192–202.

The “Waaghaus” of Bolzano

Energy efficiency, hygrothermal risk and ventilation strategy evaluation for a heritage building

D. Exner, M. Larcher, A. Belleri, A. Troi and F. Haas

Institute of Renewable Energy, EURAC Research, Bolzano/Bozen, Italy. Email: dagmar.exner@eurac.edu, marco.larcher@eurac.edu, annamaria.belleri@eurac.edu, alexandra.troi@eurac.edu, franziska.haas@eurac.edu

Abstract – The present paper analyzes the renovation project of a heritage medieval building located in the city center of Bolzano—the “Waaghaus”. The building has been used as case study in the EU-project 3encult, where it has been extensively studied both from heritage and energy efficiency points of view. Our analysis, partly based on the experience gained in the EU-project, aims at validating and improving the renovation project that was developed by a design team commissioned by the owner. In particular three aspects of the renovation are mainly investigated: 1) Reduction of the energy demand 2) Indoor climate and air quality 3) Hygrothermal risk in critical points. Results show that the proposed renovation cuts the energy demand to 60 percent. Moreover they demonstrate that, when renovating a historic building, it is crucial to carefully investigate the ventilation strategy and the critical construction details. Not considering these two aspects can lead to poor air quality and to a significant risk of surface mould and condensation formation.

Keywords – historic building, energy retrofit, natural & active overflow ventilation, thermal bridge evaluation, hygrothermal risk evaluation, from research to practice

1. INTRODUCTION

The “Waaghaus” is an extraordinary medieval monument in the centre of Bolzano, Italy. Its refurbishment has to consider heritage and environmental aspects. The distinctive urban location, the rich extensive presence of historic plaster and wall paintings both indoors and outdoors, and the building structure developed over different periods, requires thereby a highly sensitive treatment of the building. The building already served from 2010 to 2014 as a case study in the FP7 EU-Project 3encult “Efficient Energy for EU Cultural Heritage”. Comprehensive historical study, urban analysis, energetic calculations, and hygrothermal monitoring, as well as the development of new technical solutions, allowed the interdisciplinary research group to propose a renovation project mainly based on passive architectural solutions. This would have reduced the energy demand of the building by 56 percent while respecting the rich heritage value [1].

In 2017 a design team developed new plans for the transformation of the Waaghaus in a centre for cultural associations, including meeting spaces and café. Achieving a sensible restoration that was compatible with the conservation of the heritage value of the building limited the extent to which the energy

performance was improved. Although the refurbishment still aims at meeting the criteria of the ClimaHouse R certification [2], the energy interventions developed in 3encult had to be adjusted to the new design, user requirements and financial resources. As a result, the ventilation system was planned only for the ground floor and attic, but not anymore for the two middle floors, due to the absence of space for ventilation ducts. Coupled with the existing poor thermal quality of the exterior walls, this can have three main consequences: Firstly, it will result in a higher energy demand. Secondly, uncontrolled ventilation rates might lead to increased internal humidity and CO₂ levels and thirdly, uninsulated components will cause low surface temperatures – both aspects could lead to significant hygrothermal risk increase.

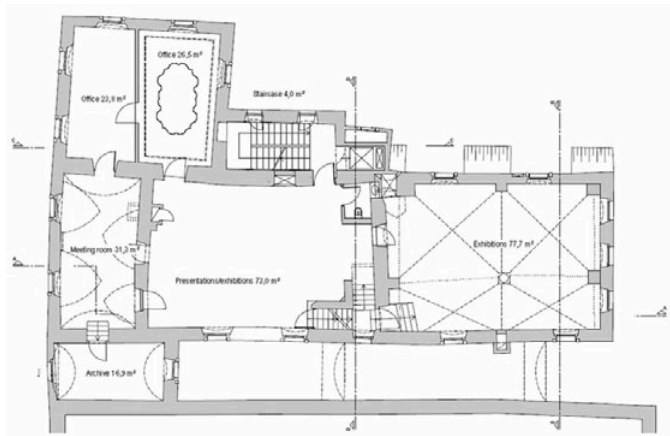

- Date of construction: Romanesque origins
- Heated net floor area: 878,7 m²
- Heated gross floor area: 1.178 m²
- Heated gross volume: 4.776 m³
- S/V ratio: 0,41
- HDD: 2791 (HDD)

Figure 1. Medieval Waaghaus in Bozen/Italy (© EURAC); 1st floor plan. © Architekten Piller Scartezzini).

Therefore, to prevent building damage and guarantee adequate comfort levels, it was necessary to carefully analyse the ventilation strategy and evaluate its impact on the internal climate. Moreover, all the single construction details were analysed and accordingly improved in order to verify the compatibility with the expected internal climate from a hygrothermal point of view. This paper will analyse the consequences of the new renovation project on three crucial aspects of the building, namely 1. Energy demand, 2. Indoor climate and air quality, 3. Hygrothermal risk in critical points.

2. METHODOLOGY

2.1 RETROFIT SOLUTIONS AND ENERGY BALANCE

The energy demand was evaluated for the existing building and for the renovation project, using PHPP (Passive House Planning Package) [3].

2.2 STUDY OF INDOOR AIR QUALITY

As the 1st and 2nd floor cannot be ventilated with a traditional mechanical ventilation system, the design team proposed a natural ventilation approach. In the present paper we evaluate three ventilation strategies with the multi-zone air flow and contaminant transport analysis software CONTAM [4]. Two strategies follow the natural ventilation approach proposed by the designers, while a third strategy introduces a ductless ventilation system [5]:

- natural ventilation with windows operated three times a day (morning 15 min. windows open, windows tilted 45 min. during lunch break, late afternoon 15 min. windows open);
- natural ventilation with windows tilted once a day 45 min. during lunch break;
- active overflow ventilation [5] with 1500 m³/hr supplied in the central hall next to the staircase on 1st floor and extracted at the end of the corridor at 2nd floor.

Main aim of these simulations is to investigate indoor relative humidity levels and air quality regarding CO₂ concentrations. Rooms' occupancy rates are defined according to the national standard UNI 10339:2005 [6], with e.g. 0.12 pers/m² in office rooms and 0.7 pers/m² in exhibition area. The schedule foresees typical working days in office rooms, while exhibition areas are assumed to be used from Monday to Saturday from 10 to 18. Occupants are assumed to generate 38 g/h of CO₂ and 55 g/h of water vapour. Outdoor CO₂ concentration is set to 320 ppm (CONTAM default value). The leakage area is distributed uniformly along the envelope in order to have 1.5 ach of infiltration under pressurization test at 50 Pa. The window opening is modelled through a two-way model for single opening, while leakages through the "powerlaw" model.

2.3 STUDY OF THE HYGROTHERMAL RISK AT CRITICAL POINTS

The study of critical construction details is performed with the thermal bridges software Mold- and FrameSimulator [7]. The analysis is done according to the Italian national standard UNI EN ISO 13788:2013 [8]. It considers a thermal calculation with stationary boundary conditions and follows two different calculation procedures for opaque components with high thermal mass and transparent components with low thermal mass, as reported in Table 1.

Table 1. Calculation method and boundary conditions of mould and condensation risk calculation

Component type	Calculation method	Internal surface heat transfer resistance	External surface heat transfer resistance	Critical RH on internal surface for hygrothermal risk	Internal temperature
opaque	monthly	0.25 m ² K/W	0.04 m ² K/W	80%	20°C
transparent	daily	0.13 m ² K/W	0.04 m ² K/W	100%	20°C
frame corners		0.2 m ² K/W*			

* according to UNI EN ISO 10077-2:2012 [9] (reduced convection and radiation at frame corners)

The thermal quality of every construction detail is characterized by the temperature factor $f_{Rsi} = \frac{\theta_{si} - \theta_e}{\theta_i - \theta_e}$ [8], where θ_{si} is the lowest simulated surface temperature for the construction detail, while θ_e is the external ambient temperature and θ_i the internal room temperature. We then verify that the simulated temperature factor is larger than the critical temperature factor $f_{Rsi} > f_{Rsi, crit}$ which is the temperature factor that would lead to a critical hygrothermal behaviour. In our case, the critical temperature factor is calculated for the most critical day or month of the year, which means it is defined as the largest of all temperature factors computed on a daily or monthly basis. The critical temperature factor strongly depends on the interior climate of the building. Several specific assumptions for the interior climate will therefore result in several values for $f_{Rsi, crit}$. Considering the interior climate prescribed by the CasaClima R certification (1), the one of the Italian national appendix of the standard (2) and the results of the CONTAM simulations with the three ventilation strategies described above (3a, 3b, 3c), different critical temperature factors $f_{Rsi, crit}$ are obtained and compared. In particular for the national standard we show $f_{Rsi, crit}$ for two different moisture classes [8]: moisture class 2, “dwellings with mechanical ventilation, offices and shops” and moisture class 3 “dwellings without mechanical ventilation or buildings with unknown occupancy”. From the CONTAM simulation we obtain different internal climates for each single room of the building. We calculate $f_{Rsi, crit}$ for the average interior climate conditions (average) as well as the one for the most critical room (maximum).

3. RESULTS AND DISCUSSION

3.1 RETROFIT SOLUTIONS AND ENERGY BALANCE

Window replacement: The major part of the historic windows were replaced by box-type windows in the 1950s/60s – which actually do not have any historic or architectural value from a conservation point of view [10]. In the actual renovation project, they should be replaced, matching the heritage requirements in terms of the proportions, design of profiles and dimensions, by using a simple wooden frame with double glazing.

Table 2. Energy related parameters of the existing window and the retrofit option

Window types	U-value glazing U _g [W/m ² K]	U-value frame U _f [W/m ² K]	g-value glazing
Existing box-type	2.8	2.5	0.77
Retrofit project	1.1	1.55	0.64

Insulation of opaque components of the thermal envelope: Base on the comprehensive study of the historic value of the single building elements, a renovation concept was proposed, improving energy performance while maintaining the architectural and aesthetic value of the building. As described above, no intervention on the opaque part of the façade is possible for conservation reasons, thus heritage compatible energy interventions concentrate on other parts of the thermal envelope [1]:

Table 3. Enhancement of other envelope parts

	Roof	Baseplate to ground	Basement ceiling	Slabs toward arcades
Existing construction	Partly 8 cm of rock wool	Concrete slab	Vaulted natural stone ceiling. lime mortar joints	Wooden beams; sand & pebble filling; underside ceiling lime plastered. floor wooden substructure and boards
U-value [W/m ² K]	1.4 – 2.6	2.7	1.0	0.44
Renovation project	19 cm insulation (λ 0.042) 11–13 cm between rafters. 8 cm from below	10 cm PU-insulation (λ 0.03) and 10 cm of foam concrete (λ 0.12)	6 cm PU-insulation (λ 0.03) 4 cm foam concrete (λ 0.12). 10 cm perlite (λ 0.09) as levelling fill on the vault	19.5 cm compressed wood fibres (λ 0.038). Between beams substituting existing filling. additionally 1.5–2 cm footfall sound insulation
U-value [W/m ² K]	0.22	0.20	0.22	0.21

Ventilation: For conservation reasons, the retrofit project foresees a traditional mechanical ventilation system with heat recovery only for the top and ground floor, while the necessary air change rates in the 1st and the 2nd floor should be provided with a ductless ventilation strategy. The simpler approach is the use of natural ventilation while a more advanced approach would be the use of an active overflow ventilation system, which avoids the usual invasive implementation of an air-duct distribution system, but still gives the possibility to have a heat exchanger which contributes to the reduction of the energy losses [5].

Heating demand comparison: The calculation of energy demand for the existing building and for the renovation project shows that the foreseen renovation measures lead to a decrease of energy demand of around 40 %, when considering the ventilation strategy of the renovation project with controlled ventilation system with heat recovery on ground and top floor and natural ventilation on 1st and 2nd floor, as well as with improved thermal bridges (like proposed in 3.3).

3.2 STUDY OF INDOOR AIR QUALITY

Indoor air quality simulations for the three cases show that only the continuous air exchange with active overflow ventilation (strategy “c”) can assure acceptable CO₂ levels during working hours, i.e. CO₂ concentrations at least within category III according to EN 15251:2008 [11], see Figure 2. Operating windows for three times a day (strategy “b”), can assure up to 65 % of the occupied time with acceptable CO₂ concentrations. Operating windows only one time a day (strategy “a”) leads to acceptable CO₂ levels for less than 25 % of the time.

Looking at the daily average values of relative humidity (Figure 3a), we can see that active overflow ventilation keeps the relative humidity under 40 % for most of the winter period (average 1st and 2nd floor winter period: 29.1 %). Slightly higher values are obtained when ventilating three times a day (average 1st and 2nd floor winter period: 32.8 %). Ventilating only once a day results in even higher humidity levels (average 1st and 2nd floor winter period: 41.5 %). This is mainly due to the

fact that excess humidity cannot be disposed at the end of the day and remains in the building overnight. Whether this is still acceptable from hygrothermal point of view is discussed in the next section (3.3).

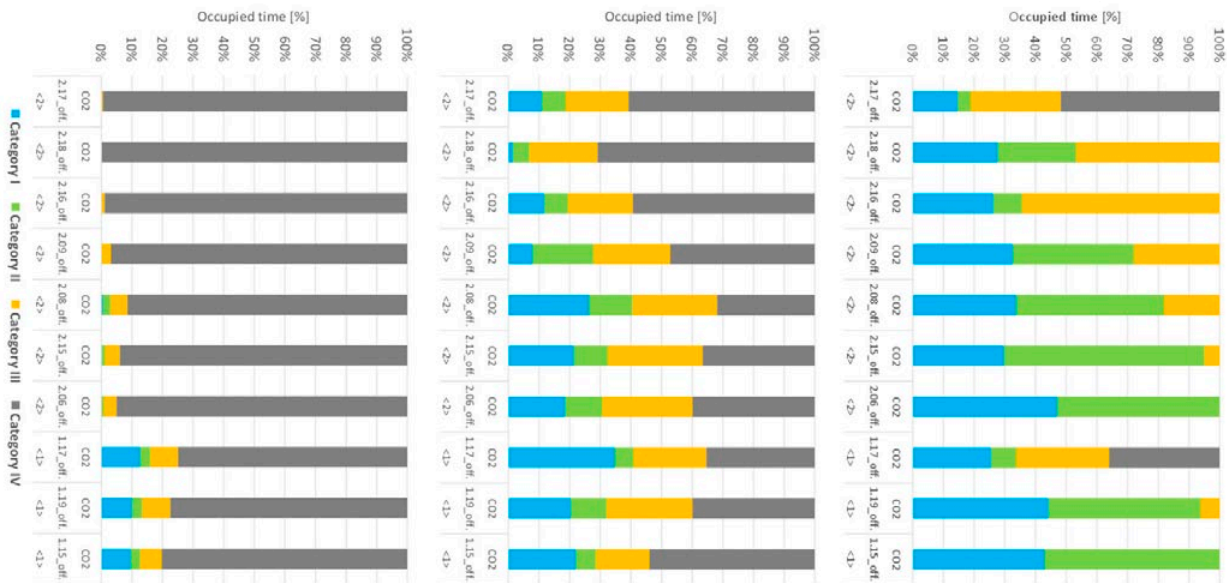

Figure 2. Percentage of occupied time when CO₂ levels are within Category I (CO₂ < 670 ppm), II (670 ≤ CO₂ < 820 ppm) and III (820 ≤ CO₂ < 1120 ppm) according to [10] in each office zone at 1st and 2nd floor for (a) natural ventilation one time/day, (b) natural ventilation three times/day and (c) active overflow ventilation.

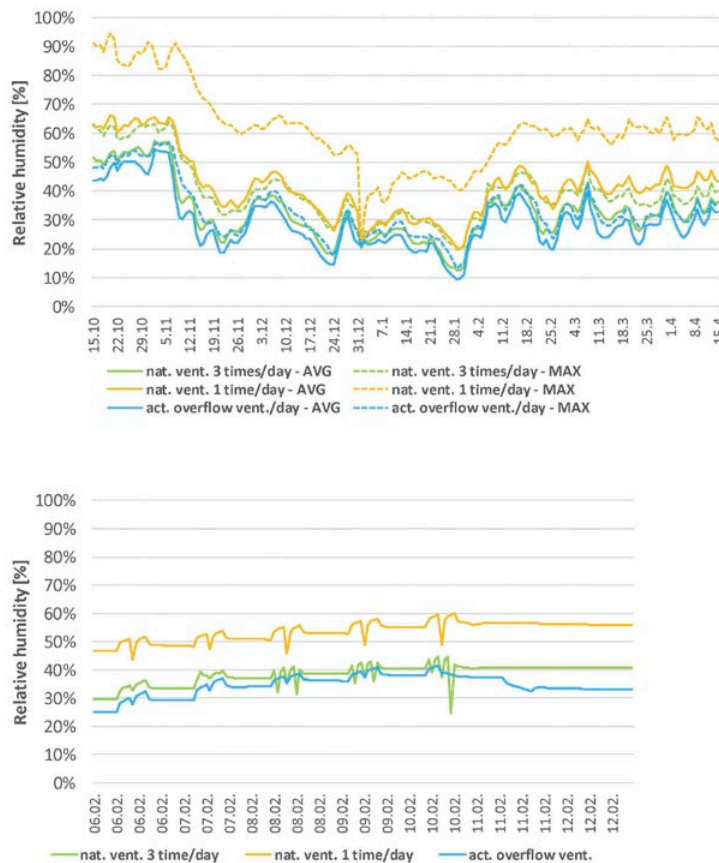

Figure 3. (a) Trend of daily average relative humidity [%] of 1st and 2nd floor (solid lines) and daily max. average of one room (dashed lines) for the winter period. (b) Trend of hourly average of 1 room for 1 week in February for the three simulation cases (natural vent. 3 or 1 times/day, active overflow vent.), © EURAC.

3.3 STUDY OF THE HYGROTHERMAL RISK AT CRITICAL POINTS

The results presented in Table 4 show that CasaClima R standard imposes a requirement which is on the safe side if the building is sufficiently ventilated. In fact $f_{Rsi, crit}$ for the CasaClima R certification is one of the highest of the table, the only exception are situations with poor ventilation, e.g. the CONTAM simulation with natural ventilation 1 time per day (3a), which lead to even more critical values.

Table 4. Critical temperature factor for the evaluation of the hygrothermal risks for different calculation methods and design variants. Connection details with a temperature factor lower than the one reported in the table will lead to mould growth or condensation. The critical temperature factors represent the (i) average value for the 1st and 2nd floors and (ii) the daily average of the room with the highest humidity



Calculation method	$f_{Rsi, crit}$ – mould growth monthly calculation, valid for opaque components		$f_{Rsi, crit}$ – condensation daily calculation, valid for transparent components	
	Class 2	Class 3	Class 2	Class 3
1) CasaClima R Certification	0.587			
	Class 2	Class 3	Class 2	Class 3
2) UNI EN ISO 13788, National Appendix	0.380	0.571	0.435	0.593
	<i>average</i>	<i>maximum</i>	<i>average</i>	<i>maximum</i>
3a) CONTAM, NatVent – 1 time per day	0.614	-	0.392	-
3b) CONTAM, NatVent – 3 times per day	0.271	0.552	0.094	0.357
3c) CONTAM, Active overflow	0.063	0.199	0.028	0.189

Since the aim is to certify the building according to the CasaClima R certification, we have been analysing all the connection details in order to fulfil the requirement imposed by this standard, i.e. $f_{Rsi} > f_{Rsi, crit} = 0.587$. This choice is on the safe side compared to the national standard and also to the CONTAM simulations – with the important prescription that the building has to be ventilated well, to avoid that excess humidity remains in the building overnight.

Opaque components connection details: In Table 5 we present the analysis of the most critical connection details, calculating the corresponding f_{Rsi} (i) without any further intervention and (ii) improving the thermal performance and thus increasing surface temperatures with a preferably heritage compatible solution. For most critical connection points of the exterior wall, we suggest to apply a layer of lime-based insulating plaster (λ 0.057 W/mK), which can follow the uneven historical wall surface. From the result presented in the table one can see that the proposed intervention is crucial in order to fulfill the CasaClima R requirement.

Window spacer detail: The thermal simulation of the bottom profile of the new proposed window results in a thermal bridge coefficient of the glazing edge, ψ_g of 0.063 W/mK and a condensation temperature factor, f_{Rsi} , of 0.583. The latter does not fulfil the requirements of the CasaClima R protocol. We therefore propose to increase the spacer's performance improving the originally foreseen stainless steel spacer (1) to a stainless steel spacer with optimized geometry (2)

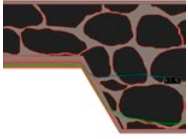
Table 5. Thermal bridge analysis – most critical connection details selection and corresponding f_{Rsi}

	Picture thermal simulation (optimized)	$f_{Rsi} (i)$ without any further intervention	Proposed intervention	$f_{Rsi} (i)$ with proposed intervention	Result
Horizontal connection parapet – exterior wall		0.477 (< 0.587)	+ min. 4 cm lime-based insulating plaster ($\lambda 0.057\text{W/mK}$) on parapet and wedge-shaped (from 2–0 cm) on the reveal	0.636 (> 0.587)	Requirements met. No condensation and mould growth risk*
Horizontal connection bay windows – exterior wall		0.356 (< 0.587)	+ min. 2 cm lime-based insulating plaster on inner surfaces of bay window; + 4 cm on the outermost wall ($\lambda 0.057\text{W/mK}$)	0.617 (> 0.587)	Requirements met. No condensation and mould growth risk*

*see mould isotherm in green/purple at 12.6°C; acc. to CasaClima certification criteria

Table 6. Analysis for glass spacer

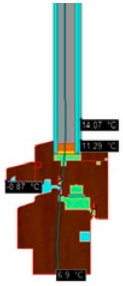
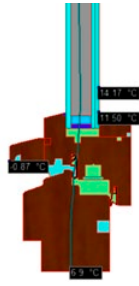
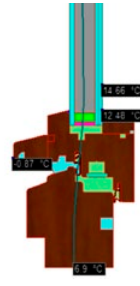
Glass spacer	Spacer 1	Spacer 2	Spacer 3
Thermal simulation with 3 different solutions			
Description	6.5 mm warm edge spacer of 0.18 mm stainless steel	7 mm warm edge spacer with 0.15 mm stainless steel with slots for light refraction	Reduced spacer height 6.9 mm; low heat loss: stainless steel 15.0 W/(mK). specialist plastic 0.17 W/(mK)
f_{Rsi}	0.583	0.593	0.640
ψ_g in W/m	0.063	0.060	0.0458

or to a hybrid spacer consisting of hard plastic and a fine stainless steel structure (3). As shown in Table 6 those spacers do not cause any hygrothermal risks and lead to an improved thermal performance.

Window-wall connection detail: Table 7 summarizes three design variants for the window-wall connection after the renovation intervention. It shows that replacing the window without any further intervention is not recommended from a hygrothermal point of view. We suggest, (i) to insulate the parapet and the reveals with a minimum of four cm of insulating plaster ($\lambda 0.057\text{ W/mK}$) and (ii) to add

flexible insulation in the potential cavity behind the existing plaster or below the window (where this appears when removing the old window). Furthermore, we recommend improving the airtightness at the window-blind wall connection and to reduce the insulation thickness of the insulating plaster gradually with a wedge-shaped structure to avoid hygrothermal risks at the transition point.

Table 7. Thermal bridge improvement (exemplary for the lateral window-wall-connection)

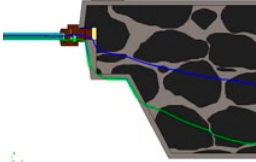
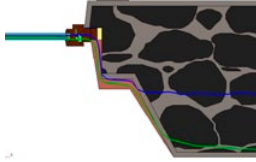
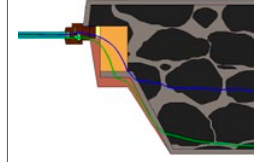
Connection detail	Horizontal lateral connection window-natural stone wall		
	Existing window-wall-connection	Improvement	Further improvement
Horizontal connection parapet – exterior wall			
Intervention	Window replacement only	+ 4 cm parapet insulation + 0-2 cm wedge on reveal	+ insulation in cavity next to the window
fR_{si}	0.447 (< 0.587)	0.688 (> 0.587)	0.688 (> 0.587)
Result	Requirements NOT met. Condensation & mould growth risk*	Requirements met. No condensation & mould growth risk*	Requirements met. No condensation & mould growth risk*

*see mould isotherm in green/purple at 12.6°C; acc. to CasaClima certification criteria

4. CONCLUSIONS

We have shown the importance of considering the correlation between energy interventions, ventilation strategies and the effect on hygrothermal risks, when renovating a historic building. It is crucial on the one hand to carefully investigate the critical construction details. On the other hand, it is necessary to do it simultaneously with the evaluation of the ventilation strategies. Not considering these two aspects can lead to poor air quality and to a significant risk of surface mould and condensation formation. The evaluation of the hygrothermal risk with an oversimplified approach based on national or certification standards might lead to wrong conclusions, especially in the case of non-residential buildings manually ventilated. Natural ventilation, if not operated properly, can lead to continued hygrothermal risks and poor indoor air quality in terms of CO₂ concentrations. It is therefore important to carefully design the ventilation strategy, even when relying on natural ventilation, and provide building users with precise instructions on window opening. Alternatively, it would be necessary to foresee mechanical solutions for window opening. An active overflow ventilation system reduces the hygrothermal risks, leads to better indoor air quality and contributes to the reduction of the overall building's energy demand. The final decision will therefore be made based on the weighting of the different options: a ventilation system or appropriate processes that ensure adequate natural ventilation.

5. ACKNOWLEDGMENTS

This paper is based on results from EU FP7 project 3ENCULT, Interreg Italy-Austria project LOW TECH and the work done within a support contract for the building owner. The implementation project has been worked out by “Architekten Piller Scartezzini”, Bolzano.

6. REFERENCES

- [1] Troi A., Bastian Z.: “Energy Efficiency Solutions for Historic Buildings – A Handbook,” Birkhäuser, 2014, pp. 222–237.
- [2] Agenzia per l’Energia Alto Adige – CasaClima, Agentur für Energie Südtirol – Klimahaus: “Technische Richtlinie Bestandsgebäude & Sanierung“, guidelines of an energy label especially for the retrofit of historic buildings, September 2017.
- [3] Passive House Planning Package (PHPP), energy balance and planning tool for efficient buildings and refurbishments, http://passivehouse.com/04_phpp/04_phpp.htm, April 2018
- [4] CONTAM, multizone indoor air quality and ventilation analysis computer program, <https://www.nist.gov/services-resources/software/contam>, April 2018
- [5] Troi A., Bastian Z.: “Energy Efficiency Solutions for Historic Buildings – A Handbook,” Birkhäuser, 2014, pp. 160.
- [6] UNI 10339: “Impianti aeraulici a fini di benessere”, 2005.
- [7] MOLD SIMULATOR/FRAME SIMULATOR, software for dynamic heat transfer analysis ISO13786, thermal admittance and time shift calculation, transient thermal bridges calculation, dynamic mould and condensation analysis, <https://www.dartwin.it/>, April 2018.
- [8] UNI EN ISO 13788: “Hygrothermal performance of building components and building elements – Internal surface temperature to avoid critical surface humidity and interstitial condensation – Calculation methods”, 2013.
- [9] UNI EN ISO 10077–2: “Thermal performance of windows, doors and shutters – Calculation of thermal transmittance – Part 2: Numerical method for frames”, 2012.
- [10] Franzen, C. et al: “D 7.6 Report on conservation compatibility of the developed solutions and methods”, 3Encult, February 2014, pp. 5–24.
- [11] EN 15251: “Indoor environmental input parameters for design and assessment of energy performance of buildings addressing indoor air quality, thermal environment, lighting and acoustics”, 2007.

3D spatial reconstruction and non-destructive energy diagnostics of building interiors with smart devices

C.D. Şahin and M.P. Mengüç

*Center for Energy Environment and Economy (CEEE), and Department of Mechanical Engineering
Ozyegin University, Istanbul, Turkey*

Abstract – Energy efficient retrofitting of historic buildings is crucial to pass on these buildings to the next generations. In the process, the implementation of destructive techniques should be avoided and substituted with non-destructive approaches to prevent the destruction of their heritage significance, especially when energy efficiency is of interest. Although, infrared thermography, a non-destructive technique, is relatively time-efficient, it is rather labour-intensive for practical energy diagnostics. This is true since 2D thermal images have low spatial resolution and require an effort to understand what is being shown in the thermal image. Hence, many 2D thermal images and raw image processing are required to assess the situation, which is also time-consuming to prepare. In this study, a new 3D-aware smartphone methodology was deployed with an integrated infrared camera to obtain the 3D spatial reconstruction and thermal mapping of building interiors. This approach is for facilitating retrofit decision making in historic buildings, and therefore, distinguishing and eliminating energy efficiency measures that are distorting the heritage value of buildings. Results show that the system is capable of accurately generating a 3D spatial model of a room space in approximately five minutes and the resolution is sufficient to carry on detailed energy diagnostics.

Keywords – 3D; spatial reconstruction; thermal mapping; smart devices, historic buildings

1. INTRODUCTION

Historic buildings are a significant part of human heritage. In order to carry their cultural heritage value to future generations, historic buildings should be well adapted to meet the societal and national targets, such as energy saving measures [1].

Energy saving measures in historic buildings require a special approach during decision making, since taking building conservation into consideration is necessary. For instance, adding insulation to external walls that have ornaments and plasterworks destroys the appearance and aesthetic value of these buildings. The practice should be avoided whenever possible. Therefore, determination of energy saving measures in historic buildings is indicated as a multidisciplinary elimination process that gives heritage value a priority in decision making [2].

The building envelope is responsible for considerable heat loss throughout the historic buildings. Yet at the same time, identification of the heat losses requires

an in-depth energy diagnostic, together with qualified labour workforce and time. The use of destructive techniques through energy diagnostics in historic buildings can be considered as a contradiction to conservation of heritage value, since it requires direct contact with the building. Instead, non-destructive techniques (NDTs) should be deployed.

Infrared thermography (IRT) has a prominent popularity among the NDTs, which enables non-contact, quick and accurate qualitative and quantitative investigation for building energy diagnostics. IRT has many applications in buildings such as thermal characterization of walls, thermal bridging and excessive heat-loss-area detection, thermal insulation examination, thermal characterisation of glazing and windows, U-value measurement, air leakage inspection, moisture and water detection, HVAC system characterization, electrical system characterization, indoor temperature measurements, and human comfort assessment [3]. However, thermal cameras have lower spatial resolution (160×120 or 320×240) when compared to their digital counterparts. Therefore, representation of the inspected building area with a thermal camera necessitates a considerable number of thermal images to be analysed, which is time-consuming [4]. Besides, paper-based energy audit reports involving thermal images complicate the understanding of what is being shown in the thermal images, even though they are given with their digital pairs. Therefore, 3D thermal mapping and scene reconstruction models have been developed to tackle the corresponding issue [5].

Several studies have recently focused on 3D scene reconstruction and thermal mapping techniques for this purpose. The general approach among those studies is to, first, obtain a 3D point cloud with a depth sensing camera or image-based approach [4, 6–7]. Afterwards, 3D thermal images or point clouds are superimposed into the 3D spatial point cloud providing that thermal camera is geometrically aligned with depth sensing camera.

A recent study focused on an image-based 3D reconstruction method, which includes Graphic Processing Unit-based Structure-from-Motion and Multi-View Stereo algorithm, for creation of a 3D geometrical point cloud. Geometrical alignment is provided with the estimation of relative pose of the thermal camera with respect to that of digital camera. Next, the 3D thermal point cloud model is generated using the intrinsic and extrinsic thermal camera parameters and dense reconstruction algorithm. Later, 3D thermal and spatial point cloud models are superimposed. However, this approach is timewasting and requires extensive computer processing and thus qualified labour workforce to generate the model [4]. Similarly, a couple of studies focused on generating 3D thermal mapping of building interiors with the help of laser scanning sensor and thermal camera. Apart from image-based 3D reconstructions of point clouds, the motivation of the studies was based on merging the images obtained from the laser scanning depth sensor and consumer-level thermal camera [6–7].

Another research study was conducted to obtain 3D indoor scene reconstruction with smart devices and used two different approaches. The first one basically relies on leveraging data from smartphone sensors, such as accelerometer,

gyroscope, magnetometer and camera to generate the model. The approach generates a 2D floor plan and corresponding 3D indoor scene model with a smartphone by capturing a panoramic image of a room with the help of user interaction to detect the position of room corners and doors while maintaining the Manhattan World Assumption. However, this approach lacks a 3D-aware sensing, and it limits the user to rotational motions only. Additionally, it is unable to generate accurate models without manual adjustments [8]. The second approach uses a 3D-aware smart device that can track 3D position and orientation in the space and estimate the depth points in a scene. Depth points are later turned into a point cloud and used in generating the computer aided design (CAD) model within the same device [8]. Although, the second algorithm appears to be more practical and accurate in terms of 3D CAD modelling, both approaches focus on 3D spatial reconstruction of building interiors without taking thermal sense into consideration.

In the present study, coupled smart devices, i.e., a smartphone and an integrated thermal camera, are deployed to generate 3D spatial reconstruction of a room and display the thermal images on where they were taken from. The smartphone, which is capable of sensing 3D position and orientation in the surroundings and estimate the feature points, is used to generate the 3D spatial reconstruction model. Following the capturing of the digital and thermal images, they are superimposed into the 3D model. This study is the first of its kind that uses smartphone and thermal camera in this manner.

2. METHODOLOGY

2.1 PROCESSES

The methodology followed throughout the study is demonstrated in Figure 1. Basically, it consists of four main processes, namely, calibration, programming a smartphone application, 3D spatial reconstruction, and thermal mapping.

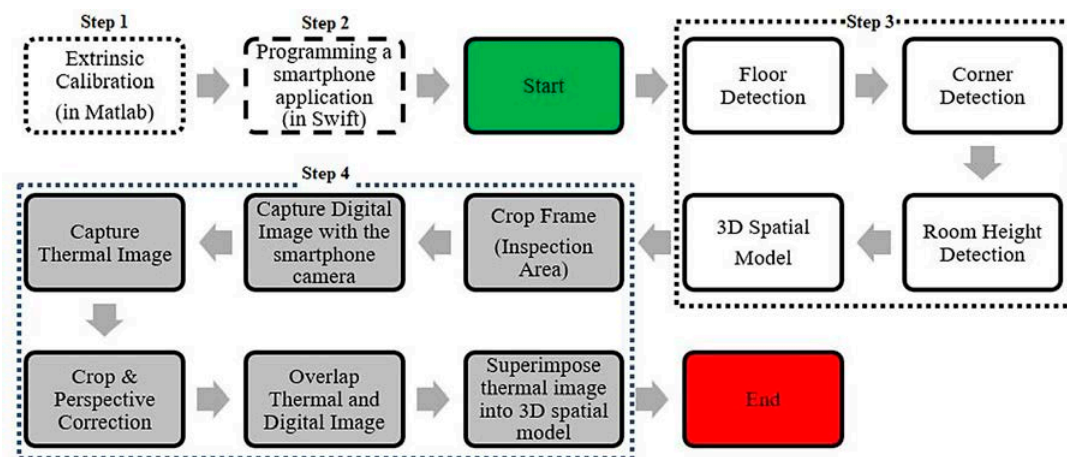

Figure 1. Flowchart of the current methodology.

First, extrinsic calibration between two smart devices are performed. Secondly, a smartphone application is programmed so as to collaboratively employ the smartphone and thermal camera capabilities. Afterwards, the 3D spatial model of the room is reconstructed by detecting floor, corners of the wall and the room height. Once crop frame of the audit area that is based on the image resolution of the thermal camera is located, thermal and digital images are captured and cropped according to the frame. Later, perspective correction is applied to the images to better illustrate the geometrical alignment. Finally, having done the perspective correction, images are superimposed to end the progress.

2.2 EXTRINSIC CALIBRATION

In order to integrate images taken from coupled smart devices having different sensing modalities, representing them in a common geometric reference frame is required. Therefore, extrinsic calibration, which is the determination of relative translation and rotation between different sensors, needs to be performed. Figure 2 shows the coupled measurement device system, of which the thermal camera, FLIR One Pro, is on the right side and integrated to the smartphone, iPhone 7 [9, 10].



Figure 2. The smartphone (left) and integrated thermal camera (right).

In this study, extrinsic calibration of thermal and digital cameras was executed according to the RGB cameras since FLIR One Pro has its own geometrical alignment algorithm between thermal and digital cameras, which is called Multi Spectral Dynamic Imaging (MSX) [9]. MSX basically incorporates thermal images enhanced with visible spectrum definition and produces a rich thermal image in detail. Therefore, it is not needed to perform extra extrinsic calibration between the digital camera of smartphone and thermal camera. A planar checkerboard is utilized to obtain intrinsic and extrinsic matrices in Matlab [11]. Then, geometric alignment between two devices is performed in a smartphone application.

2.3 SMARTPHONE APPLICATION

For this work, Swift programming language was used to write a smartphone application which helps users to conduct each step in the same device. An application interface was designed for users to easily understand the thermal and spatial data. In order to use the world tracking capabilities of the smartphone and sensor data from thermal camera, ARKit and software development kit (SDK) of the FLIR One Pro were used, respectively.

ARKit is a new SDK for making smart devices depth sensing and 3D-aware. Basically, it combines captured images and motion data from the device in order to do tracking. Therefore, the smartphone can provide world tracking which includes orientation and relative position of the device. With the help of captured scene images and world tracking information, feature points can be produced and users can understand their position in space, hence experience Augmented Reality (AR) via advanced scene processing and display conveniences [12].

FLIR One Pro has its own SDK that was initially designed to be programmed in Objective-C. At the same time, the code written in Objective-C language can also be operated within Swift provided by their interoperability [9]. Therefore, thermal data obtained from FLIR One Pro can be manipulated as desired.

2.4 3D SPATIAL RECONSTRUCTION

Traditional methods require users to measure the room geometry and later manually construct the room spatially in CAD environment, which is laborious. Besides, 3D spatial information obtained with the help of light detection and ranging (LIDAR) systems, entails a high number of measurements including furniture and other occlusions, which also need to be removed to obtain room geometry. However, the methodology used in this study employs the 3D sensing capabilities of a smartphone to capture 3D indoor spatial information. It takes approximately three minutes to reconstruct the room spatially in the same device. Since the aim of this study deals with the building envelope, reconstruction of furniture and other objects are out of scope.

In the current approach, first, the floor is detected by the embedded algorithm inside the ARKit, which is based on combining the 3D feature points at the same

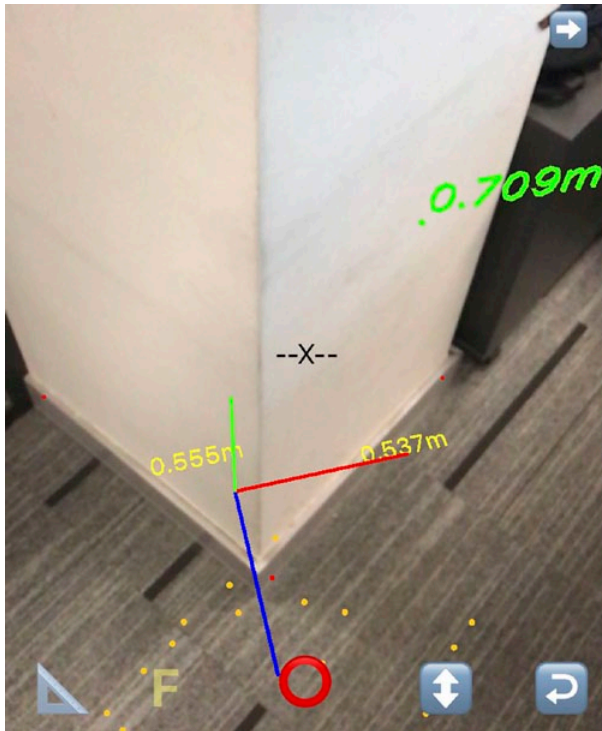

level that are perpendicular to the gravity. Secondly, the corners are detected with the hit-testing which involves sending a ray from the device and intersecting it with the floor that already has been detected. In this way, the positions of the corners can be detected in 3D environment and the distance between each corner can be calculated. After capturing the corners of the room and turning into the starting point,

Figure 3. 3D spatial reconstruction process and of measured parameters.

the room height is obtained with the help of a vertical plane detection algorithm of the ARKit, which similarly detects and combines the 3D feature points that are parallel to the gravity. Once the room height is captured with hit-testing and calculated, 3D spatial reconstruction of the room is conducted within the same device. The 3D spatial reconstruction process, which includes feature points, floor detection, corners and an arbitrary height and wall length, is shown in Figure 3.

The intersection of red, green and blue lines represents the origin of the location where the camera recordings are initiated. The red, yellow and green points illustrate corners, feature points and an arbitrary height while the yellow and green texts show the length between consecutive red points and room height, respectively. The cross sign in the middle of the screen is an indicator of the location where hit-testing will take place while detecting the corners and height.

2.5 3D SPATIO THERMAL MODEL

In this section, the mapping process of the thermal image on the corresponding location of the 3D spatial model, will be given. Having reconstructed the 3D spatial model of the room, the crop frame of inspection area is drawn based on the image resolution of the thermal camera and the images are captured. Since the thermal camera is fixed to the smartphone, and they are geometrically aligned, first, perspective correction is applied to the images. Later, the images are translated and superimposed into the corresponding crop area of the 3D spatial model that has been detected in the earlier process. Translation is performed with embedded code during programming provided by the world tracking information obtained from the smartphone. The reason of applying perspective correction to the images is that the thermal images are taken with an angle of tilt, between 5° and 50°, to the wall in order to avoid any reflection of the thermographer on the object. Finally, the geometrical difference that can be occurred due to perspective distortion is minimised and the thermal image is ready to be superimposed onto the 3D spatial model within the same device.

3. RESULTS AND DISCUSSIONS

The results of this study are given in Figure 4, which consists of overlapped thermal and digital images on the left and 3D spatio-thermal model on the right. The case study was conducted in the corridor of an apartment flat, of which indoor temperature is at least 10 °C higher than outdoor. Total time to generate the results of the 3D spatio-thermal model of the corridor and overlapped images in the same device, lasted approximately five minutes. The proposed method also points out that the quality of interpretation of infrared images can be improved by localising the diagnostics on building envelopes and visualising the results in 3D spatial model as well as corresponding geometric information.

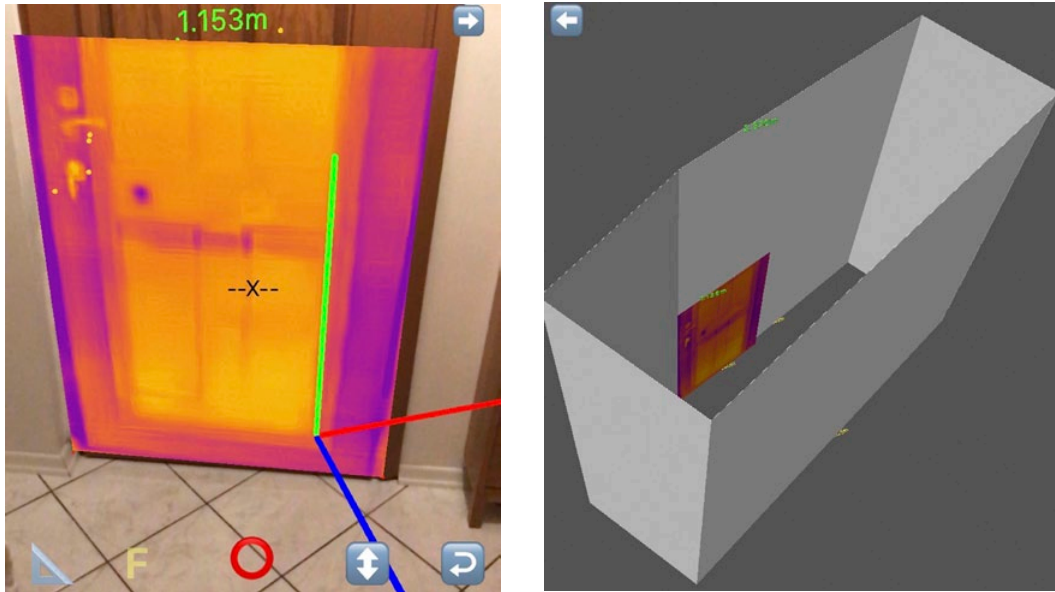

Figure 4. Overlapped images (left), 3D spatio-thermal model and calculated measurements (right).

The figure on the left illustrates the cropped infrared and digital images that were overlapped. According to the results, geometric calibration gives reasonable alignment between thermal and digital images, up to some extent. Yet at the same time, there appears to be some geometric distortion due to the perspective correction. However, the heat loss from the door can easily be distinguished. It can be said that the door is rather leaky and needs to be air-tightened, while the temperature gradient shows that the overall heat transfer coefficient of the door does not need any improvement.

The figure on the right shows the 3D spatio-thermal model of the corridor. The results indicate that the calculated errors for the wall lengths and room height are 2–3 %. The errors occur due to distance between corner point and smartphone camera. The closer to the corner point the less the errors. Besides, mobility and the measurement process from a certain distance causes relative errors due to effect of shaky hands, which can also be reduced from closer distance. The thermal image superimposed onto the 3D spatial model, illustrates the location of the energy diagnostics clearly, even though the rest of the image shows spatial data only.

4. CONCLUSIONS AND FUTURE WORKS

In this study, a coupled 3D spatial reconstruction and energy diagnostics of building interiors were investigated. The results demonstrate that the 3D spatial reconstruction of a room can be generated with a 3D-aware smartphone in approximately five minutes, which is far less than earlier documented case studies. Besides, missing and incomplete spatial CAD information in many historic buildings can be updated and digitalised this way. Thermal mapping and energy diagnostics of the same space can be simultaneously obtained,

provided by the infrared camera integrated into the same smartphone. One of the significant outcomes of this study is that a smartphone application can be programmed, so that the data gathered from the smart devices can be manipulated according to the needs. This approach also diminishes the need for destructive, time consuming or labour-intensive work needed to accomplish the same coupled diagnostics.

The results indicate that this approach can be used in the decision making process of energy saving measures in historic buildings due to localising and illustrating the diagnosed area in 3D space enhancing the understanding.

This study shows that the proof-of-the concept proposed is working effectively. Yet, the approach can be further improved considering the following points:

- The extrinsic calibration can be conducted between the thermal and the digital camera of a smartphone in order to improve the geometric alignment;
- Overall heat transfer coefficient (U-value) of the walls can be determined with the use of additional coding of heat transfer equations, or with the help of additional sensors controlled by the smartphone itself;
- Modelling of windows and doors can be added into the 3D spatial reconstruction model for more detailed investigation;
- The 3D spatial model and its embedded information can be used to generate Building Information Modelling (BIM)-based energy simulation model and can be exported;
- Mapping condensation and mould growth issues in historic buildings on the 3D spatial model can be investigated, provided by the surface and indoor temperature obtained from thermal camera.

5. REFERENCES

- [1] F. Berg, A.C. Flyen, A.L. Godbolt, T. Broström. "User-driven energy efficiency in historic buildings: A review" *Journal of Cultural Heritage*, vol. 28, pp. 188–195, Nov-Dec 2017.
- [2] Comité Européen de Normalisation. Conservation of cultural heritage – Guidelines for improving the energy performance of historic buildings TC 346, EN 16883:2017
- [3] E. Lucchi. "Applications of infrared thermography in the energy audit of buildings: A review" *Renewable and Sustainable Energy Reviews*, vol. 82, pp. 3077–3090, Feb 2018.
- [4] Y. Ham. (2015). Dissertation, Doctor of Philosophy. Vision-Based Building Energy Diagnostics and Retrofit Analysis Using 3D Thermography and Building Information Modelling. University of Illinois at Urbana-Champaign.
- [5] Y.K. Cho, Y. Ham, M.Golparvar-Fard. "3D as-is building energy modelling and diagnostics: A review of the state-of-the-art" *Advanced Engineering Informatics*, vol: 29(2), pp 184–195, April 2015.
- [6] L.Lopez-Fernandez, S.Lagüela, D.Gonzalez-Aguilera, H. Lorenzo. "Thermographic and mobile indoor mapping for the computation of energy losses in buildings" *Indoor and Built Environment*, vol. 26(6) pp. 771–784, July 2017.
- [7] S.Vidas, P.Moghadam. "HeatWave: A handheld 3D thermography system for energy auditing" *Energy and Buildings*, vol.66 pp: 445–460, Nov 2013.

- [8] A. Sankar. (2017). Dissertation, Doctor of Philosophy. Interactive In-Situ Scene Capture on Mobile Devices. University of Washington.
- [9] FLIR One Pro. Data Sheet. Available: <http://www.flir.eu/uploadedFiles/Store/Products/FLIR-ONE/3rd-Gen/FLIR-ONE-Pro/FLIR-ONE-PRO-Datasheet.pdf> [Feb. 28, 2018].
- [10] iPhone 7. Available: <https://www.apple.com/iphone-7/specs/> [Feb. 28, 2018]
- [11] Matlab version R2017b. Available: <https://www.mathworks.com/products/matlab.html> [Feb. 28, 2018].
- [12] Apple Inc. 2017. Introducing ARKit: Augmented Reality for iOS. Available: <https://developer.apple.com/arkit/> [Feb. 28, 2018].

Combining multi-view photogrammetry and wireless sensor networks when modelling the hygrothermal behaviour of heritage buildings

S. Dubois¹, M. de Bouw^{1,2}, Y. Vanhellemont¹, D. Stiennon³ and S. Trachte³

¹ Dept. Sustainable Development and Renovation, Belgian Building Research Institute, BBRI, Limelette, Belgium. Email: sdu@bbri.be

² Faculty of Design Sciences, Master of Heritage Sciences, University of Antwerp, Antwerp, Belgium.

³ Architecture et Climat, Université Catholique de Louvain, UCL, Louvain-la-Neuve, Belgium.

Abstract – The construction sector has now entered the ‘Digital era’, and professionals are slowly getting familiar with many of these innovative technologies. This paper shows how such innovations improve the investigation phase when it comes to energy retrofits on heritage buildings. More specifically, multi-view photogrammetry and wireless sensor networks can facilitate the implementation and enhance the relevance of building hygrothermal and energy simulations: photogrammetry quickens up the reproduction of the building geometry whereas wireless sensor networks facilitate and enlarge the collection of data relative to the existing behaviour of an occupied building.

This paper explores the benefits of using those two technologies compared to more traditional solutions, regarding data quality and general workflow. In this purpose, two case studies from research projects ongoing in Belgium are briefly described.

Keywords – heritage buildings, energy efficiency, wireless sensor networks, multi-view photogrammetry, structure from motion, high definition surveying

1. INTRODUCTION

1.1 INVESTIGATING HERITAGE BUILDINGS IN THE ‘DIGITAL ERA’

The rationalization of energy consumption in heritage buildings is a key step in making them more attractive – by reducing bills and improving the comfort [1]. Nevertheless, answering this challenge without harming the heritage values implies a well thought-out approach. If the specific hygrothermal behaviour of old dwellings is not taken into consideration, the risk of exacerbating existing pathologies is important. This implies that experts involved in the energy retrofits of heritage buildings need to be properly trained. Many research initiatives from the last years focused on providing guidelines for improving those competences [2]–[4].

For each energy retrofit project, one of the crucial aspects to deal with is the planning and implementation of a relevant investigation phase to characterize the building. It requires using the adequate sensing and modelling methods to guarantee a holistic grasp. Within the investigation, understanding the dynamic hygrothermal equilibria that take place in an ancient building is the key step

in choosing the most appropriate interventions. For this purpose, the specific behaviour of the building can be described by numerical models that predict the response of the building or one of its components when submitted to different climatic conditions. In the context of the 'Industry 4.0' paradigm [5], many new numerical tools and technologies are becoming available to the heritage experts and enrich the well-established traditional approaches. This paper shows how innovative 3D imaging and wireless monitoring solutions enhance the collection of input data for hygrothermal modelling.

1.2 MULTI-VIEW PHOTOGRAMMETRY

High-definition 3D digitization technologies revolutionized the building surveying and recording processes, which are crucial when working on heritage. Those mass data collection techniques [6] allow recording the surface of an object in a very precise way, with colour information and fine details transcription (Figure 1). Among the available methods, the 'Multi-View Photogrammetry' (MVP) is based on the automatic matching of several (digital) images: the three-dimensional topography of an object is rebuilt from different points of view of the object by means of an algorithm that combines 'structure from motion' and 'multi-view stereo' approaches. A clear overview of the underlying computational aspects can be found in [7]. The 3D point clouds or meshes stemming from HD surveying techniques not only offer a strong visualization and documentation support, but also serve as basis for many advanced numerical studies. In that respect, the handling and transformation of 'raw 3D models' into useful deliverables is more and more documented [8], [9].

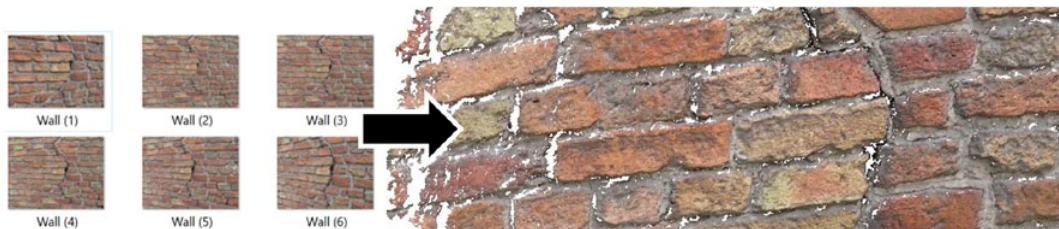

Figure 1. Point cloud generated from photographs of a wall with a MVP software.

1.3 WIRELESS SENSOR NETWORKS

A holistic hygrothermal study of a building often implies to monitor physical variables to confirm hypotheses concerning its behaviour. The sensors and systems dedicated to this task are evolving constantly. Research-dedicated monitoring systems consisted first of specialized data-logging stations connected to various wired sensors. Battery-operated sensors with embedded logging capabilities naturally followed with the development of low power integrated circuits. Today the 'Internet of Things' is gaining popularity [10] and many innovative wireless communication protocols are being deployed, allowing data to be transmitted remotely using radio frequencies [11]. As a result, 'Wireless Sensor Networks' (WSN) were developed. In their simplest form, they combine

sensor nodes and gateways for the end-transmission of data to the user [12], [13]. With WSN, all sensor measurements are more easily accessible because they are gathered in a single location in the building, and even stored on cloud servers.

Parallel to the diversification of sensor communication schemes, the development of hardware and software based on an open-source approach has gained much attention [14]. The success of open-source development boards and the dynamic user's community should encourage heritage experts to develop more WSN solutions tailored for the study of traditional buildings.

2. COMBINING MVS AND WSN WHEN MODELLING THE HYGROTHERMAL BUILDING PERFORMANCE

When it comes to hygrothermal modelling, three physical fields can be described in a building, i.e. the heat, air and moisture fields, and three geometrical regions, i.e. the exterior air, the building envelope and the interior air regions [15], [16]. Various types of hygrothermal models exist and each category generally focuses on some of these domains [17].

Building Energy Simulation (BES) models are frequently used to assess the energy efficiency of entire buildings. Most are based on the assumption that the air of each room is well mixed and associated with a single temperature value (multi-zone models). Each zone is then described with a heat balance that includes all energy-related loads. The description of moisture transfers is often very simplified. *EnergyPlus* is a well-spread example of such tools. Other models focus on the detailed description of the transient and coupled transfers in specific envelope parts. Most of the time they are simply referred to as Heat, Air and Moisture (HAM) models, but we prefer the denomination Building Element HAM (BEHAM) simulation tools [18] to avoid confusion with the other types of hygrothermal models. *Wufi* and *Delphin* are two popular commercial BEHAM software examples.

Each instance of a hygrothermal model requires a series of inputs: the geometry of the modelled region(s), the hygrothermal parameters of each material forming those regions, the hygrothermal conditions at their boundaries, and zone loads for BES simulations (e.g. occupancy conditions, heat sources). The impact of renovation or restoration interventions can only be evaluated once the model is properly calibrated. Even if an initial parameter estimation is crucial, only well-thought monitoring campaigns will effectively support the model calibration phase. Any method that allows increasing the quality of the initial input data or the calibration material is then precious. Figure 2 shows how MVP and WSN intervene in multiple points of the modelling workflow.

The geometry of heritage buildings is complex by nature. Advanced survey techniques such as MVP could capture this complexity and speed up the creation of the whole-building energy models. Photo-based 3D reconstructions are also very rich in textural information that can help the visual analysis of walls composition.

Collecting relevant hygrothermal data through monitoring systems is a hard task. Especially when it implies to instrument an occupied building. Typical monitoring systems are either too invasive (e.g. cables running through the house, large central data logger) or too restrictive (e.g. commercial battery-operated sensor with local storage of data). The development of WSN tends to miniature and polyvalent solutions that are deeply desirable. For the expert, it is a chance to multiply the type of variables that can be monitored and the number of sensors that can be implemented in a building without disturbing the occupants. In particular, 'hybrid' sensor networks that combine commercial and open-source hardware seem to be a powerful solution.

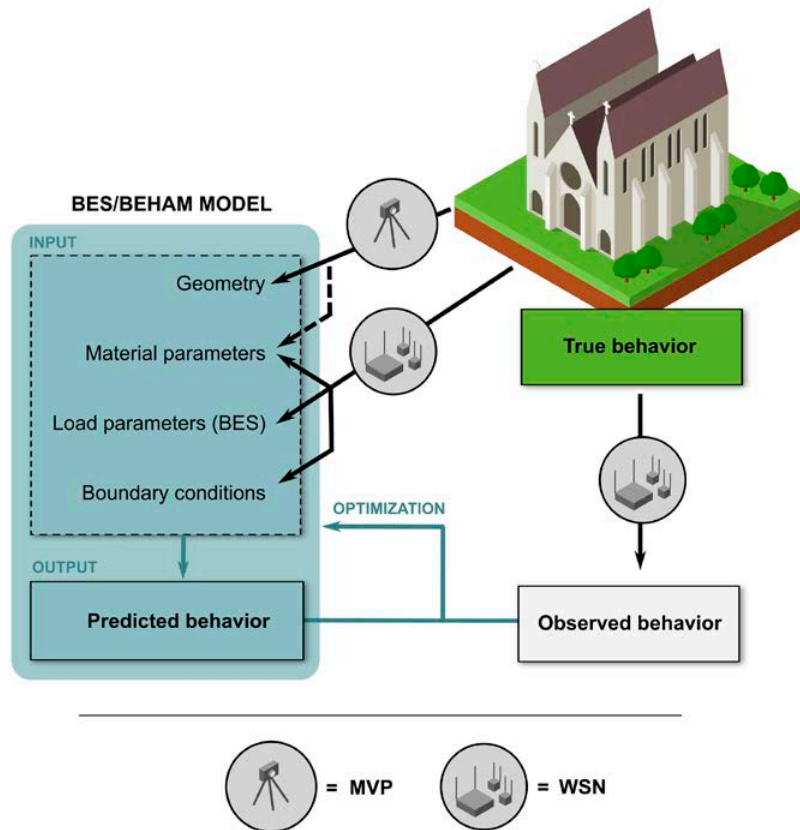

Figure 2. Complementarity of Multi-View Photogrammetry and Wireless Sensor Network to improve the hygrothermal modelling of heritage Buildings.

3. RESEARCH PROJETS AND CASE STUDIES

The combined use of MVP and WSN techniques is currently analysed in two on-going projects that are led by the *Belgian Building Research Institute* in Belgium. Both projects focus on proposing adequate solutions to improve the energy efficiency and comfort of heritage buildings. In Flanders, the project *ErfgoedEnergieLoket*, spanning from 2014 to 2021, focuses on answering the need for energy consultants specialized in architectural heritage. The key measure is the elaboration of a training program intended for restoration archi-

pects. The teaching material was enriched through an investigation program carried out on protected buildings [19]. In Wallonia, the research project *P-Renewal*, extending from 2017 to 2021, aims to develop a methodological tool providing strategies of energy refurbishment and sustainable retrofit of historical Walloon dwellings with heritage value and built before 1914.

Figure 3 and 4 show the two case studies chosen here as illustration. Building A is a one-storey 18th century detached house located in Mellier. Building B is a one-storey 20th century villa located in Tervuren. The energy efficiency and the comfort of both buildings needed to be assessed in order to propose and evaluate adequate retrofitting strategies. It implied to create a BES model for each of them.



Figure 3. Building A: a case study in Mellier. Photo: Samuel Dubois.



Figure 4. Building B: a case study in Tervuren. Photo: Samuel Dubois.

Building A was surveyed with the MVP technique, using 918 photographs for the interior spaces reconstruction and 146 photographs for the exterior walls. *Agisoft Photoscan* software was used to generate dense clouds for the two domains. The interior and exterior models were aligned with control points, which were surveyed with a *Leica S910* laser distance measurer. Finally, the *CloudCompare* software was used to further process the point clouds.

The long-term monitoring system implemented in building B is a hybrid network (Figure 5) that combines commercial and tailored components. Commercial *Monnit* sensor nodes allow the monitoring of a wide range of ‘standard’ variables, such as the temperature and relative humidity of indoor air (Figure 6). Those ‘ready-to-deploy’ nodes are useful to deploy a monitoring basis, with a typical 15 min heartbeat interval. The various battery-operated nodes communicate their data to a proprietary gateway using 868 MHz radio frequency. In parallel, a tailored-made signal-processing unit was deployed to monitor heat fluxes through walls (Figure 7). An *Arduino*-based platform collects the analogic signal from a heat flux meter (Figure 8). Afterwards, it transforms the analog data into digital information and transmits it to a *Monnit* serial data bridge: this particular node from the commercial WSN system is the key here to the ‘hybridisation’ process. Once the bridge node gets the heat-flux data from the *Arduino*, through

RS232 wire communication, it transfers it to the *Monnit* gateway. Upstream of the network, a 3G router ensures that the *Monnit* gateway can communicate with internet, and reaches the cloud servers where all nodes data is stored.

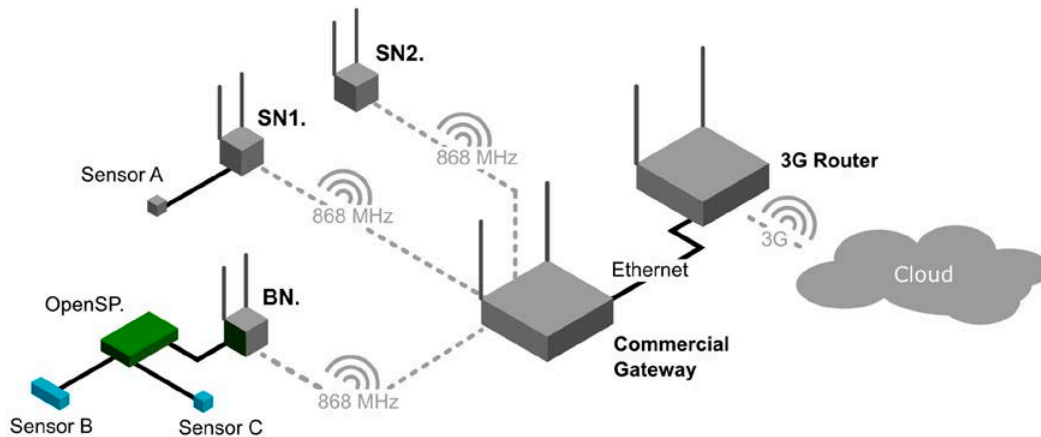

Figure 5. The flexibility of the 'hybrid' WSN system for the monitoring of heritage buildings. SN1 = Commercial sensor node with external sensor; SN2 = Commercial sensor node with internal sensor; BN = Commercial bridge node; OpenSP = Open source signal-processing unit.

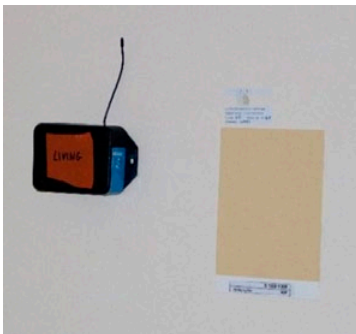

Figure 6. A temperature and humidity sensor node (commercial system) mounted on an interior wall in building B.

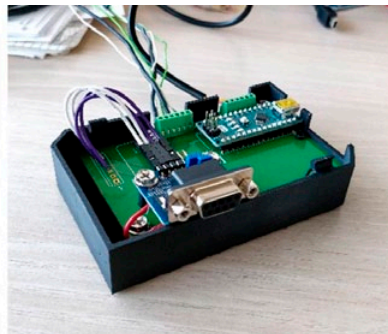

Figure 7. A tailored signal processing unit (open-source) to allow the measurement of heat flux.



Figure 8. A heat flux meter and temperature sensor integrated in the hybrid-WSN solution.

4. RESULTS AND DISCUSSION

Figure 9 shows the combined interior-exterior model generated from photographs of Building A. When performing cross-sections through this 'whole building' point cloud (Figure 9b), we obtain precious input for the geometric modelling of BES. All rooms are well delimited and the combination of their geometry with the exterior envelop provides the thickness of all walls. Orthomosaic photos, easily created from the exterior scan, also provide a strong modelling support (Figure 9c). They allow the drawing of windows or the recognition of material configurations, for example.

The benefits of the approach have to be balanced against some drawbacks. First, the workflow around high-definition 3D reconstructions remains very demanding in terms of computational power. Another important remark concerns the privacy of occupants, which has to be guaranteed throughout the study. Working with photographs is not easy in that respect. Finally, the intrinsic limitations of multi-view photogrammetry (e.g. the object to be reconstructed should not have a uniform colour), as well as the requirements in terms of input image quality should not be underestimated. That imposes to adequately prepare the photographic mission and take measures to validate the accuracy of the 3D reconstruction. In that respect, obtaining accurate and complete 3D models by photogrammetry requires some competences that can only be acquired by experience or proper training. Moreover, not all buildings are necessarily adapted to MVP studies.

Figure 10 shows a portion of the monitoring data collected with the hybrid WSN installed in Building B. More specifically, the heat flux going through one of the exterior walls is provided for a two-week period, together with the temperatures of the adjacent air spaces. Those three variables allow estimating the U-value of the wall, here with a dynamic prospect. The potential of the system was validated as all this data was obtained at a lower cost and with less clutter compared to a traditional logging solution. Advanced heat-flux measurement nodes could thus easily be multiplied within a single occupied building, without bothering the inhabitants too much. In fact, many types of advanced sensors could be deployed in a similar way. The remote access to data offered by this cloud-based WSN was also very useful, for communication purpose (measurements can be showed directly on a smartphone) or to intervene quickly in case of a system failure. An important attention point concerns the risk of losing data due to some miscommunications between the nodes and the gateway or from the gateway to internet.

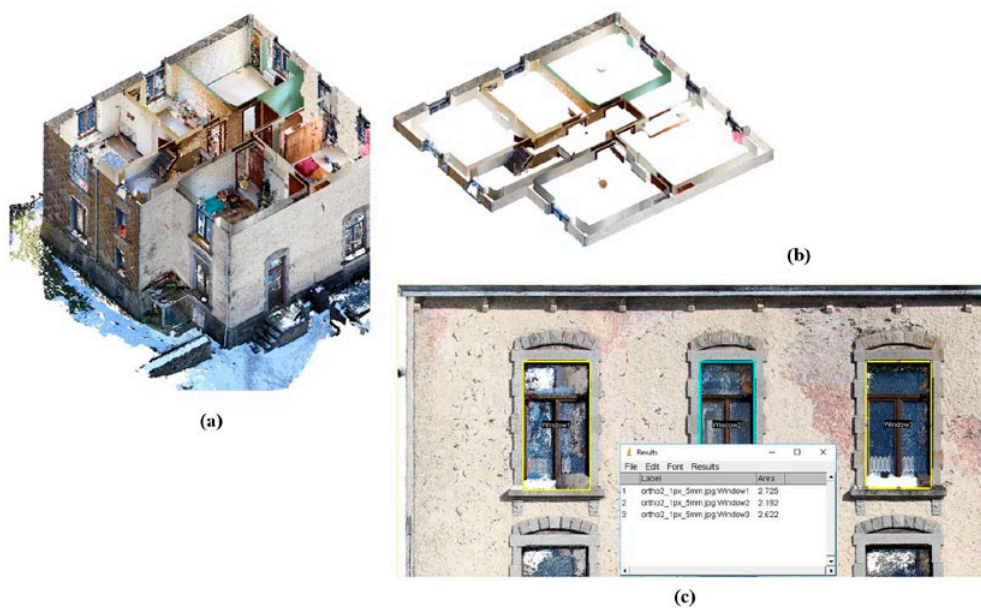

Figure 9. Building A surveyed with MVP: (a) model obtained by combining the interior and exterior reconstructions; (b) a cross-section through the whole-building 3D model; (c) drawings and measurements using an orthomosaic photo as support.

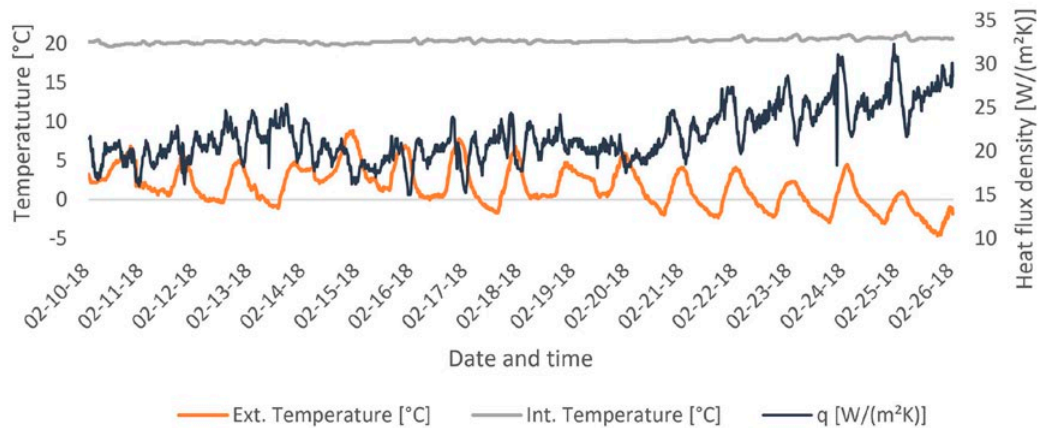

Figure 10. The hybrid WSN system makes it possible to monitor advanced variables remotely, such as the heat fluxes through walls.

5. PERSPECTIVES AND CONCLUSIONS

This paper showed how advanced digital solutions are revolutionizing the work of heritage experts. When it comes to implementing high quality energy retrofits, it is clear that numerical technologies cannot be put aside. We showed that MVP and WSN both improve the hygrothermal and energy modelling workflow, which is a critical stage when investigating potential energy-related interventions. MVP mainly improves the completeness of the geometrical input data. High-quality interior and exterior 3D reconstructions were created with a simple equipment. Combined, the two point clouds provide a holistic geometric dataset. A practical and direct use of this data is the creation of the geometry within a multi-zone building energy simulation. In parallel, WSN proved to be extremely interesting to enlarge the hygrothermal monitoring possibilities in occupied buildings, without causing too much disturbance for occupants. Hybrid systems, which combine ready-to-use sensor nodes and gateways with tailored solutions, open the way to advanced studies at a low cost.

6. REFERENCES

- [1] M. de Bouw, S. Dubois, L. Dekeyser and Y. Vanhellement. Proceedings of International Conference on Energy Efficiency in Historic Buildings, 2016. [Online]. Available: https://www.eechb.eu/wp-content/uploads/2016/12/Proceedings_EECHB.pdf
- [2] A. Troi, Z. Bastian. Energy Efficiency Solutions for Historic Buildings – A Handbook. Basel: Birkhäuser, 2014.
- [3] A. Martínez-Molina, I. Tort-Ausina, S. Cho, and J.-L. Vivancos. “Energy efficiency and thermal comfort in historic buildings: A review,” in *Renew. Sustain. Energy Rev.*, vol. 61, pp. 70–85, 2016.
- [4] P. Eriksson, C. Hermann, S. Hrabovszky-Horváth and D. Rodwell. “EFFESUS methodology for assessing the impacts of energy-related retrofit measures on heritage significance,” in *Hist. Environ. Policy Pract.*, vol. 5, no. 2, pp. 132–149, 2014.

- [5] M. Brettel, N. Friederichsen, M. Keller, and M. Rosenberg. "How virtualization, decentralization and network building change the manufacturing landscape: An Industry 4.0 Perspective," in *Int. J. Mech. Ind. Sci. Eng.*, vol. 8, no. 1, pp. 37–44, 2014.
- [6] D. Barber and J. Mills. "3D laser scanning for heritage: Advice and guidance to users on laser scanning in archaeology and architecture". *English Heritage*, 2007. [Online]. Available: <https://historicengland.org.uk/images-books/publications/3d-laser-scanning-heritage/> [February 26, 2018].
- [7] Y. Furukawa and C. Hernandez. *Multi-View Stereo: A Tutorial*. Delft: now Publishers, 2016.
- [8] S. Dubois, M. de Bouw, and Y. Vanhellemont. "Innovation Paper: le relevé géométrique à haute définition – La numérisation 3D à l'heure du BIM". CSTC-WTCB-BBRI. [Online]. Available : www.cstc.be/homepage/index.cfm?cat=services&sub...InnovationPapers [January 20 2018].
- [9] J. Bedford. "Photogrammetric Applications for Cultural Heritage – Guidance for good practice". *Historic England*, 2018. [Online] -. Available: <https://historicengland.org.uk/images-books/publications/photogrammetric-applications-for-cultural-heritage/> [February 28 2018].
- [10] L. Atzori, A. Iera, and G. Morabito. "The internet of things: A survey," in *Comput. Netw.*, vol. 54, no. 15, pp. 2787–2805, 2010.
- [11] J. Gubbi, R. Buyya, S. Marusic, and M. Palaniswami. "Internet of Things (IoT): A vision, architectural elements, and future directions," in *Future Gener. Comput. Syst.*, vol. 29, no. 7, pp. 1645–1660, 2013.
- [12] L. Mottola and G.P. Picco. "Programming wireless sensor networks: Fundamental concepts and state of the art," in *ACM Comput. Surv. CSUR*, vol. 43, no. 3, p. 19, 2011.
- [13] D. Bhattacharyya, T. Kim, and S. Pal. "A comparative study of wireless sensor networks and their routing protocols," in *Sensors*, vol. 10, no. 12, pp. 10506–10523, 2010.
- [14] R. Fisher, L. Ledwaba, G. Hancke, and C. Kruger. "Open hardware: A role to play in wireless sensor networks?," in *Sensors*, vol. 15, no. 3, pp. 6818–6844, 2015.
- [15] A. Janssens, M. Woloszyn, C. Rode, A. Sasic-Kalagasidis, and M. De Paepe. "From EMPD to CFD—overview of different approaches for Heat Air and Moisture modeling in IEA Annex 41," *IEA ECBCS Annex 41*, pp. 9–20, 2008.
- [16] D. Costola, "External coupling of building energy simulation and building element heat, air and moisture simulation," *Technische Universiteit Eindhoven*, Eindhoven, The Netherlands, 2011.
- [17] S. Dubois. "Modelling the hygrothermal behaviour of crop-based construction materials" PhD Thesis, Gembloux Agro-Bio Tech, 2010.
- [18] H. Hens. "Modelling, Heat Air and Moisture Transfer in Insulated Envelope Parts," *Final Rep. IEA-Annex*, vol. 24, 1996.
- [19] M. de Bouw, S. Dubois, S. Herinckx, and Y. Vanhellemont. "Specialized energy consultants for architectural heritage," in *Proceedings of International Conference on Energy Efficiency in Historic Buildings*, 2014.

Data fusion to synthesise quantitative evidence, value and socio-economic factors

A framework and example of Dempster-Shafer theory

S.A. Orr

*School of Geography and the Environment, University of Oxford, Oxford, United Kingdom.
Email: orr.scott@gmail.com*

Abstract – This paper presents a framework and example of how fuzzy data fusion processes can support decision making for energy efficiency in historic buildings. Dempster-Shafer (DS) theory is a framework of reasoning that deals with uncertainty, allowing one to combine evidence from different sources. DS theory can handle conflicting information, with the aim to provide a representation of the appropriateness and uncertainty for each option. The theory starts with a set of possibilities: for example, a range of retrofit options or energy-use schemes. Each one is assigned a degree of belief depending on how many evidence inputs contains the proposition and the subjective probability. DS theory incorporates hard data, e.g. energy models and economic estimates, and opinion, e.g. disruption to activities and changes in aesthetics. It is proposed that DS Theory and hard-soft data fusion algorithms provide an approach that can incorporate value and socio-economic aspects into decision making.

Keywords – decision making; data fusion; artificial intelligence; uncertainty; conflict resolution

1. INTRODUCTION

Making decisions on aspects of energy efficiency in historic buildings is complex [1]. There are several considerations, including technological feasibility, economy, impact on the historic character, etc. Each consideration is perceived differently by stakeholders – including managers, consultants, practitioners, occupants, and members of the public – based on their understanding of the issues and ability to confidently express an opinion. Trying to balance these inputs during a decision making process is subjective. These processes can be supported by using data fusion techniques.

Data fusion, or information fusion, is a method of combining input from multiple sources to produce information that is more consistent, accurate, and/or useful. It emerged from the need to combine sensors to improve military target tracking manufacturing precision [2]. In traditional approaches, the ‘sensors’ used were providing ‘hard’ data, i.e. quantitative information with associated precision and accuracy. More recently, interest in data fusion techniques that can incorporate ‘soft’ data has grown [3]. One technique capable of this is the Dempster-Shafer (DS) theory [4,5], also known as the theory of belief functions. It is a framework for combining evidence and dealing with uncertainty. The theory allows evidence from different sources to be combined resulting in a degree of belief that

considers all available evidence. Due to its power as a decision making tool, DS theory has been applied in a range of fields including artificial intelligence [6], environmental impact [7] and building risk assessment [8].

Bayesian methods are commonly applied in energy retrofit decision making processes [9]. Bayesian approaches aim to assign a probability to each potential outcome. In contrast, DS theory allows for a probability to be assigned to a set of outcomes [10], e.g. the probability of one outcome or another. In this way, DS theory allows for more flexibility when assigning probabilities from evidence, and can be considered a generalization of Bayesianism. Bayesian methods require more information *a priori* to 'condition' the probabilities; DS theory does not rely on prior knowledge, making it particularly suited to situations in which it is difficult to collect or hypothesise probabilities [11].

This paper outlines the framework of Dempster-Shafer theory and introduces some of the metrics that can be used to assess the uncertainty of the output. Following this, an example is given of how the theory might be used as part of selecting a proposal from many to improve energy efficiency in a historic built context.

2. THEORY AND DEFINITIONS

2.1 DEMPSTER-SHAFFER THEORY

The classical definition of Dempster-Shafer theory is given, followed by additional metrics to incorporate the degree of conflict and subsequent developments in uncertainty measures.

Let $\Theta = \{\theta_1, \theta_2, \dots, \theta_N\}$ be a finite nonempty set of mutually exclusive and exhaustive events, referred to as the frame of discernment (FOD). The power set of 2^N elements represents all possible combinations of the elements of the FOD and is denoted as follows:

$$2^\Theta = \{\emptyset, \{\theta_1\}, \{\theta_2\}, \dots, \{\theta_N\}, \dots, \{\theta_1, \theta_2, \dots, \theta_i\}, \dots, \Theta\}, \quad (1)$$

in which \emptyset represents the null set.

A *mass function* m is defined as a mapping from the power set 2^Θ to the interval $[0,1]$, which must meet the following criteria [4,5]:

$$\sum_{A \in \Theta} m(A) = 1. \quad (2)$$

If $m(A) > 0$, then A is a *focal element* for which there is supporting evidence. An $m = 0$ represents no evidence for an element, while $m = 1$ represents complete certainty.

The set of mass values associated with a single piece of evidence is called a *body of evidence* (BOE), often denoted $m(-)$ [12]. Each BOE is a subset of the power set 2^Θ meeting (2), in which each $A \in m(-)$ has an associated non-zero mass value m .

Two independent mass functions, m_1 and m_2 , can be combined with Dempster's rule of combination to produce a *joint mass* $m_{1,2}$ defined as [4,5]:

$$m_{1,2}(A) = (m_1 \oplus m_2)(A) = \frac{1}{1-k} \sum_{B \cap C = A} m_1(B)m_2(C), \quad (3)$$

where A, B, and C are non-unique elements of the BOE, and k is used to for the *degree of conflict* between m_1 and m_2 , defined as:

$$k = \sum_{B \cap C = \emptyset} m_1(B)m_2(C). \quad (4)$$

Conflict occurs when elements B and C do not have any intersecting events. The normalisation process ensures that $m_{1,2}$ meets the criteria in (2).

2.2 EVALUATING THE BELIEF INTERVAL

For each element of a set, the upper and lower bounds of a probability interval can be defined. This interval contains the precise probability of a set, and is bounded by two non-additive continuous associated measures for a set A called the belief function $Bel(A)$ and plausibility $Pl(A)$, defined respectively as [4,5]:

$$Bel(A) = \sum_{B|B \cap A} m(B). \quad (5)$$

$$Pl(A) = \sum_{B|B \cap A \neq \emptyset} m(B). \quad (6)$$

The belief $Bel(A)$ is the sum of the masses $m_{i..N}$ that are subsets of set A, i.e. those that directly provide evidence for that set. The plausibility $Pl(A)$ is the sum of the intersecting masses to set A, i.e. those that *could* provide evidence for that set but cannot be further subdivided into component scenarios. The size of the interval $[Bel(A), Pl(A)]$ characterises the confidence of the probability, not the certainty of a claim. The Pignistic function [13] represents the extent to which we fail to disbelieve A, defined as:

$$BetP(A) = \sum_{B \subseteq \Theta, B \neq \emptyset} m(B) \frac{|A \cap B|}{|B|} \quad (7)$$

3. FRAMEWORK FOR APPLYING THE DS-THEORY

A framework for applying DS theory in decision making is presented in Figure 1. The application of DS theory to decision making process first involves collecting evidence. This can take many forms, comprising both 'hard' data (e.g. models, experimental trials), and 'soft' data (e.g. testimonies, surveys). Other types of input are also possible.

These inputs are converted into bodies of evidence, each of which is a set of mass functions satisfying (2). It is not necessary that every element of 2^Θ is addressed by each BOE. A unique feature of DS theory is the ability to analyse

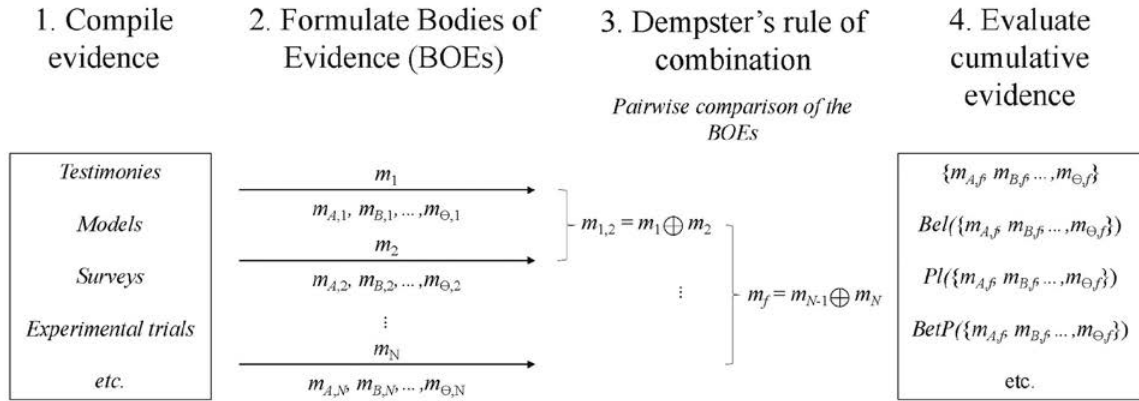

Figure 1. Framework for applying Dempster-Shafer theory to decision making processes.

incomplete information. More realistically, each BOE will address a small subset of the frame of discernment (\oplus). Once the BOEs have been formulated, they are combined in pairs through Dempster's rule of combination. The order in which the BOEs are combined is irrelevant, as the final set of cumulative mass functions m_f will be the same. m_f can then be evaluated by comparing the mass, belief, plausibility, and Pignistic functions.

4. EXAMPLE

4.1 INTRODUCTION

The utility of DS theory in supporting decision making processes is demonstrated with a simple scenario incorporating a hard and soft data input, which is worked through the framework given in Section 3. A third piece of evidence is provided to demonstrate the process for a multi-stage combination.

4.2 SCENARIO

An energy appraisal has been conducted for a museum that is housed in a historic building with protected status. Three options are considered to reduce the energy consumption of the building:

- 1) Retrofit with visible change to the historic fabric (option A);
- 2) Retrofit with minimal visible change to the historic fabric (option B);
- 3) Change environment conditions specifications to reduce HVAC load (option C)

4.3 COMPILE EVIDENCE

Two methods of evaluation are used to try and select the best option:

- A building surveyor with significant experience makes a detailed assessment of the building and its function (soft data);
- An energy consumption model is created by a consultant company and run under various stochastic scenarios (hard data).

The surveyor's report specified that they are somewhat confident that a retrofit would be effective. They meet with the building management to discuss the survey results. During this, they mention a similar project they recently worked on

where changing the environment only provided a small savings in energy. Due to this, they are quite sceptical of this being an effective technique.

The modelling exercise has the following outputs: to meet financial targets an energy consumption target of 40 % reduction is set. The model did not have the ability to estimate the savings in a scenario where a bespoke non-visible retrofit was undertaken. Under the various scenarios, 80 % of iterations met the target reduction in energy consumption.

4.4 FORMULATE BODIES OF EVIDENCE

In this scenario, we assume that one of the options explored will be more effective than the others (i.e. the null set is 0). Let m_1 represent the surveyor’s body of evidence. To translate their evidence to a quantitative scale, let us map confidence to a numeric scale: absolutely confident (100 %), very confident (80 %), somewhat confident (60 %), not very confident (40 %), not confident at all (20 %), don’t know/not sure (0 %). Therefore, the surveyor is 60 % certain that a retrofit option would be effective. Unfortunately, their report did not break this down between the visible and non-visible options. Let us equate ‘sceptical’ with ‘not confident at all’. The BOE m_1 from the surveyor would be comprised of the following elements: visible or minimally visible change: $m_1\{A,B\} = 0.6$; change environmental specifications: $m_1\{C\} = 0.2$; any option: $m_1\{A,B,C\} = 0.2$. The final element represents that no further preference was expressed in the surveyor’s evidence that distinguishes between the three options, and accounts for the remaining certainty to meet the criteria in (2). It is implied that all other possible outcomes (e.g. visible change *only* {A}, minimally visible change *only* {B}, etc.) have $m = 0$.

The modelling exercise provided information on option A. Based on the model output and the consumption reduction target of 40 %, the model predicts that this will be achieved in 80 % of scenarios. To this end, the model BOE m_2 can be expressed as: visible change: $m_2\{A\} = 0.8$; any option: $m_2\{A,B,C\} = 0.2$. In a similar manner, the second element represents the unexpressed indifference between the three options when taking a modelling approach.

4.5 DEMPSTER’S RULE OF COMBINATION

It is useful to set up an ‘intersection tableau’ for computational purposes (Table 1) [14]. Let m_3 denote the combination between the surveyor’s evidence m_1 and the model output m_2 . In this case, there is one non-intersecting element, so $k = m_1\{C\} \oplus m_2\{A\} = (0.2)(0.8) = 0.16$.

Table 1. Intersection tableau for Dempster’s rule of combination in the Scenario set out in Section 4.1

m_2	m_1		
	$m_1\{A,B\} = 0.6$	$m_1\{C\} = 0.2$	$m_1\{A,B,C\} = 0.2$
$m_2\{A\} = 0.8$	$m_3\{A\} = (0.6)(0.8)/k = 0.571$	<i>Non-intersecting</i>	$m_3\{A\} = (0.2)(0.8)/k = 0.190$
$m_2\{A,B,C\} = 0.2$	$m_3\{A,B\} = (0.6)(0.2)/k = 0.143$	$m_3\{C\} = (0.2)(0.2)/k = 0.048$	$m_3\{A,B,C\} = (0.2)(0.2)/k = 0.048$

4.6 EVALUATE CUMULATIVE EVIDENCE

From the cumulative evidence m_3 calculated in Section 4.4, a summary of the functions can be compiled (Table 2).

Table 2. Summary of cumulative functions

Scenario		m_3	Bel	PI	Bel interval (probability range)	Bel interval	BetP
Visible change	{A}	0.761	0.761	0.952	[0.761, 0.952]	0.191	0.849
Environmental specifications	{C}	0.048	0.048	0.096	[0.048, 0.096]	0.048	0.064
Visible or minimally visible change	{A,B}	0.143	0.904	0.952	[0.904, 0.952]	0.048	0.175
Any option	{A,B,C}	0.048	1.00	1.00	[1.00, 1.00]	0	0.048
TOTAL	-	1.00	2.71	3.00	-	-	1.14

m_3 represents the combined mass functions from our two bodies of evidence: the surveyor and the model. In this section, all elements refer to m_3 . We can see that the ordered magnitudes are: $m_3\{A\} > m_3\{A,B\} > m_3\{C\} > m_3\{A,B,C\}$.

This demonstrates that the combined evidence supports the visible retrofit {A} most strongly, followed by one of the retrofit options {A,B}. There is no strong case for environment specifications {C}, since $|m_3\{C\}| = |m_3\{A,B,C\}|$, i.e. the cumulative evidence for changing environment specifications is equal to the evidence supporting any option.

It is important to note that Bel and PI do not sum to 1. The belief represents the masses of evidence that directly supports an element, i.e. the minimum amount of confidence we have in it. As the visible option {A} is a component that supports belief that the set {A,B} (either retrofit option) has a higher Belief; $\text{Belief}(\{A,B\}) = 0.143 + 0.761 = 0.952$.

The plausibility represents the masses that *could* support an element. For example, the plausibility of any option having the strongest case is 1.00 since all other elements are subsets of it, therefore supporting it: $\text{PI}(\{A,B,C\}) = 0.761 + 0.048 + 0.143 + 0.048 = 1.00$.

The Belief interval is the range of probabilities that an element is the ideal option according to the evidence provided. The size of the interval represents how certain we are of that probability. For example, the Belief interval for {A,B,C} is 0, since we defined that the null hypothesis = 0. It could have been allowed that a body of evidence does not support any of the options i.e. there is a non-zero null hypothesis.

Although there is less evidence directly supporting 'either retrofit option' A or B ($m\{A,B\} < m\{A\}$), they have the same plausibility. This means that they are equally plausible according to the full set of possibilities. The Belief interval for either retrofit {A,B} is smaller than a visible retrofit {A}, which means that we are more confident in one of the retrofit options being appropriate than we are that the visible option is appropriate. This is only because they have the same plausibility; having identically-sized Belief intervals does not mean they are equally

plausible or confident. Based on the Pignistic functions, we most significantly fail to disbelieve in the visible option{A}.

From this assessment, it can be concluded that a retrofit with visible changes is most strongly directed supported by the surveyor and the models, but it is equally plausible that either of the retrofit options could be appropriate. We fail to disbelieve the former, but we have more confidence in stating the probability of the latter.

4.7 A MULTI-STEP COMBINATION EXTENSION

4.7.1 Scenario

A second opinion is sought from a curator of the museum. They are certain that the historic elements of the building are a reason that many people visit. They are concerned that a retrofit with visible changes will affect the visitor experience and ultimately income. The curator doesn't have experience with changing environmental specifications but heard from a colleague that it had been effective in many cases to reduce energy consumption.

4.7.2 Formulating bodies of evidence

We already have the combined evidence from the surveyor and the model m_3 : $m_3\{A\} = 0.761$, $m_3\{C\} = 0.048$, $m_3\{A,B\} = 0.143$, $m_3\{A,B,C\} = 0.048$. We can produce from the curator a third *independent* body of evidence m_4 : $m_4\{C\} = 0.2$, $m_4\{A,B,C\} = 0.8$. Put another way, the curator thinks changing environmental specifications is a reasonable option to explore but is not confident that it will be appropriate. No opinions on retrofit options were provided.

4.7.3 Dempster's rule of combination

Another intersection tableau is created for $m_5 = m_3 \oplus m_4$ (Table 3), which has a $k = (0.8)*(0.761 + 0.143) = 0.723$ [$1-k = 0.277$]. It is important to note that partially due to reduced evidence provided by the curator, there is more conflict.

Table 3. Intersection tableau for Dempster's rule of combination combining the first two bodies of evidence with that representing the curator

m_4	m_3			
	$m_3\{A\} = 0.761$	$m_3\{C\} = 0.048$	$m_3\{A,B\} = 0.143$	$m_3\{A,B,C\} = 0.048$
$m_4\{C\} = 0.8$	Non-intersecting	$m_5\{C\} = 0.139$	Non-intersecting	$m_5\{C\} = 0.139$
$m_4\{A,B,C\} = 0.2$	$m_5\{A\} = 0.549$	$m_5\{C\} = 0.035$	$m_5\{A,B\} = 0.103$	$m_5\{A,B,C\} = 0.035$

The same metrics produced in the original scenario can be calculated for the new combined evidence (Table 4).

Table 4. Summary of cumulative functions

Scenario		m_s	<i>Bel</i>	<i>PI</i>	<i>Bel interval</i> (probability range)	<i> Bel interval </i>	<i>BetP</i>
Visible change	{A}	0.549	0.549	0.687	[0.549, 0.687]	0.138	0.612
Environmental specifications	{C}	0.313	0.313	0.348	[0.313, 0.348]	0.035	0.325
Visible or minimally visible change	{A,B}	0.103	0.562	0.687	[0.562, 0.687]	0.125	0.126
Any option	{A,B,C}	0.035	1.00	1.00	[1.00, 1.00]	0	0.035
TOTAL		1.00	2.42	2.72	-	-	1.10

Now, the mass of a visible retrofit {A} has been reduced by the curator's support for changing environment conditions {C}. Since no evidence for options A or B was given {A,B}, the visual retrofit {A} still has the same (but reduced) plausibility as either retrofit option {A,B}. We are now almost equally confident in the probability that a visible retrofit and either of the retrofit options is most appropriate. As further evidence was given, the ambiguous mass supporting any of the options is reduced.

In contrast to quantitative evidence typically used to make retrofit decisions, the metrics used herein have specific benefits:

- a single piece of evidence can support multiple outcomes in a non-discrete manner;
- the Beliefs and Belief intervals represent the full range of potential probabilities, providing additional discussion beyond averaged metrics;
- no knowledge on the probability of each option is needed, since the Belief functions are formulated directly from the evidence provided.

5. FUTURE WORK

The example scenario included a limited number of bodies of evidence. There is no limit to the number of steps in Dempster's rule of combination, meaning that any number of evidences can be considered. With more bodies of evidence, it would become important to explore metrics that evaluate the degree of conflict between bodies. Future work will explore more complex scenarios (e.g. more bodies of evidence with a greater number of options and fuzziness) and conflict metrics.

6. CONCLUSION

Dempster-Shafer theory was applied to a simple decision making scenario, which demonstrated its ability to combine inputs from a variety of sources. This is especially pertinent for the historic environment in which complex issues must be addressed with a combination of quantitative and qualitative means. Data fusion techniques, such as Dempster-Shafer theory, are not meant to replace existing decision making processes. Hard-soft data fusion algorithms provide a tool that can support decision making by synthesising a diverse range of heritage conservation considerations into a cohesive output.

7. REFERENCES

- [1] K. Fouseki and M. Cassar. "Energy Efficiency in Heritage Buildings – Future Challenges and Research Needs". *The Historic Environment: Policy & Practice*, vol. 5, issue 2, pp. 95–100, 2014.
- [2] X.E. Gros. *NDT Data Fusion*. London, UK: Arnold (Hodder Headline), 1997.
- [3] B. Khaleghi, A. Khamis, F.O. Karray, S.N. Razavi. "Multisensor data fusion: A review of the state-of-the-art" *Information Fusion*, vol. 14, issue 1, pp. 28–44. October 2011.
- [4] A.P. Dempster. "Upper and lower probabilities induced by a multivalued mapping." *The annals of mathematical statistics*, vol. 38, issue 2, pp. 325–339. April 1967.
- [5] G. Shafer. *A Mathematical Theory of Evidence*. New Jersey, NY: Princeton University Press, 1976.
- [6] L.A. Zadeh. "A simple view of the Dempster-Shafer theory of evidence and its implication for the rule of combination". *Artificial Intelligence*, vol. 7, issue 2, pp. 85–90. June 1986.
- [7] N.B. Abdallah, N. Mouhous-Voyneau, and T. Denoeux. "Using Dempster-Shafer Theory to model uncertainty in climate change and environmental impact assessments". *Proceedings of the 16th International Conference on Information Fusion*, pp. 2117–2124, Istanbul, July 2013.
- [8] S. Tesfamariam, R. Sadiq, and H. Najjaran. "Decision Making Under Uncertainty – An Example of Seismic Risk Assessment. *Risk Analysis*, vol. 30, issue 1, pp. 78–94, January 2010.
- [9] Y. Heo, C Ruchi, and G.A. Augenbroe. "Calibration of building energy models for retrofit analysis under uncertainty", *Energy and Buildings*, vol. 47, pp. 550–560, April 2012.
- [10] K. Sentz and S. Ferson. *Combination of evidence in Dempster-Shafer theory*. Albuquerque, NM: Sandia National Laboratories, 2002.
- [11] J.C. Hoffman and R.R. Murphy. "Comparison of Bayesian and Dempster-Shafer Theory for Sensing: A Practitioner's Approach". *SPIE Proceedings on Neural and Stochastic Methods in Image and Signal Processing II*, vol. 2032, pp. 266–280, July 1993.
- [12] The-Crankshaft Publishing "The Dempster-Shafer Theory (Artificial Intelligence)" Internet: <http://what-when-how.com/artificial-intelligence/the-dempster-shafer-theory-artificial-intelligence/>, 13 December 2012 [19 February 2018].
- [13] P. Smets and R. Kennes. "The transferable belief model". *Artificial intelligence*, vol. 66, issue 2, pp. 191–234. April 1994.
- [14] J. Gordon and E. H. Shortliffe. "The Dempster-Shafer Theory of Evidence" in *Readings in uncertain reasoning*. G. Shafer and J. Pearl, Eds. San Mateo, CA: Morgan Kaufmann, 1984, pp. 529–539.

Value creation by re-renovation

Focus on the user perspective

P. Femenías¹, P. Eriksson², L. Thuvander¹, K. Mörk¹, P. Wahlgren¹ and P. Johansson¹

¹ Dept., of Architecture and Civil Engineering (ACE). Chalmers University of Technology, Gothenburg, Sweden

² Dept., of Conservation and Art History, Uppsala University, Visby, Sweden

Abstract – Historic multi-residential buildings that have been renovated at an earlier occasion are today facing new interventions. Re-renovation defines a concept for a second major renovation which opens up for the possibility of re-creating architectural and heritage values that has been lost in earlier renovations at the same time as demands for modernisation, energy efficiency, and economy are met. This paper focuses on what values heritage and historic buildings represent for residents, how they perceive the effects of energy renovation, what building elements they appreciate, and the implications for carrying out re-renovation. An empirical study of two cases with rental and owner-occupied housing has been applied combining a questionnaire survey (n= 83) and interviews (n=9). Findings indicate that historic buildings create values for their residents which should be considered by property owners when planning a renovation or re-renovation. Methodologically, asking residents about heritage values is challenging and the paper provides suggestions for further research in the field.

Keywords – multi-residential housing, renovation, energy-efficiency, user perspectives, cultural values

1. INTRODUCTION

Modernisation and energy efficiency is a challenge when renovating historic buildings. This paper presents on-going research focusing on modernisation and energy-efficiency of multi-residential buildings in Gothenburg, Sweden, constructed 1945 and before. Many of these buildings have already been modernised and renovated, notably with governmental support for energy saving in the 1970s and 80s. For part of the stock, the technical or economic service life has been reached for these measures, and new renovations are planned.

The research project investigates the concept of re-renovation, that is, a process that aims at restoring or improving the technical, environmental and economic performance of a building through a second major renovation while respecting the cultural and historical value. In addition, re-renovation provides an opportunity to restore or recreate architectural and historical values that have been lost in earlier interventions or renovations. In the case of multi-residential buildings, the value creation for the property owner but also for the users is of high importance. In this paper, the values that re-renovation creates for residents in historic buildings are in focus.

Earlier studies have pointed to the value of heritage for people, for example to perceive fellowship with other people and support an understanding of themselves and modern society [1]. In relation to urban renewal, studies from the 1960s and the 70s have shown that residents value their historic living environment, compared to planners and developers, that found the housing not liveable due to low standards [2]. A recent study supports an “irrational” behaviour with respect to heritage when home owners of historic buildings in Cambridge, UK, were found to value aesthetic as much as economy when deciding on energy improvements [3]. Finally, a study carried out in the county Halland, Sweden, shows that heritage values are connected to higher property values and that 63 percent of a population of 3259 owners or companies were willing to pay more to own or rent a building with heritage values [4].

1.1 AIM AND RESEARCH QUESTIONS

Based on two cases, that have been or are about to undergo re-renovation to improve the performance of the thermal envelope and recreate architectural expressions lost in earlier renovations, we investigate what these changes represent for the residents. The studied cases of re-renovation include the recreation of wooden façades that were replaced or covered with metal sheets and board in the 1970s. Explored questions relate to both the subject and method – logical challenges when approaching residents with the inquiry about cultural historical values:

- Do the residents express an interest in the cultural historical aspects of their home environment? What kind of building related qualities do they value or appreciate?
- How are these values balanced to other values created by the re-renovation such as better indoor climate or higher energy efficiency, and are they willing to pay for these?
- What methodological challenges are met when inquiring residents about cultural historical values in their home environment?

1.2 THE CASE AREAS

Two areas in Gothenburg, called Case A and B, have been studied (Table 1). Case A consist of three housing blocks A1-A3 with in total 156 rental apartments. Case area B consists of one block with 22 apartments, of which 20 are owner-occupied apartments and two are rental.

Table 1. Information about the two case areas

Case area	A1	A2	A3	B
<i>Number of apartments</i>	36	108	12	22
<i>Year of construction</i>	1937	1938	1937	1889
<i>Renovations</i>	1970s	1970s	1970s	1915, 1970s, 2005
<i>Recent renovation</i>	2016	Planned 2019	2013	2010

1.2.1 Building type and protection

Area A and B are *Landshövdingehus*, a local type of working class multi-residential buildings commonly built between ~1860s and 1930s, with the ground level in stone or brick and two levels in wooden construction and wooden façade. In the 1970s and 80s, many *Landshövdingehus* were exteriorly insulated through national energy saving programmes and new façades, often in corrugated metal or composite board materials, were added.

The buildings are not listed but granted a general protection by the Swedish Planning and Building Act (PBL) [5]. PBL requires that all changes made to existing buildings, regardless their age, should be carried out with respect to their character defined by e.g. proportions, form, volumes, materials, detailing, and colours. Furthermore, the buildings are mentioned in the local Protection programme for historic buildings and should be protected as part of an urban environment, and area A as part of the social housing history [6].

1.2.2 Description of the buildings and their renovations

Area A, built in the late 1930s as homes for families with many children, is municipally owned rented apartments (Figure 1). In 1979, the wooden façades of blocks A1 and A2 were covered with boards without added insulation. Block A1 has recently been re-renovated and block A2 is to be renovated with a similar concept (Figure 1b-c). In the re-renovation the panel boards were removed, the wall was insulated on the outside, and a new wooden façade was recreated. The windows were changed and moved to be aligned with the new outer level of the façade, the attic was insulated on the outside and a new roof was created. The original façade was plain and chrome green, the new is yellow and with lock-lists. The original outgoing side hinged windows were replaced by pivot hinged with a false mullion (Figure 1b and d). The calculated energy use decreased from 154 to 93 kWh/m² and year after the renovation.

The façade on A3 differed originally from A1 and A2 (Figure 1d) and was never changed. In the latest renovation, the attic was insulated on the inside and all windows were replaced by the same as in block A1. The measured energy use decreased from 182 to 130 kWh/m²/year.



Figure 1a-d. Case A, a) In 1940s, block A1 (right in picture), block A2 (left), and block A3 (further in the right back), (photo from the web); b) Block A1 in 2017 after the re-renovation, c) Block A2 in 2017 with the panel boards put up in 1979, d) Block A3 in 2017. Photos b, c and d by the authors.

Case B was originally built in the 1890s (Figure 2). In 1915, the block was extended with a few more apartments. In the 1970s, the upper floors were insulated and fitted with a new façade in orange corrugated metal. Around 2005, the block was bought by a developer that initiated a major renovation where the original apartments were altered and new apartments were created in the attic. The metal façade was removed, 50 mm of insulation was added and a new wooden façade was recreated. The outgoing side hinged windows were replaced by larger side hinged windows with a false mullion. The result was an energy use of 135 kWh/m² and year. No figures are available on the energy use prior the renovation. No changes were made to the courtyard façade which is still covered in metal sheets. The developer sold the block to the residents in 2011, who formed a housing association, but two of them wished to remain tenants.



Figure 2. Case B, a) in 1890s (Photo: Gothenburg City Museum), b) before the re-renovation (Photo: www.yimby.se), and c) in 2017 (Photo by the authors).

1.3 METHODS

A mixed method approach was applied, collecting data through a questionnaire survey directed to all residents in both Case areas and by qualitative interviews with nine residents who were identified through the questionnaire. Using two different data collection methods not only provided us with complementary information but also gave us a possibility to compare the methods in themselves and a way to study tenants' interpretation of heritage values.

The questionnaire was sent out in April – September 2017 (paper format) to all households with one reminder. The total response rate was 47 % (table 2). The questionnaire covered demographic data, general satisfaction with the home, experiences from the renovation (not asked for A2), satisfaction with the renovation results, residents' view on heritage, appreciation of building details with relevance for heritage, and perceived raised attractiveness of the home after the re-renovation. Semi-structured interviews, table 3, were carried out in February 2018 using an interview guide that covered the same areas as the questionnaire with a focus on individual interpretation of culture values and how this is expressed. In area A, four of the six interviewees live in block A2 that is still to be renovated. The interviews were recorded and transcribed.

Table 2. Respondents of questionnaire

CASE AREA	NUMBER OF HOUSEHOLDS	NUMBER OF RESPONSES	RESPONSE RATE [%]
A1	36	17	47
A2	108	51	47
A3	12	5	42
B	22	10	45
ALL	178	83	47

Table 3. Interview persons (IP) and household data

IP- CASE AREA	PERSONS IN HOUSEHOLD [N]	AGE IP	MOVED TO THE AREA [YEAR]
IP1-B	1	50-60	1980
IP2-B	2	30-40	2014
IP3-B	2	20-30	2014
IP4-A2	1	60-70	1971
IP5-A2	1	60-70	1992
IP6-A2	1	20-30	2012
IP7-A2	1	70-80	1998
IP8-A3	1	60-70	1988
IP9-A1	1	80-90	1937

2. RESULTS

A majority of the respondents of the questionnaire are female with an average age of 48 years for case area A and 33 years for area B. This can reflect that many inhabitants in area A have lived there for a long time, but also that it in Sweden it is easier for younger households to buy an apartment (as in B) than to find a rental (as in A). Both cases have smaller apartments and most respondents are single person households. More than 50 % have a university level education, which is higher than the average of 31 % in Gothenburg [7]. Among the responding households there are only 20 children. In Case A, originally attributed to families with a minimum of three children, the small apartments (< 50 sqm) no longer seem functional for families. About 80 % of the respondents have Swedish as primary language.

The satisfaction with the living area, is reflected in both the questionnaire and the interviews. Area A is calm and close to services and nature. Area B is located close to services and public transport. The most satisfied residents are found in block A2 which is still to be renovated, but the correlation is still to be analysed. The living costs are reasonable in both areas and a primary cause for relocation in both areas would be to get a larger apartment. Complaints are made of draught, disturbing noise and lack of qualitative outdoor areas.

2.1 APPRECIATION OF HERITAGE VALUES

The respondents of the questionnaire were asked to value the heritage of their own building. In area A, most respondents ticked 3 or 4 on a 5-point Likert scale where 1 indicated very low and 5 indicated very high. In Case B, the respondents indicated a higher appreciation with an average of 4.5. Between 15 % (area A) and 20 % (area B) had no opinion. A follow-up question regarded to what degree they thought that alterations of the building should be made carefully to heritage values (Figure 3). This question also seems to indicate that residents in area B find respect to heritage values important.

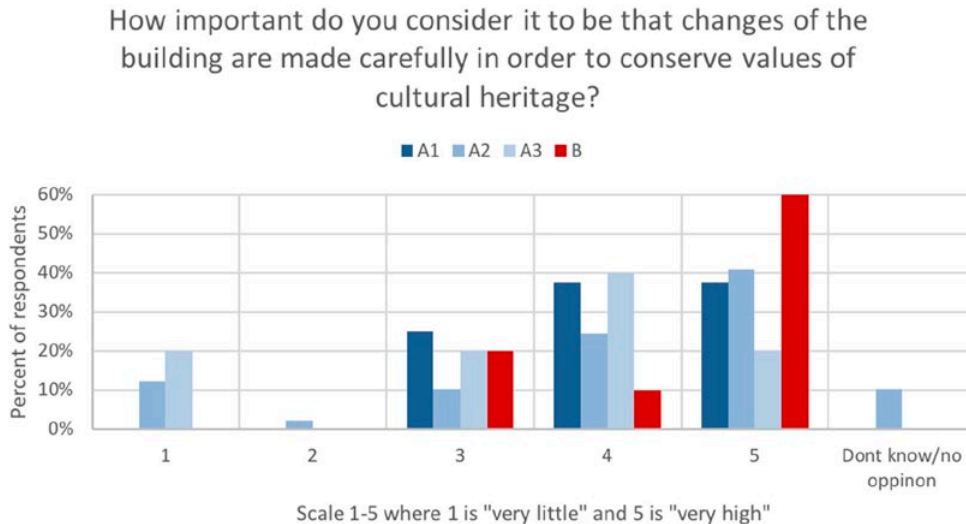

Figure 3. Result from questionnaire, to what degree heritage values should be respected in a renovation.

The interviews provided a complementary perspective. All interviewees in area A had made research about the area and took pride in the history even if most of them had not made an active choice to live in the area or the particular building. Most of interviewees in area A are more than 60 years of age and have lived there for a longer period. Interviewee IP4-A2 says (translated from Swedish):

It is the soul of the area. I am searching for the soul. The soul of the buildings, the soul in the history. //...// It is important to know about the context and you get affected by the history of your area. //...// Otherwise you're a stranger.

Area B is populated by younger people, who moved there only 4–5 years ago. However, two of the young interviewees in area B showed a relation and appreciation to the history and the heritage the building represents, as expressed by IP2-B:

It is enjoyable and exiting to live somewhere that has a bit of a soul and where you can see the traces and feel that this has been something else.

All interviewees say that they find it important that heritage values are considered when renovating. Interviewee IP2-B is a bit disappointed by how the developer has carried out the re-renovation. Now, when maintaining the building, they

perceive that the developer had focus on simple and cheap solutions, and for example the inner façade is still clad in metal.

Although the interviewees reflect an interest in history and heritage, looking at the whole sample of tenants (i.e. 73 of the respondents), there is a higher willingness to pay for indoor climate and environmental profile than for heritage values (Figure 4). From the comments in the questionnaire it can be understood that the tenants in A2 for example think that re-creating the façade is not something the tenants should pay for, this should be part of the maintenance.

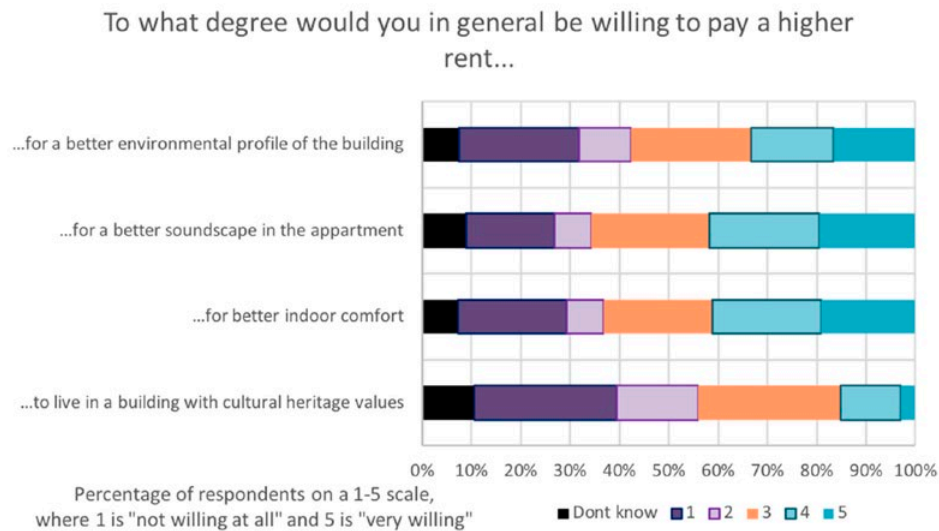

Figure 4. Willingness to pay for different qualities, question only answered by tenants in the questionnaire.

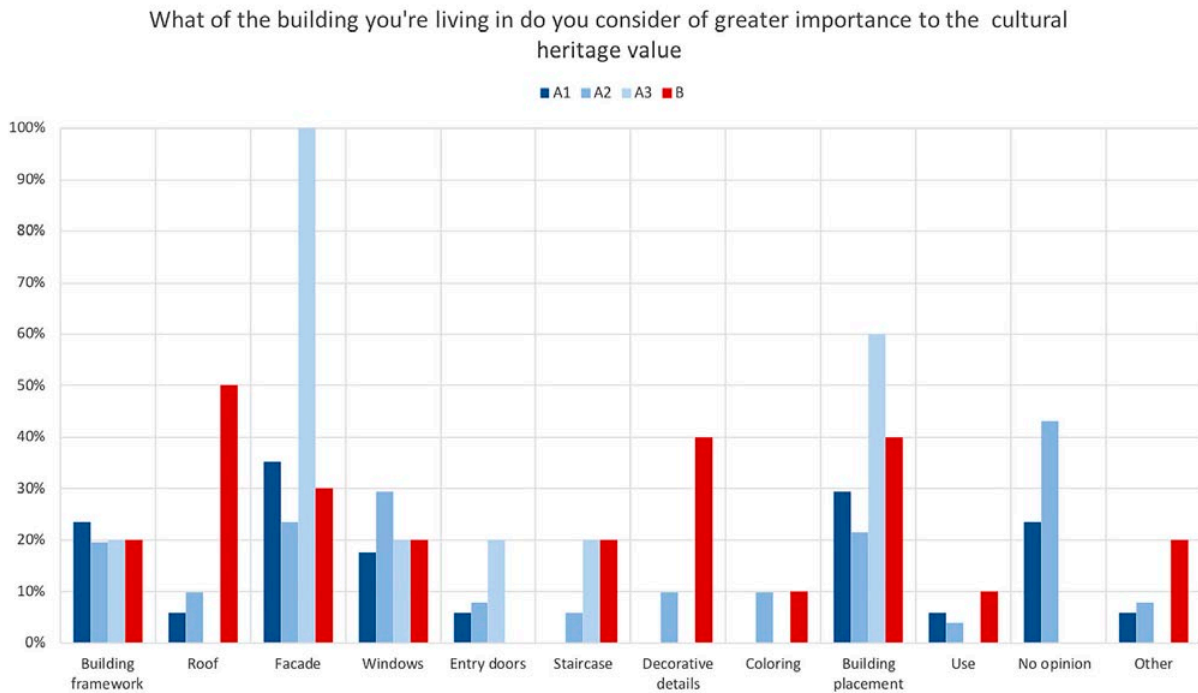

Figure 5. Appreciation of different external elements.

2.2 APPRECIATED ELEMENTS OF THE BUILDING

Asking for the most appreciated exterior elements of the building and the neighbourhood, the questionnaire showed a preference for the façade (area A) and the buildings placement in the urban landscape (area A and B) (Figure 5).

In area B, the slate roof and details are highly appreciated. There is a higher appreciation of the windows in A2, the only block with original windows. Tenants in A3 appreciate their façade, the only original façade in the study. Tenants in A1 appreciate their façade higher than tenants in A2 which still have the board panels.

Both the respondents and the interviewees point out some problems connected to older buildings e.g. high thresholds, lack of a kitchen fan, small bathrooms and draught. At the same time, many of the interviewees pointed to skewed parts and other traces of history as being of particular value to them, giving the building its charm and characteristics.

The replacement of the older windows with new pivot hinged with a false mullion evoke strong feelings among residents in A2 but is not mentioned by any of the respondents in A1 or A3, where these new windows have been installed. Interviewee IP5-A2 even expressed an urge to move if the kind of windows used in the re-renovation of block A1 would be installed in A2 (translated from Swedish):

//...and at the time I thought, if they switch to those kind of windows, I will have to move, because I can't live with those kinds of windows.

The older interviewees in area A value keeping the original windows higher than having an improved indoor climate and less draught from new windows. The younger interviewee IP6-A2 is the only one of the interviewees that think that a higher indoor temperature and a higher environmental profile of the building is a priority to keeping the original window.

3. DISCUSSION

Our interpretation from the results is that residents in historic multi-residential buildings do value the heritage and history of their living environment, and this is valid for both tenants and owner-occupiers. They appreciate that the buildings have a history. This gives a soul to their living environment and a sense of belonging. The results are in line with earlier studies that state that heritage provides people a means to orientate and relate to modern society [1].

The residents point to the façade, the roof and the building in the urban landscape as important external elements. On the inside, doors, details around doors and windows and if there is stucco is important. Flaws and irregularities are in themselves part of the charm and the value, working as physical traces of a past history.

With respect to tenants, of which 71 live in area A and 2 in area B, the interviews indicate a higher appreciation for heritage and history than the results from the questionnaire. This could indicate that it was difficult for the respondents to understand what was asked for in the questionnaire, while in a face-to-face

meeting it is easier to explain what we mean by heritage. However, this could also be a bias of those respondents that accepted to be interviewed where we have a predominance of older residents and maybe with a higher interest in the issue.

The question of willingness to pay for heritage values is delicate. For owner-occupiers, there is a driver as heritage can be linked to higher property values [4]. While earlier studies have claimed that at least companies are willing to pay higher rents for heritage buildings [4], the situation is likely to be different for tenants of housing. The respondents in the questionnaire indicate a lower interest to pay a higher rent for living in a heritage building. When asked about the issue, some of the interviewees in A2 stated that even though they value heritage they do not want a rent increase. Residents in block A1 have had a minor rent-increase (25 €/month) for the re-renovated façade but also for a better indoor climate provided by the new windows.

The study indicates that some interviewees but also respondents of the questionnaire value the old windows and an uninsulated façade much higher than having a better indoor climate. The beauty and history of the windows and the attachment to the older building is more important than comfort and energy saving. Similar judgements have been observed in other studies where the sense of belonging and attachment to older structures [2] or even economic benefits [3] were valued over comfort from renovation. Our study as well as a few earlier [2] indicate that older residents and those having lived longer in an area are more prone to have this attitude. The attitude of valuing existing structures or elements over a new, could also be more prominent among those who live in a building prior to a renovation, or at least be pronounced with a higher certitude before the renovation.

4. CONCLUSIONS

The value of heritage and historic buildings and structures expressed by the residents in our study show a way forward for implementation of the concept of re-renovation in both owner-occupied and rented multi-residential buildings. For the rented apartments, the connection to better comfort and environmental profile could be a way forward to get the acceptance from some of the tenants. The large value that historic building elements represent for parts of the tenants indicates the need to search for better replacement components, not least windows or even solutions where the older building parts are copied or improved for better function. In the continued research, further analysis of the empirical material will provide more insights of correlations between value of heritage and categories of residents.

From a methodological point of view, the study points to challenges when addressing residents with a question concerning heritage. Our study indicates how important it is with a definition of what cultural heritage values are or could be. It could be discussed whether providing examples, images or a glossary together with a questionnaire survey could be a way forward. Another observation is that the distinction between “beautiful” and “heritage” is not always easy for those not trained in the heritage field.

Regarding validity of the results, while the questionnaire had a high response rate we have no possibility to check the representativeness of the respondents to the whole sample. Among both the respondents and the interviewees have a high representation of older residents. The research is still on-going, more empirical material can be added and further analysis of the results are planned.

5. REFERENCES

- [1] Riksantikvarieämbetet. Räkna med kulturarvet: Kulturarvets bidrag till en hållbar samhällsutveckling. Karlskrona. 2017 pp. 1–29.
- [2] P. Femenías, Effekter av renovering och bostadsförnyelse: En översikt över tidigare utvärderingar. SIREn rapport 2015:2, Chalmers tekniska högskola 2015.
- [3] M Sunikka-Blank, R Galvin “Irrational homeowners? How aesthetics and heritage values influence thermal retrofit decisions in the United Kingdom”, *Energy Research & Social Science* 11, 2016, pp 97–108.
- [4] C. Gustafsson. Kreativa kraftfält i Halland. Slutrapport. Kulturmiljö Halland, 2013, pp 42–44.
- [5] Plan och bygglag 2010:900. Svensk författningssamling. Stockholm. Näringsdepartementet. 2010.
- [6] Göteborgs Stadsmuseum. Kulturhistoriskt värdefull bebyggelse i Göteborg. Ett program för bevarande. 1999.
- [7] Göteborgs statistik, <http://statsistikdatabas.goteborg.se/Demografi/>. Accessed 10 March 2018.

Benign changes and building maintenance as a sustainable strategy for refurbishment of historic (Pre-1919) English dwellings

J. Ritson

UCEM, Reading UK. Email: j.ritson@ucem.ac.uk

Abstract – The need to reduce carbon emissions and lower energy consumption of the historic built environment is now being recognised as a critical factor in helping the UK Government’s aim to reduce carbon emissions by 80 percent (compared to 1990 values). This paper proposes that the most sustainable option is to adopt a building conservation focused strategy to maintain and apply small benign changes to the property, rather than encourage historic homeowners to sustainably refurbish their properties. The hypothesis is tested with three approaches: existing datasets, computer modelling and case studies. The results show that through maintenance and benign changes to a historic property, significant energy and carbon savings can be made without affecting the visual or fabric heritage of the property. The study will go on to show that it is also the most economically effective method for sustainably refurbishing historic dwellings.

Keywords – sustainable refurbishment; maintenance; historic dwellings; sustainable strategy

1. INTRODUCTION

This paper proposes a holistic approach to sustainability concerning the historic built environment. It is a strategy based upon conservation principles rather than environmental focused sustainability improvements. It will show that these small benign interventions can have a substantial impact in reducing the energy consumption and carbon emissions within historic built environment. While it has been shown that a Victorian residential property can be improved to zero carbon efficiency, the improvement and refurbishment were economically expensive and damaging to the intrinsic heritage of the building fabric. By taking a more holistic approach and applying maintenance and small benign changes that could be applied to all historic dwellings, this study shows that significant energy and carbon savings can be made to the UK’s historic residential built environment. It will show that these improvements are economically, culturally and environmentally viable and will allow for adaptation in the uncertain future that the existing residential stock faces.

2. CONTEXT

There are over 4.7 million of pre-1919 dwellings in England, this equates to over 325 home refurbishments every single day from now until 2050, if the carbon reduction and other sustainable goals are to be met. The pre-1919 housing stock in the UK has, on average, the worst Energy Performance Certificate SAP (EPC)

score and the highest carbon emission of any house age group, and typically, over twice the maintenance costs compared with modern housing for basic repairs. However, they usually have a higher market value because their intrinsic heritage is valued by potential purchasers. [1].

The interpretation of the sustainable, triple bottom line is key to understanding the context of this study. For a project to be sustainable in this context, it should meet the requirements of environmental factors, respect the heritage of the dwelling's cultural importance and fall within the financial capabilities of the dwelling owners. It is also to be recognised that while this study is focusing on energy consumption, there are many other factors that need to be taken into account across all three categories of the sustainable triple bottom line, such as waste production, water usage, upfront costs, changes in lifestyle, impact on house value, and, planning guidance, etc. Dwellings are perhaps the most heterogeneous of all of building stock. They are one of the most continually updated and adapted building types. Different people have different levels of comfort in terms of heating, and similar dwellings may have very different lifestyle occupancy and usage. Each set of owners of a dwelling make their own changes to the property, so therefore the properties that may have originally been built to the same design, are in fact unique as a consequence of these various updates and alterations. This continual adaptation allows for houses to accommodate changes in lifestyle which, in turn, allows the building to remain a viable dwelling. It could be argued that because the dwellings that have survived decades and centuries are actually within themselves inherently sustainable and adaptable assets because of their continued successful use. This is recognised by national conservation and heritage bodies as defining building conservation as the management of change rather than simply the preservation of a heritage asset [2].

3. PROJECT AIMS

The project hypothesis is '*The most sustainable strategy for owners of historic Suburban housing does not lie in sustainable focused refurbishment of their dwellings but in historic building maintenance and benign improvements.*' The overall aim of the project is to show that by maintaining buildings, and with carefully selected interventions, the improvement in the environmental performance of historic dwellings could be significant, and at the same time be economically viable and culturally beneficial to the preservation of the historic asset.

4. HISTORIC BUILDING MAINTENANCE AND BENIGN CHANGES

It is important to understand that the fabric and the appearance of a historic dwelling have cultural significance—the building itself is an artefact and historical asset. Preventative maintenance is internationally recognised and has been central to building conservation legislation and charters [3]. Building maintenance and conservation plans are an accepted part of building conservation work. However, they are rarely carried out on historic dwellings. In fact, it is much more common for reactive repair to be implemented, rather than preventive maintenance [4].

It is important to emphasise that the terms ‘maintenance and repair’ should not be seen as interchangeable as they might be for other building types. This is because no matter how well-considered the repair is, it will involve some form of damage, removal or replacement of the historic fabric [5]. Maintenance is important in protecting cultural significance because correct maintenance is the least destructive of all the interventions which take place in the process of conserving the historic built environment. The idea of approaching work from a minimum intervention methodology is best summarised by the Burra Charter [6] “as much as necessary, as little as possible”. The methodology for this study is the improvement in energy saving and carbon reduction with as little damage or change to the inherent heritage of the historic dwelling.

The Historic Town Forum [7] supports this methodology stating that ‘One of the most energy efficient ways to preserve historic buildings is to ensure that continued, regular maintenance is carried out to safeguard its historic fabric.’ Both the Historic Town Forum and English Heritage encourage the use of small/benign changes to improve the environmental performance of a historic dwelling. This paper defines benign changes as interventions that either have little or no effect on the heritage of the dwelling, do not damage the dwelling fabric, or the way the fabric needs to perform or react.

5. METHODOLOGY

The study uses three main sources of information to collect its required information. The first was a series of existing datasets that were available, which showed the energy efficiency improvements of various interventions on properties. This included large statistical databases such as the English House Condition Survey, as well as various case study datasets. Many of the existing data sets and case-studies used to provide relevant information, were focused on over-ambitious carbon and energy savings. The individual interventions were further analysed to determine if they would have an impact on the fabric and visual heritage of the dwelling. Only interventions that had low impact on fabric and visual heritage were categorised as benign changes. The data points were created to form a database of interventions comparing reduction of energy savings to cost of the intervention. Overall trends and findings are summarised in table 1 and figure 2. The second set of information was collected via computer modelling. The modelling package used in this study was NHER, which is a static modelling package. It is approved by the UK Government to provide energy performance certificates and ratings (SAP) for residential buildings [8]. It is worth noting that the UK Government currently only allows certain static modelling packages to be used in the residential energy assessment process and while the NHER package does have limited dynamic features such as occupancy rate and limited usage modelling, it is allowed [9]. The third set was from a live case study building, where actual energy savings were recorded as the specified improvements were applied to a historic Victorian dwelling.

6. SUSTAINABILITY

6.1 OVERALL SUSTAINABILITY

While the term sustainability is now in common use, it is more often applied to mean environmental factors rather than the holistic triple bottom line. This triple bottom line, taking into account environmental, social/cultural and economic factors, is key when dealing with historic built environment. Any sustainability strategy that applies to the historic built environment needs to take into account the cultural importance of the assets being considered, which in this paper is the historic dwellings within the UK. The historic built environment has a both a valued, tangible and intangible heritage which is often linked to the fabric and the appearance of a building. This needs to be considered while the overarching urgency to reduce carbon emissions and increase energy efficiency is also undertaken. The final criteria of the triple bottom line are economics; any scheme proposed for holistic application across the historic built environment has to be viable economically, not just a study in what is technically possible. This understanding of the holistic approach to the triple bottom line of sustainability has often been lacking in past sustainability strategies. This, along with a lack of understanding of the technical requirements that apply to historic buildings and their fabric, has often meant that, at best, sustainable refurbishment practices have been ineffective and, at worst, they have been extremely damaging to the fabric and appearance of the valued historic built environment.

6.2 CULTURAL BENEFITS

The main cultural benefit of a maintenance strategy is the improvement of the historic preservation of the building. Maintenance retains historic fabric because less material is lost in regular, minimal and small-scale work than in disruptive and extensive restoration [10]. The survival of any building is underpinned by regular and continued maintenance [11], but other than historic churches there is no current UK legislative driver for the enforcement of maintenance of historic buildings [12]. Preventive maintenance can help reduce the need for both damaging and expensive repairs and prolong the life of the existing historic fabric. Large-scale studies by English Heritage [13] have shown that the general UK population value the cultural importance of historic buildings.

6.3 ECONOMIC BENEFITS

Financing has long been seen as a barrier to widespread integration of sustainable changes into the existing built environment. While many of the studies reviewed [14] have focused on meeting the target of 80 percent reduction in carbon reductions, the over-focus on this figure has meant that some refurbishments become too expensive to be rolled out nationally, expecting all owners of historic dwellings to apply these to their houses by 2050. This paper focuses on what has come to be called the low hanging fruit—the easy, low cost interventions or the type of intervention that would happen through periodic renewal.

Any sustainability policy has to meet the financial and economic constraints of the affected parties. Thus, any proposed strategy in dealing with the historic built

environment has to not only be successful in lowering carbon emissions but also has to be financially attractive to the participants who are going to be involved in implementing any such strategy. The three main economic factors that concern historic dwelling owners are (a) the value of their property; (b) the maintenance and repair costs of the property, and; (c) the cost of current and future energy bills for that property. It is also believed by the owners of historic dwellings that EPC certificates have little or no impact on the re-sale financial value of their properties [15]. This section will show how long-term preventative maintenance strategies and benign environmental improvements to the historic dwellings can help meet these requirements. Some of the other environmentally focused refurbishment strategies are typically of a much higher cost. An example of this can be seen in a typical EPC recommended improvement, costs around £ 15,000 [16]

The cost of any periodic professional inspection to historic buildings has to be added to any financial calculation in considering the economic impact of this strategy. The work by Forster & Kayan [17] has shown that the costs of such inspections are more than covered by the savings of preventing expensive unnecessary repairs through the use of preventative maintenance strategies. In figure 1 (adapted from Forster & Kayan, [18]) it is shown that over a period of time, preventative maintenance along with the cost of periodic inspection actually reduces the overall repair costs of historic dwellings. The costs shown in Figure 1 have been averaged out over time (in a linear fashion), rather than shown at time of expenditure to allow for comparative analysis. The costs include both maintenance and repair costs plus the cost of inspection, are shown averaged

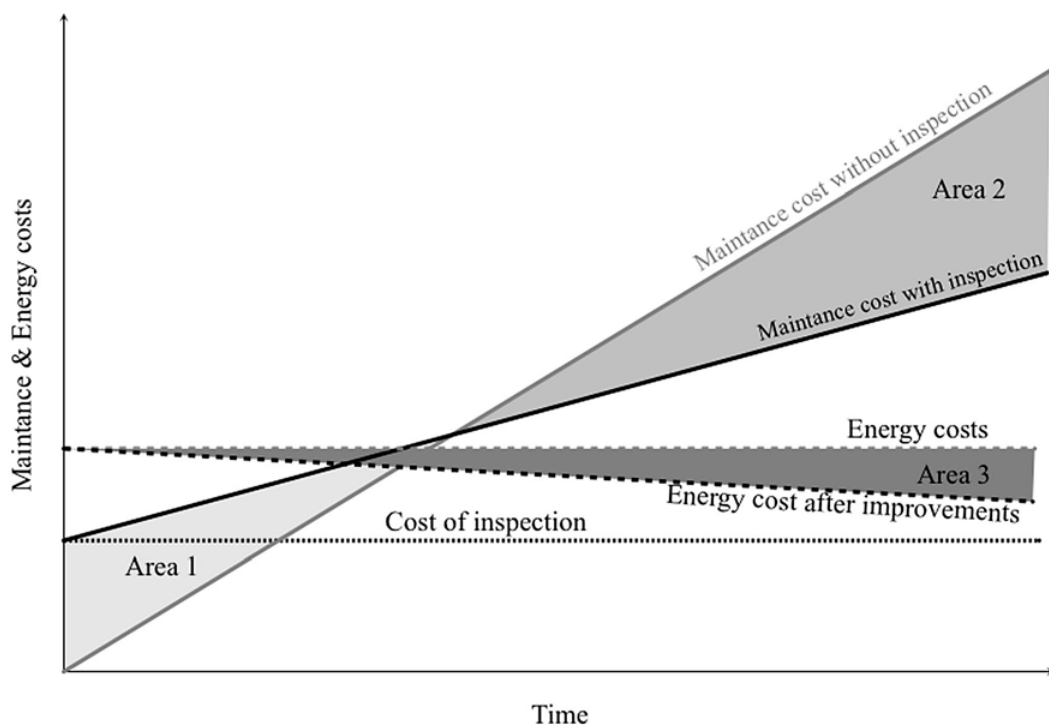

Figure 1. Maintenance costs with and without professional inspection compared over time.

out between inspection periods. Figure 1 shows that as long as Area 2 is larger than Area 1 there is an economic saving on the use of preventative maintenance schedules identified through periodic professional inspection. Further financial benefit is identified through the energy savings that come from the benign changes of the environmental performance of the building. Area 3 shows additionally the reduced energy costs from the benign environmental improvements. Additionally, area 3 can be seen as a further cost incentive for professional inspection incorporating preventative maintenance and benign changes.

The English House Condition Survey [19] indicates that essential repair costs for historic dwellings are more than twice that in modern dwellings. This again further highlights the economic benefits of continued professional inspection and preventative maintenance to secure the financial sustainability of historic dwellings. There are wider economic benefits of the strategy, as small-scale maintenance and repair work is often carried out by local tradesmen there is a further economic benefit to the local economy in encouraging more maintenance work to historic dwellings [20]. Although difficult to quantify, the improved condition increases the resale value of historic dwellings and this is in addition the higher market value of historic and traditional housing compared to the modern equivalent dwelling. Therefore, the economic benefit of preventative maintenance can also be seen by the increase in the market value of the property.

6.4 ENVIRONMENTAL BENEFITS

The environmental benefits of benign changes are one of the key foci of this study. The modelling cannot take into account behavioural changes and other specific factors that may affect the energy use and carbon emissions from an individual dwelling. Considerable energy savings can be made simply through behavioural changes and through small but gradual lifestyle changes. Examples of these changes are turning off lights in rooms when not in use or wearing warm clothes inside and turning the heating thermostat down. It is accepted that in many cases this may not be a viable option particularly for elderly or very young occupants, but it reinforces the importance of behavioural changes in reducing carbon emissions and energy consumption in historic dwellings.

The term benign changes can be divided in to two main groups. The first being periodical interventions, typified by upgraded replacements, an example may be an old boiler being replaced by a new high efficiency condensing boiler or the replacement of a kitchen appliance such as fridge. The second type of benign change is the active intervention, which is when a small change is made to the building to help improve the energy performance of the historic dwelling: an example of this would be the fitting of draft excluders around openings or the replacement of roof insulation. These changes are defined as benign changes as they have little or no effect on the fabric or visual heritage of the building. Benign changes typically are cheaper and more 'light touch' than more focused environmental improvements. The benign changes looked at in this study do not exclude future, more typical, environmental improvements to be made to the building.

7. KEY FINDINGS FROM THE STUDY

The aim of the study was to find cost effective interventions that would improve the environmental performance of historic dwellings at the same time have little or no impact on either the visual or fabric heritage of the building.

Table 1 provides an overview of the key interventions that were found to meet these criteria within the study. The study showed that by making sure that the heating system, with up-to-date controls, is the most efficient, significant savings can be made with little or no effect on the heritage values of the building. Other interventions such as draught-proofing and roof insulation also had a positive impact on reducing the energy consumption and carbon emissions of historic dwellings. The results clearly show that savings in the area of 30 to 40 percent are easily achievable in historic dwellings without the need to damage or impact the fabric of the building significantly.

Table 1. Summary of the overall study's results

Action	Percentage Energy Saved %		Capital Cost Used in Study (£)	Impact on Fabric Heritage	Impact on Visual Heritage
Upgrading the loft insulation to 300 mm	4.0%	31.1%	£273.00	LOW	LOW
Draft proofing and window repair	2.0%	10.0%	£50-£2000	LOW	LOW
Hot water cylinder insulation to >75 mm	3.6%	8.7%	£20.00	LOW	LOW
Fitting of a condensing boiler	16.0%	46.0%	£1,750.00	LOW	LOW
Improved heating controls	12.0%	14.1%	£250.00	LOW	LOW
Energy saving light bulbs	0.1%	0.2%	£200.00	LOW	LOW
Floor insulation fitted in raised timber floor	8.3%	14.0%	£1,000.00	LOW	LOW

When all of the interventions of the various buildings were tabulated and graphed, they all followed a similar trend as shown in Figure 2. It indicates that there were many interventions in the shaded area that were low in cost but had a significant impact on the environmental performance of the dwelling. What the study clearly shows is that there is a rate of diminishing returns higher up the carbon emissions and energy usage. And while under £ 5,000 it is possible to achieve energy savings of around 30 to 40 percent (more with behavioural changes). Above this it becomes increasingly expensive and also more damaging to the visual and fabric heritage of the building. It is the conclusion of this study that the interventions that fall into the shaded category of the chart should be the main priority of any policy rather than the more expensive environmentally focused, typical sustainability interventions. The key findings from the study are that the hot water and heating system are the key elements that need to be the focus of energy conservation in historic dwellings. Many of the dwellings surveyed had old boilers and heating

distribution systems and if replaced with a modern condensing boiler, significant savings in both carbon emissions and energy consumption could be made.

It should also be noted that while this proposal successfully meets the triple bottom line sustainability criteria as set out in the study, it does fall short of the overall aim of an 80 percent reduction in carbon emissions (compared to the 1990 values). Further interventions or wider environmental improvements such as 'greening' of the National Grid would be needed if further improvements are to be achieved.

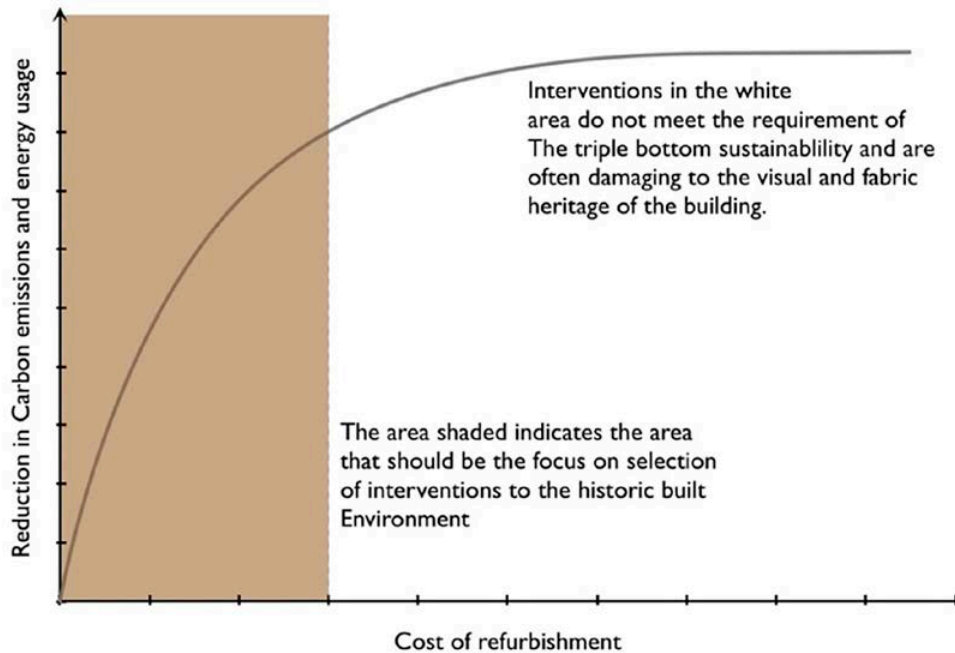

Figure 2. A comparison of cost to energy saving for all the interventions in the study.

8. REFERENCES

- [1] EHCS, English House Condition Survey 2007, Annual Report, London: Communities and Local Government. 2009.
- [2] English Heritage, Conservation Principles, Policies and Guidance, London: English Heritage. 2008.
- [3] Forster, A.M. & Kayan, B. Maintenance for Historic Buildings: a current perspective, *Structural Survey* Vol. 27 No.3, 210–229, 2009.
- [4] Forster, A.M. & Kayan, B. Maintenance for Historic Buildings: a current perspective, *Structural Survey* Vol. 27 No.3, 210–229, 2009.
- [5] Dann, N. & Worthing, D. Heritage organisations and condition surveys, *Structural Survey* Vol. 23 No.2, 91–100, 2005.
- [6] ICOMOS. Australia ICOMOS Charter for Places of cultural significance (The Burra Charter 1999). Paris: International Council on monuments and sites. 1999.

- [7] HTF. *Saving Energy: A Guide for owners of Historic Homes*, Bristol: Historic Town Forum. 2011.
- [8] NES. What is an NHER rating? [Online] Available at <http://www.nesltd.co.uk/blog/what-nher-rating> 2012 [accessed on 20-02-12]
- [9] Bothwell, K., Sach, M & Mallion, P. Retrofit of existing housing in the United Kingdom: the carbon reduction possibilities. *Architecture and Sustainable Development*. Proceedings of PLEA 2011, Louvain-La-Neuve Belgium (July 2011).
- [10] Kindred, B. Maintaining value through Maintenance, *Context: IHBC* 85 July 2004, 21–22, 2004.
- [11] Forster, A.M. & Kayan, B. Maintenance for Historic Buildings: a current perspective, *Structural Survey* Vol. 27 No.3, 210–229, 2009.
- [12] Dann, N. & Wood, S. Tensions and omissions in maintenance management advice for historic buildings, *Structural Survey* Vol. 22 No.3, 138–147, 2004.
- [13] English Heritage. *Valuing our Heritage*, London: English Heritage. 2007.
- [14] Yates, T *Sustainable refurbishment of Victorian housing Guidance, assessment method and case studies*, Watford: BRE trust, 2006.
- [15] Husle, T. Achieving Zero Carbon in Conservation Areas, *Green Building* Winter 2011, 52–55, 2011.
- [16] English Housing Survey Potential Stock improvements 2015 London: Department for Communities and Local Government, 2017.
- [17] Forster, A.M. & Kayan, B. Maintenance for Historic Buildings: a current perspective, *Structural Survey* Vol. 27 No.3 210–229 2009.
- [18] Forster, A.M. & Kayan, B. Maintenance for Historic Buildings: a current perspective, *Structural Survey* Vol. 27 No.3 210–229 2009.
- [19] EHCS, *English House Condition Survey 2007, Annual Report*, London: Communities and Local Government. 2009.
- [20] Dann, N. Owners Attitudes to Maintenance, *Context: IHBC* 84 March 2004, 14–16, 2004.

What's behind the façade?

A long-term assessment of the Swedish energy efficiency programme 1977–1984 and its impact on built heritage

G. Leijonhufvud, M. Tunefalk and M. Legné

*Conservation Unit, Department of Art History, Uppsala University – Campus Gotland, Visby, Sweden.
Email: gustaf.leijonhufvud@konstvet.uu.se; mattias.legner@konstvet.uu.se;
martin.tunefalk@konstvet.uu.se*

Abstract – Energy efficiency policies might have a negative impact on the heritage values of buildings, an issue widely recognized in Sweden during and after the extensive energy efficiency programme ‘Energy savings plan for existing buildings’ (EBB 1977–84). The purpose of this paper is to assess the long-term impact of the EBB on an urban district in Gävle, Sweden. The district comprises 69 single- and multi-family detached houses built between the 1920’s and 1950’s. Using archival sources and field studies we describe how the buildings have been modified and trace the role of the EBB on the district as a whole. The results show that despite that the EBB has had a major impact on the district, it is difficult to disentangle its role in relation to other factors. The study raises concerns over the common approach in policy making to draw distinct lines in the sand between heritage and non-heritage buildings.

Keywords – conservation; historic buildings; energy efficiency policy; program evaluation; energy retrofit

1. INTRODUCTION

To realise the ambitious targets set by the Swedish government on energy efficiency in buildings requires long term, strategic policies [1]. Evaluations of energy efficiency policies tend to focus on a narrow set of techno-economic factors and look at the most recent programme in isolation with the aim to assess its cost-effectiveness [2]. Scholars have therefore asked for evaluations that look at a broader set of effects, which necessarily require contextualization, more comprehensive models and longer time frames [3]. One unintended consequence of energy efficiency policies might be a negative impact on the heritage values of buildings, an issue which was widely recognized in Sweden after the first years of an extensive energy efficiency programme introduced after the first oil crisis of 1973, called the “energy savings plan for existing buildings” (EBB, 1977–84). EBB was the first comprehensive national programme for energy efficiency in buildings in Sweden, but the state subsidised grants on a smaller scale already from 1 July 1974 [4]. In order to improve the energy performance in the building stock, loans and grants were issued through EBB to home owners for measures such as additional thermal insulation, triple glazing windows, more efficient heating systems etc. The EEB and its predecessor has been criticised for resulting in too extensive refurbishments, thus compromising cultural values in the built environment. [5]

The objective of the paper is to assess the long-term impact of the EBB programme on a historic district in Brynäs, located in the city of Gävle, Sweden. This study will put EBB subsidised interventions in relation to additions, renovations and new construction that occurred without EBB support in the period 1974–2017. The aim is twofold. First, it is to more generally contribute to a wider understanding of the changes related to energy efficiency that the built environment in Brynäs has undergone. This is important, as the extent of energy retrofit in the existing building stock is necessary to gauge both for determining energy conservation potential and for designing policies. Second, the aim is to relate the changes in the built environment to the EBB in order to better understand how such energy efficiency policies are played out in legislative and practical context. Policies based on subsidies have continued to play a declining but important role in Swedish policies up until today, despite a lack of strategic evaluation [1].

Considering the limited space available this paper focus on the presentation of results. Further publications from the project aim to involve more theory as well as extend the analysis of the results presented here.

2. THE CASE STUDY

The study is limited to an area of eight blocks in the city district *Brynäs* in Gävle, Sweden. The area comprises 69 single- and multi-family detached houses built between the 1920's and 1950s. Four blocks were constructed in the 1920s, originally as three- or four-family houses, although most of them today are used as single-family houses. One block was built-up in the 1930s, two in the 1940s, and one in the 1940s–1950s (Figure 1). Most of the buildings from the 1930s–1950s were originally two-family houses, today used by one family. The architectural styles of the buildings as well as how they are situated on the plots shifted after the 1930s, resulting in a difference in character between the northern and southern parts of the district. Typical examples of buildings are shown in Figure 1. The area was predominately working class, and the buildings were developed and owned by the residents themselves. The northern part of the area, with buildings from the 1920s and 30s is in the most recent urban development plan described as having very high cultural values, with reference to the garden city-character of the area as well as the architectural qualities of the buildings [6]. There is however no formal designation of the area with reference to cultural heritage values; neither is any of the properties listed.

3. METHOD

The study was carried out in four steps. First, archival studies of the municipal archive of building permits were carried out in order to find original drawings for the buildings, as well as approved exterior alterations. Secondly, we have carried out ocular observations of the current state of the buildings, in order to find out whether approved alterations have actually been carried out, and to detect alterations carried out without consent from the municipality. The third step has been to find out whether alterations made in 1977–1984 were granted support from

the EBB. This was done using the archive of the regional housing committee (*Länsbostadsnämnden*). The committee handled subsidies and loans included in the EBB. By using these methods, the vast majority of exterior modifications can be traced, dated and associated with the EBB.

The fourth and final step consisted of a collective interview that was conducted in order to better understand the development of the area, as well as how this development is perceived today by urban planners and heritage professionals. A conservation officer from the County Administrative Board of Gävleborg, as well as a conservation officer, and an architect from Gävle Municipality, participated in a walking tour of the area. After the tour there was a discussion that was recorded and transcribed. An energy expert from the County Administrative Board participated in this discussion, in addition to the individuals already mentioned.

A survey with the aim to assess the impact of the EBB on the district's heritage values was carried out already in 1979 after the first years of the programme [7]. The area has been re-surveyed in 1984 and 2012 by the County Administrative Board of Gävleborg. The survey and the follow-up work made by the County Administrative Board have been used both as comparison and as valuable sources of information about the area and its changes.



Figure 1. To the left: Map showing the studied area and the different periods when the houses were built. The map is adapted from [7]. Upper right: Architectural drawing for Hackan 9, from 1923. Lower right: Architectural drawing for Bommen 1, from 1943. Source: Gävle kommuns arkiv.

4. RESULTS

In this result section we focus on to what extent windows and façades have been changed, as these are the exterior parts of a building which commonly are changed in energy retrofits. As demonstrated in Figure 2, by the end of the EBB most of the properties in the district had undergone exterior changes, especially in the northern, older part.

Out of a total of 69 properties, 45 (65 %) had new windows and/or façades installed. These new façades were all constructed with additional thermal insulation, most commonly 50 mm of mineral wool. 43 of the properties (62 %) received EBB grants for improved energy efficiency, of which 27 were for exterior measures (63 % of granted funds). Some properties received grants for more than one measure in one or multiple applications. In the district, a total of 56 applications to EEB were accepted.

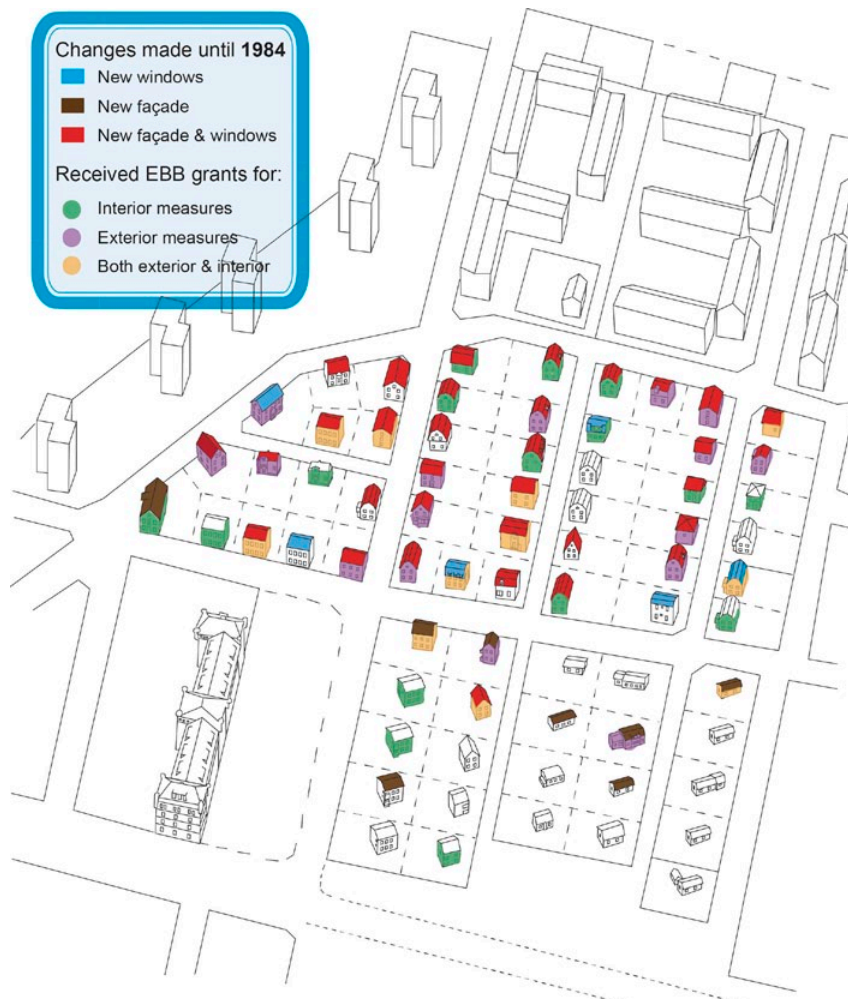

Figure 2. Houses that had undergone exterior retrofitting of windows and façades in 1984. Properties that had received grants from the EBB-programme are shown. Exterior measures can be either more energy-efficient façades or windows, interior measures can be internal wall or loft insulation, improved control (e.g. thermostats), improved or changed heat source (e.g. more efficient boiler or connection to district heating). The map is adapted from [7] and the data from 1979–1984 comes from the County Administrative Board of Gävleborg.

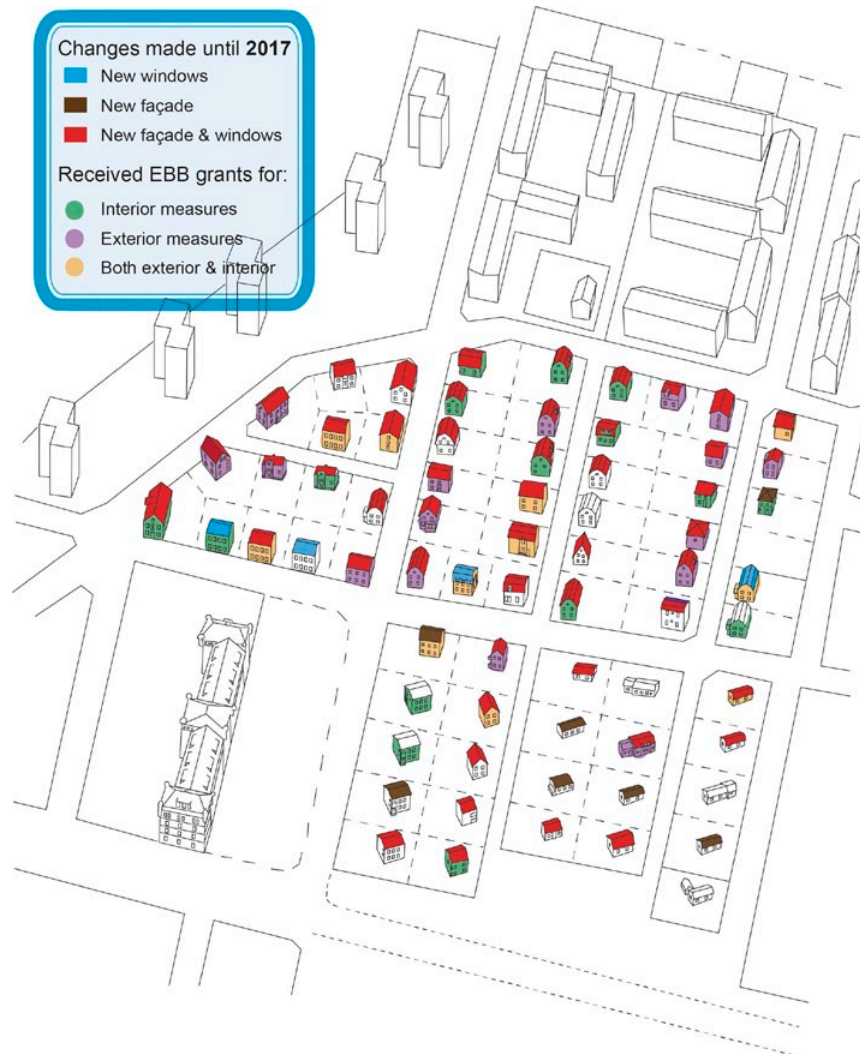

Figure 3. Houses that had undergone exterior retrofitting of windows and façades in 2017. Properties that had received grants from the EBB-programme are shown. The map is adapted from [7].

As demonstrated in Figure 3, alterations to the buildings did not stop with the EBB. Since then, most of the houses unaffected by the programme have been subjected to changes of façades, windows or both. From 1985, 16 additional houses have new windows and/or façades. One house has been demolished. Only seven of the 69 houses still have original windows and façades, only one of the houses from the 1920's. The share of buildings with new windows increased compared to 1984, from 54 % (37 out of 69) to 79 % (54 out of 68), and the number of retrofitted façades increased from 57 % (39 out of 69) to 84 % (57 out of 68).

The graph in Figure 4 summarizes the developments shown on the maps, and it demonstrates clearly that a vast majority of buildings from the 1920s and 1930s, and most from the 1940s and 1950s, had altered windows and façades in 2017. The retrofitting of facades and windows has continued in the area since 1984, although the rate of change has been lower in 1985–2017 than during the EBB.

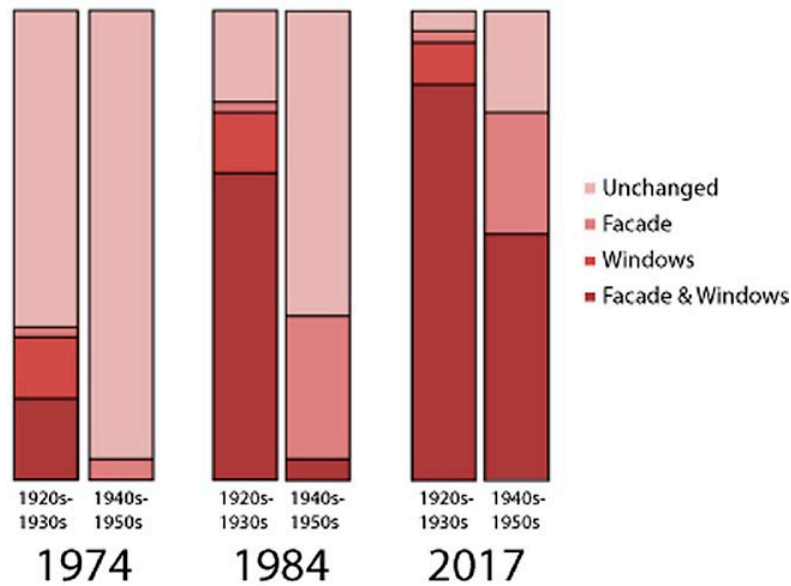

Figure 4. Share of houses that have had retrofitted façades, windows or both before and after the EBB programme 1974–1984 and in 2017. The left columns show houses built in the 1920s and 30s in the quarters Korpen, Spettet, Krattan, Hackan and Spaden (N=46), while the right columns show houses built in the 1940s and 50s in the quarters Bommen, Gaffeln and Røjeln (N=23).

To sum up the development of the area when it comes to exterior energy efficiency measures, one could say that it shows an expected pattern of two waves of renovation activity related to the age of the buildings. What is unexpected is the massive extent of the retrofitting activity in the area. The first wave of renovations was carried out almost exclusively in the older stock of buildings from the 1920's during the period of the EBB. These buildings were by then 50 years or older and in need of modernization. Some of them had undergone major renovations with external insulation and change of windows already before 1974 (Figure 4). EBB seems therefore to have accelerated a renovation movement that was already in force, rather than establishing a new one. The houses from the 1940s–1950s were not in need of major renovations at the time, which is evident in the fact that only one building had its façade changed before 1974. Still, there were some exterior measures carried out during the EBB-period, mainly consisting of exterior insulation covered with metal cladding. However, this area with post war buildings has undergone a second wave of renovation since 1984 and most of the buildings today have new façades and windows.

5. DISCUSSION

The studied area has been subject to continuous change in the last half century. The EBB had a significant impact on the built environment and accelerated the number of major exterior alterations, such as new windows and façades. But despite that the impact of the programme was significant at the time, it is

difficult to disentangle its role in relation to other factors, especially since the rate of alterations was continuously high after the programme had ended. For the individual household there is an array of rationales involved in the decision to renovate, and this decision is made in a fragmented and for the household more or less opaque policy context. It will always remain difficult to determine the impact of a certain policy instrument in such situations.

It is however likely that the EBB continued to exert influence long after it was cancelled. During the group interview, it was discussed whether the area at some point in time had reached a tipping point due to the many alterations made during the EBB. Since the area had been subjected to extensive changes and had lost its original character and uniform style, conservation can be expected to have been given a lower priority also for the individual, and sometimes well preserved, building.

Another issue that was discussed during the group interview was the role of the municipality in relation to the EBB, which was administrated by the state. One conclusion is that the municipality has not used its authority to decline or influence energy efficiency measures. One example is that for the many exterior insulations made during the programme, it was only needed to get consent from the municipality for changes to the surface (i.e. colour, material) and not for the change of construction which had a significant impact on the character of the building.

So far in this paper, we have only focused on *if* a certain measure was carried out or not, not *how*. During the walking tour of the area, and in the following group interview, there was a discussion about the importance of *how* energy efficiency measures had been carried out in relation to what was understood to be the character of the district. There was consensus among the interviewees that most of the exterior alterations made in the district, both during EBB and in recent years, had been unnecessarily intrusive and thus had compromised the cultural and architectural values of the district to an unnecessarily high extent. There was however disagreement about the potential to carry out external retrofits without compromising the character of the building, and about what elements that now remained as character-defining in the area.

Today, the municipality seems to have remained with a *laissez-faire* attitude towards external retrofits in the area. Most likely, they would be more inclined to protect heritage values if the area had more of its original qualities preserved. From a conservation point of view, this is problematic since it risks that areas become left out of discussions of preservation and the built environment being divided between areas having cultural values worth preserving, and others that do not. In recent years, there has been a discussion among policy-makers on whether to include listed buildings in energy efficiency programmes, considering the risk that their cultural values will be compromised. Perhaps it is time to discuss the potential problem of cultural heritage values being neglected in areas that are already heavily affected by exterior alterations? From a conservation point of view, the problem for this area is not that energy efficiency measures

have been carried out. Since the original houses had insufficient insulation and low thermal comfort, it is likely that they would have been neglected or demolished if measures were not taken. The problem is rather that measures have been poorly executed and that they have been too extensive, altering the area's character and subsequently leaving the area neglected by the municipality.

In this paper we have explored the first results of the study, with a focus on quantitative changes. Further publications will contextualize the results and provide a deeper analysis of the development of the district. Comparisons will also be made with other urban districts, not least to better understand the role of the municipalities in relation to the EBB.

6. ACKNOWLEDGEMENTS

The research was funded by the Swedish Energy Agency through the research programme Spara och Bevara. The authors would like to thank the County Administrative Board of Gävleborg for giving us access to their data.

7. REFERENCES

- [1] Kiss, B., McCormick, K., Neij, L., and Mundaca, L. "Policy Instruments for Energy Efficiency in Buildings: Experiences and Lessons from the Nordic Countries." Paper presented at Counting on Energy Programs: It's Why Evaluation Matters, Paris, 2010.
- [2] Vine, E. "Strategies and policies for improving energy efficiency programs: Closing the loop between evaluation and implementation." *Energy Policy* 36, 3872–3881, 2008.
- [3] Mundaca, L., Neij, L., Worrell, E., McNeil, M. "Evaluating Energy Efficiency Policies with Energy-Economy Models." *Annual Review of Environment and Resources* 35, 305–344, 2010.
- [4] *Sammanfattning av bostadsstyrelsens utvärdering av energisparstödet till bostäder budgetåret 1977/78*. Stockholm: Bostadsstyrelsen.
- [5] Antell, O., and Paues, C. *Isolering uppåt väggarna*. Stockholm: Byggeforskningsrådet 1981.
- [6] Gävle kommun. "Kulturmiljöbilaga Gävle stad 2009." Internet: <http://old.gavle.se/Bygga-bo-miljo/Kommunens-planarbete/Oversiktplaner/> [accessed 2018-03-16]
- [7] Länsstyrelsen Gävleborgs Län. (1979-10–25). *Energisparlån och fasadombyggnader. En provstudie av åtta kvarter på Brynäs. PM och utredningar om kulturminnesvård 1979:1*.

Energy efficiency assessment of Indo-Saracenic buildings in India

Ar. S. Choudhary, Dr. S. Pipralia and Dr. N. Kumar

Department of Architecture and Planning, Malviya National Institute of Technology, (MNIT), Jaipur, India. Email: jaysee7@gmail.com; pipralia@gmail.com; nkumar.arch@mnit.ac.in

Abstract – In today's globalized world when the architecture fraternity is posed with dilemmas of making choice between global or regional; green or gadget; economic or trendy; questioning significance of historical structures and their use in the contemporary and the future societies has become even more pertinent. Distinctively, for the third world countries like India where historic architecture forms an integral and important part of the social fabric of the cities, the position and role of these structures need to be re-established. Current national and international imperatives to curb energy use and reduce greenhouse-gas emissions across the world have triggered intensive efforts to formulate guidelines for new and refurbishing existing buildings towards energy efficient construction. Along with a new aesthetic language the Indo-Saracenic architecture also introduced a new building typology of public use buildings like hospitals, state administration offices, educational institutes, theatres, public libraries, museums and town halls to the Indian society. Thus energy performance evaluation of these buildings becomes an intriguing subject of study.

Keywords – Indo-Saracenic, historic public buildings, energy efficiency assessment, living heritage, India

1. INTRODUCTION

India has been host to several cultures of the world since ancient times; all of which have added to the richness of her architectural heritage by suitable amalgamation of styles, adaptations to the local climate, introduction of new building materials, varied display of technical know-how and numerous interpretations of the native craft skills. Along with their own kings and rulers, foreigners like Islamic rulers, the Mughals, Portuguese as well as the British have given mesmerising structures to the country's skyline, amalgamating the local style and adding newer elements to the existent architectural fabric of the place.

An accretive character permeates Indian architecture throughout the recognized periods in history and each period has seen a conscious mixing of styles and the creation of a new hybrid architecture. One such initiative, gave birth to the Indo-Saracenic Architecture style, an eclectic mix of European, Hindu and Mughal building elements. Despite being a symbol of colonialism, the Indo-Saracenic architecture was "modern" and incorporated much of the taste of its time. The style has been an inspiration to a lot of public and administrative architecture of the post independent India.

Along with a new aesthetic language, the Indo-Saracenic architecture also introduced a new building typology of public buildings to the Indian society;

hospitals, state administration offices, educational institutes, theatres, public libraries, museums, and town halls. Most of these Indo-Saracenic buildings are still functional and can be categorized as 'living heritage'. Owing to their present status, of being used as buildings of everyday use and not only as monuments of historical importance, the inter-relationship of social, cultural, climatic parameters and architectural character of these buildings becomes even more complicated. The energy performance evaluation of these buildings thus becomes an intriguing subject of study.

Current national and international imperatives to curb energy use and reduce greenhouse-gas emissions across the world, have triggered intensive efforts to formulate guidelines for new buildings and refurbishing existing buildings towards energy efficient construction. Along with regulations and guidelines, several countries have also developed voluntary standards, encouraging sustainability and higher energy efficiency buildings [1][2][3][4][5].

It can be understood, that in fast developing economies, energy consumption and production trends are even more demanding. In third world countries like India, a sincere effort to achieve energy efficiency in all sectors, especially buildings, is needed.

The Indo-Saracenic style, iconic to the typology of public buildings across the country, forms an integral part of the cultural and material resource of the country. These buildings, mostly under government ownership and largely for public usage, are used by many people, and thus demand a considerable part of societal energy use. Thus, there is a need to find ways to balance the needs of building preservation and energy conservation simultaneously.

The paper is a part of a PhD research work undertaken by the authors and discusses the status of the Indo Saracenic buildings as a part of the built heritage of the country. The paper also proposes to establish a need to conduct an energy efficiency assessment for this vast stock of historic buildings in India.

In the present times, when the science of making energy efficient building and identifying an appropriate aesthetic language for the contemporary built form are among the major challenges to the architecture fraternity, studying the delicate balance achieved between the two fields in an architectural style from history would add value to the theory of architectural history for India and also make Indo-Saracenic style a more useful reference for climate responsive building designs in future.

2. THE INDIAN SCENARIO

In India, various policy instruments to promote energy efficiency, have been in place since the 1970s. The Bureau of Energy Efficiency (BEE), Government of India in association with The United States Agency for International Development (USAID), has developed Energy conservation building code (ECBC) to improve energy efficiency in buildings. The first code for new buildings was adopted in 2007 and targeted exclusively large commercial buildings, that have, at least, a connected load of 500 kW or a contract demand of 600 kVA [6]. It consists of

prescriptive energy performance methods and sets requirements for different building components, such as air conditioning, artificial lighting, envelope, water heating, etc. The project has further carried out a number of activities ranging from developing an institutional framework for capacity building to benchmarking and demonstration projects across the country. The ECBC, however, is currently not mandatory across the country due to a number of challenges such as lack of appropriate knowledge and capacities at various government and private levels, limited availability of trained designers and architects, and the absence of suitable energy-efficient materials and equipment in the local market [7].

Globally, building energy performance and energy disclosure have been seen as important policy tools to improve energy efficiency in the building sector. For India, in order to put more emphasis on energy efficiency in existing buildings to consolidate the efforts related to benchmarking and labelling of commercial buildings, there is a need to take up energy audits, energy efficiency project implementation through energy service companies, measurement, and verification of existing built stock. A key performance indicator based on these reports and decision making with reference to specific cultural and social indicators, needs to be developed [8].

India is a huge reservoir of historic buildings. Its entire built heritage, listed or not, is a witness to the country's vast history and to the development of its social and constructional practices. With only 25 edifices listed as World Heritage Monuments by UNESCO, about 3,650 to be protected by national agencies, several thousand to be protected by state-level agencies, and many more unlisted and unprotected, the task of capacity building in studies related to historical monuments in India is onerous. The country has regulations and laws for governing the historic structures with their own limitations and conservative approaches; at the centre, the Monuments and Antiquities Act, 1952, is only restricted to protected monuments in the country. This was an amendment to an earlier Act of 1901 framed by the Archaeological Survey of India (ASI). At the State level, the Monuments and Antiquities Act, 1961, is adopted for protected monuments by most states. Some states have their own set of regulations for the maintenance and upkeep of the historic structures as laid out by their respective local bodies or archaeology and museums departments. The acts for the most part take into consideration the protected monuments which are very few. Most of the regulations and acts are concerned more about the exterior façade and the aesthetic characteristics of the buildings only.

Most of the Indo-Saracenic buildings are being used for public purposes like educational institutes, hospitals and government administrative offices and not only as heritage monuments on display as architectural wonders.

The staff in charge of these public buildings have no or very limited knowledge of the historic importance and preservation, which further leads to unplanned usage and changes to the building. The users of the buildings often find the historic importance and heritage values of the building a constraint to the use of the property. The public opinion of the historic buildings is moreover related to the

tourism prospects of the structures and the people mostly attach the cities and towns with the iconic buildings and the social and political stories attached with them.

The present use of these historic buildings for public activities like railway stations, hospitals, educational institutes and government offices, make them more vulnerable as well as important cases for study. Table 1 shows references of studies for historic buildings and their conclusions. Taking into consideration the contribution of studies conducted in climatic zones similar to India; it is well established that their historic buildings are climatically more adapted and incorporate passive strategies for achieving thermal comfort indoors. Holistic quantitative studies to understand and analyse the phenomenon scientifically have been missing for India which further lead to lack in learning from these historical buildings.

3. SCOPE OF STUDY: INDO-SARACENIC ARCHITECTURE

The development of architecture of the colonized nations, exhibits unique characteristics owing to the amalgamation of the native and foreign styles leading to a new discourse of architecture in a very short span of time. The architectural spectrum of British colonial architecture in India comprises of bungalows, barracks, institutional and technical infrastructure originally built to accommodate the everyday operations of the colonial administration and the needs of both “native” and “European” employees that served in its civilian and military branches. The revolt of 1857 was a turning point in the history of British India and had a significant impact on the British psyche. Henceforth a politically conscious use of architecture was adopted by the then Governors. The buildings were intended to make an impression, both on the Indian population, and on the neighbouring European nations. Indian Saracenic, is a term coined by the British upon a mixed architecture, of Hindu, Mughal and their own, and has been defined by various historians, architects and writers with their own perspective. Characterized by amalgamation of architectural elements of European and Indian architectural styles, its conception was always a combination of “European science” and native art of “traditional” forms with “modern” functions. The choice and mix of elements varies within different cultural regions of India depending on political biases, relationship of local rulers with the British and creative ingenuity of architect/engineer in handling local geo-environmental factors [9].

Though Indo-Saracenic architecture was a brief movement in time as compared to its other contemporaries like Mughal or Persian architecture, it left a permanent mark on the Indian architectural heritage and can be credited for lot of modernist elements adopted by independent India. The most important features of the buildings of this revival can be seen in Figure 1.

Mostly, government owned institutional buildings such as administrative and collector’s offices, law courts, municipal headquarters, railway stations, and universities, were built in this style and are still used largely for the same purposes. Designers to these buildings were often British officers appointed

by the Governors to conceptualize and formulate a style suitable for the Indian context. Most of these architects/engineers had their own philosophies and ideologies towards designing an appropriate style. The architecture of colonial India has been relatively well documented both scholarly and popularly, published since the 1960s.

Table 1. Review of Qualitative studies on climatic adaptations and use of passive elements in Historic architecture

Literature reference	Place of study	Type of study and cases cited	Elements studied	Conclusions drawn
E. Prianto. (2000) Tropical-Humid architecture in natural ventilation efficient Point of View; A Reference of Traditional Architecture in Indonesia.	Java Island, Indonesia (Tropical Humid)	Comparative Traditional, Colonial, Modern	<ul style="list-style-type: none"> • Building orientation • Roof shape • Natural ventilation in spaces 	Traditional architecture indicates direct relationship between form, climate and culture and is found to be more comfortable because of better natural ventilation
Samra M. Khan. (2010). Sethi Haveli, An Indigenous Model For 21 st Century 'Green Architecture'.	Peshawar, Pakistan (Hot and Dry)	Exclusive Haveli	<ul style="list-style-type: none"> • Courtyard • Orientation • Openings 	Modern interpretations of climatic responsive designs from the past can be energy conserving and culturally responsive
M. Dabaieh. (2014) Energy efficient design strategies for contemporary vernacular buildings in Egypt	Sinai, Egypt (Semi arid)	Exclusive Public Building	<ul style="list-style-type: none"> • Local materials, • Orientation • Building siting • Window design 	Awareness of regional environment and material concern would be helpful for contemporary practice
Ar. Rupa T.Ganguly. (2015). Role of Vernacular Architecture of India In Green Building Design – A case study of Pauni.	Pauni, Maharashtra, India (Hot and Dry)	Exclusive Wada houses	<ul style="list-style-type: none"> • Resources and recycled materials • Native construction technique 	Vernacular elements can be well integrated in today's new buildings with the aim of improving energy efficiency
Usha Bajpai. (2015) Use of Solar Passive Concepts in the Avadh Architectural Buildings and their Modified Impact.	Awadh, Uttar Pradesh, India (Hot and Dry)	Comparative Awadh European and Colonial	<ul style="list-style-type: none"> • Roof profile • Openings • Colour of external facade • Wall thickness • Chajjas 	Various building elements have been developed as solar passive concepts in different architectural styles
Tofigh Tabesh. (2015). An Investigation on Energy Efficient Courtyard Design Criteria.	Mesopotamia, Italy, China, Medallist (Different Zone)	Analysis of different zone	<ul style="list-style-type: none"> • Courtyard a design element 	Courtyard as an effective elements to modulate indoor climate and then energy efficiency of a built form
Hazrina Binti Haja Bava Mohidin. (2015) Regional Design Approach in Designing Climatic Responsive Administrative Building in the 21 st Century.	Malaysia (Hot and Humid)	Comparative Colonial and Contemporary	<ul style="list-style-type: none"> • Roof • Walls • Opening 	Façade elements are related to indoor comfort and energy efficiency
Prof. Vijayalaxmi K. Biradar. (2016). An Overview of Energy Efficiency in Vernacular Houses.	Kalaburagi Karnataka, India (Hot and Dry)	Exclusive Courtyard Houses	<ul style="list-style-type: none"> • Orientation • Building envelope • Building materials and technology • Microclimate 	Historical architecture as inspiration for now and innovative approaches to the design of adaptive and resilient buildings in hot and dry regions.

Nevertheless, there is still much work that needs to be done to explain adequately the relationships between the cultural construction of colonial South Asia and the actual formal construction, operation and performance of the built environment in the present context [10].

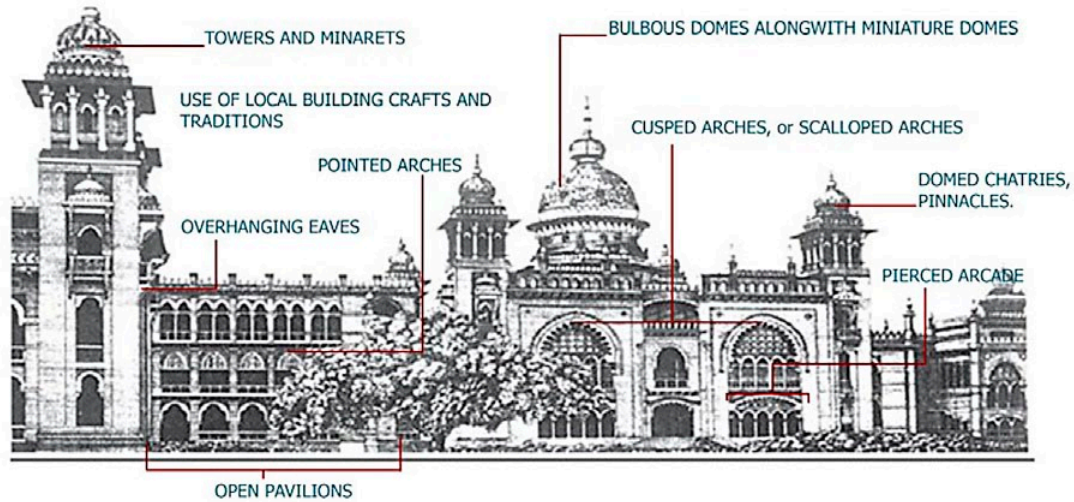

Figure 1. Prominent features of Indo-Saracenic buildings.

Although independent India's contemporary architectural practice, mostly influenced by western perception of building designs, has time and again ignored the rich and complex heritage of design systems prevalent in the country. Occupants of these public buildings, even in present times, have found these spaces more comfortable and appropriate for the extreme climatic conditions of varied parts of the country. A more scientific and a methodological study to understand the behaviour of these buildings and their individual elements, would add to literature on the relationship between the social, climatic conditions and the energy usage of this built stock.

Aspects related to Indo Saracenic buildings in India making them a special case for studying energy efficiency can be summarized as follows:

- 1) Old Town areas or the historic cores play an important role in the recognition and growth of many cities in the country like Hyderabad, Jaipur, Agra, Lucknow, Kolkata, Mumbai, etc. Many Indo-Saracenic buildings are trademarks of these cities, contributing vastly to their economic benefits and tourist interests, thus studying them for contemporary building standards and their up gradation, forms an essential aspect of these societies.
- 2) Present usage and location for a majority of these buildings is as identified administrative and public zones constituting a significant portion of the cities' area and energy demand. An improved understanding of the energy mechanism for these buildings can significantly contribute towards controlling the amount of CO₂ emissions in the heart of these cities and can further act as carbon sinks for the busy, crowded and polluted city centres.
- 3) The architectural characteristics of these buildings pose specific issues and aspects to their study. Further, the heritage laws for protection play an important role when the interventions involve the original appearance of the buildings.

- 4) These buildings being used for public use are often equated to contemporary buildings and are also expected to match their energy efficiency requirements. In the current state of art standards and codes, there is a lack of a specific protocol aimed at providing well-balanced solutions for the energy efficiency improvement in historical buildings.
- 5) Various vernacular and traditional buildings from different regions of the country have been studied for their heritage values, climatic adaptations and passive design strategies. Recently acknowledged field of achieving energy efficiency in buildings has not yet been greatly explored by scholars working on Indian historic architecture. Also, there stands a need for holistic quantitative study where with the help of detailed analysis judicious use of these buildings for contemporary purposes can be framed and further enhanced.

4. CONCLUSION

By looking at theory, policy, and practice on energy efficiency in heritage buildings through an interdisciplinary lens, policies can become useful and practices can become more relevant and pragmatic [11].

As identified by various studies, it is more likely to achieve energy efficiency benchmarks in historic buildings of tropical climates as most of the energy use is for cooling the indoor air. Owing to their huge built mass and design characteristics (in terms of spatial arrangement of spaces, s/v ratio in walls, size and location of openings, sun shading devices, etc.) these buildings ought to provide more comfortable indoor environment, especially during the long summer months and thus support energy efficiency. However, conducting an energy efficiency assessment for these buildings offers many challenges:

- 1) The primary documentation of the buildings, i.e. the drawings, materials and construction details are not readily available for reference owing to change of ownership and rapid social, political changes in the country immediately post construction of these buildings.
- 2) Since these buildings are being used for public usage like hospitals and educational institutes, alterations have been done to the interior spaces time and again.
- 3) The installation of electric fixtures and equipment have been found to be done in various time frames in history to the present, and thus belong to varied technologies and specifications which further complicates the energy consumption calculations.
- 4) The present rights to this historic stock is with many agencies simultaneously; for example the ownership of a building lies with the royal families who got them constructed or the State Government where undertaken post-independence; the buildings are being used by various government or private agencies like medical, education, hospitality or administrative departments as per usage; the maintenance and upkeep is mostly with the local municipalities or similar, and owing to the heritage status of many buildings the central or state archaeology departments formulate regulations.
- 5) The availability of technical know how and available software skills for the assessment process are not yet profoundly available as energy efficiency in buildings is comparatively a new field for study and practice in India.

- 6) The scale and size of the buildings is huge as they have been constructed for public purposes; this further adds to the complications and lengthy processes for detailed analysis.

The study proposes to critically examine the Indo-Saracenic public buildings to obtain insightful knowledge on the influence rendered by climate, materials used, and peculiar building elements on the energy efficiency of these historic assets. The proposed study will contribute to preparing the ground for the emergence of new projects on this topic and for addressing areas of much needed further research in the domain for the country.

Convergence of scientific reasoning and traditional wisdom through interdisciplinary research is vital in achieving social relevance of heritage protection in India, which in turn can spawn new research and business opportunities in technological frontiers, such as material science, software and computer technologies, environmental science, energy efficiency and sustainability.

5. REFERENCES

- [1] J. Carlo, R. Lamberts. "Towards a Brazilian standard for naturally ventilated buildings: Guidelines for thermal and air movement acceptability". *Building Research and Information* [Online], 39 (2), pp.147, 2017.
- [2] A.P.F. Andaloro. "Energy certification of buildings: a comparative analysis of progress towards implementation in European countries". *Energy Policy*, Vol. 38, pp. 5840–5866, 2010.
- [3] Vincenzo Franzitta. "Toward a European Eco-label brand for residential buildings: Holistic or by-components approaches?". *Energy*, Vol. 36, pp. 1884–1892, 2011.
- [4] Sandra Diaz. "Functional traits, the phylogeny of function, and ecosystem service vulnerability". *Ecology and Evolution*, Vol. 3, pp. 2958–2975, 2013.
- [5] Ye. "Discrimination of solid from liquid precipitation over Northern Eurasia using surface atmospheric conditions". *Journal of Hydrometeorology*, pp. 1345–1355, 2013.
- [6] A. Tulsyan. "Potential of energy savings through implementation of Energy Conservation Building code in Jaipur city, India". *Energy and Buildings*, Vol. 58, pp. 123–130, 2013.
- [7] Bhaskar Natrajan. "Challenges in Implementation of ECBC in India". *Implementing Energy Efficiency in Buildings: A compendium of experiences from across the world ICEEB*, 2015, pp. 18.
- [8] Shabnam Basssi. "Benchmarking of commercial buildings in India." *Implementing Energy Efficiency in Buildings: A compendium of experiences from across the world ICEEB*, 2015, pp. 105.
- [9] Sten Nilsson. *European Architecture in India, 1750–1850*. New York: Faber & Faber, 1969, pp. 158–165.
- [10] Peter Scriver, Vikramaditya Prakash. *Colonial Modernities: building dwelling and Architecture in British India and Ceylon*. London: Routledge, 2007, pp 3.
- [11] Kalliopi Fouseki et al. "Editorial: Energy Efficiency in Heritage Buildings – Future Challenges and research Needs". *The Historic Environment*, 5 (2), pp. 95–100, 2014.

The approach of the Walloon Heritage Agency on the energy upgrade of listed buildings

P. Delhaye

The Walloon Heritage Agency (AWAP), Namur, Belgium. Email: pascal.delhaye@awap.be

Abstract – The AWAP [1] coordinates and manages archaeology, heritage protection and the restoration of listed monuments in French-speaking Wallonia.

This article sets out the current process for managing the conservation and restoration of listed monuments in Wallonia and the integration of energy retrofits into the legal restoration procedures.

Two buildings of very different sizes, shapes and structures, illustrate how property owners, their architects and our agency can provide practical and realistic technical solutions to support heritage and the overall energy upgrade strategy.

Keywords – restoration; energy audit; priorities; return on investment

1. INTRODUCTION

1.1 THE AWAP'S PROCESS FOR WORKING ON LISTED BUILDINGS

1.1.2 What is the AWAP?

Created on 1st January 2018, the AWAP brings together the former Walloon Heritage Institute (responsible for assistance to individuals, training in heritage skills, publications and public buildings) and the Heritage Department of the Public Service of Wallonia (responsible for heritage listing, authorizations, financial aid, works control and archaeological research).

1.2 PRIOR TO RESTORATION PROJECTS–THE SANITARY STATUS DOCUMENT

The Walloon Heritage Agency (AWAP) has created the so called sanitary status document, rendered compulsory in 2010 by Article 212 of the Belgian Heritage Code [2], to ensure consistent quality and comparable treatment of the condition of monuments.

The author's task in the AWAP is primarily to write sanitary state sheets as an architect, and secondly, to control and advise the owners and their architect on the energy improvements of their listed building as an expert in energy audit.

The sanitary status document includes:

- a full description of the listed parts of the building;
- the damage affecting it;
- the ranking of the intervention priorities.

It must be updated every five years.

The priorities are on four levels, which last from six months to over five years. Respecting the established priorities gives right to a grant supplement of 10 percent of the amount of the restoration work.

It will soon be supplemented by the “heritage assessment” element to form the “heritage document”.

1.3 RESTORATION, DEVELOPMENT OR CONVERSION PROJECT

1.3.1 The heritage certificate

The “heritage certificate” procedure set out by the Heritage Code is a prerequisite for any work on a listed monument.

A support committee is formed to establish the conditions for this work, from the initial sketch to the work documents (plans and specifications).

The support committee is primarily comprised of the owner, the architect and representatives of the AWAP, the Royal Commission of Monuments, Sites and Excavations (CRMSF) [3], and other relevant authorities.

1.3.2 The planning permission

Planning permission is compulsory for all construction and modification projects, and is required for all listed and unlisted buildings [4].

Compliance with energy efficiency standards is set out in the Territorial Development Code (CoDT) [4]. The heritage certificate must therefore incorporate these standards into the project, together with fire, the wellness of employees, and safety standards.

The Decree on the energy performance of buildings (PEB) of 28 November 2013 [5] transposes European Directive 2010/31/EU of 19 May 2010 [6].

Article 10 of the decree states the exemptions for buildings that are listed, in the process of being listed, or included in the inventory of heritage sites. These exemptions apply to the extent that the application of certain minimum energy performance requirements may change inconsistently their character or appearance with the objectives of the classification.

- This exemption must be justifiable: the building’s status as a listed monument is not sufficient;
- The owners of listed monuments wish to upgrade the energy performance of their building;
- The AWAP must enforce the regulations and also help the owner by limiting the risk.

This retrofit involves two complementary aspects:

- the external structure: insulation of the walls, ground and roofs, and the replacement of the external woodwork;
- the systems: the choice of energy and the heating, ventilation, hot water and lighting installations.

1.3.3 The context for improvements to listed buildings

The role of the AWAP is to structure interventions to prevent any risks to the integrity of the listed building.

From experience, the life span of a development is much shorter than that of the building:

- a commercial development will be modified after a maximum of 10 to 15 years;
- the installations in a residence or museum are updated every 20 to 30 years;
- the complete restoration of a monument is scheduled within 50 to 100 years.

1.3.4 Total energy balance or audit

According to the cases, I recommend performing an energy audit to optimize the improvements and ensure they are relevant to the context [7].

This is an estimated and standardised energy balance of a heated building. The full evaluation covers the outer structure and the systems.

- The intervention scenarios must be appropriate for the listed building and the project;
- The dynamic calculation (assessed over a period of 2 to 4 years) of the dew point for each type of wall and the unfavourable thermal bridging, is generally requested.

Consequences for the project:

- the improvement of the envelope will be limited according to established risks and therefore less efficient than expected;
- the improvement of the systems and the choice of energy must compensate this deficit.

Every improvement made to the building must be reversible to allow other improvements in the future in line with technological progress.

2. PRACTICAL EXAMPLES

2.1 THE CASTLE OF FREÏR IN HASTIÈRE

The original fortified castle was destroyed by the French in 1554 during the wars against Emperor Charles V. The oldest part of the current castle, the east wing, was built in 1571. Most of the 17th century castle was expanded and redesigned in the 18th and 19th centuries. The castle and the site have been listed since 1956. The entire site is included in the list of exceptional heritage of Wallonia [8] [9] [10].



Figure 1. Castle, main entrance to the south. Photo: www.all-free-photos.com.

2.1.1 Energy audit of the castle

The energy evaluation was performed as follows:

- calculation of the simplified thermal balance of the outer structure of the protected areas;
- thermography to pinpoint the structure's thermal weaknesses;
- measuring of the temperature of the rooms and the exterior over a full year from March 2012 to March 2013;
- different Blower door tests were carried out;
- standardised consumption calculations by degrees/days;
- estimation of real, realistic and maximum consumption.

Four groups of rooms were identified according to their use, the temperature set points and the periods of use during the heating season from 15 September to 15 May.

Prioritising groups makes it possible to optimise the generation capacity and the investments in accordance with consumption.

(a) Structure and composition of the existing outer structure:

Heated floor surface: 3,076 m² Protected volume: 11,014 m³

Table 1. Loss from walls

Walls	Composition of the walls	Value U calculated (W/m ² K)
walls	brick, internal panelling or coating	1.5
low floors	brick	2
intermediate floors	layer of plaster, an air space between the wall plates and an oak parquet floor	2.05
insulated attic roof	insulating plasterboard (5 cm MW) under slate	0.46
non-insulated roof for the occupied attics	coating, air space and slate	4.5
frame	oak, single glazing	5.13
external doors	solid oak	2.75

(b) Existing heating system:

- Groups 1+4: atmospheric oil boiler + cast-iron radiators;
- Group 2: atmospheric oil boiler + cast-iron radiators;
- Group 3: local heating from electric radiators.

2.1.2 Improvement scenarios:

- Several saving simulations were created on the basis of the three types of consumption, the groups of rooms, and the possible interventions: sliding temperature burner or installation of three separate boilers; insulation of interior walls of heated/unheated areas, double glazing;
- The selected intervention scenario is the following, in accordance with the groups of rooms;
- roof or floor insulation of the attics in occupied areas;

- high-performing glazing + improvements to the seals of the frames;
- replacement of wet insulation;
- air-tightness, parasitic losses, automatic door closures, etc.;
- replacement of heat production by a single boiler: fuel oil or wood chip;
- Internal wall insulation was not selected, as the estimated 500 L savings (< 1 %) did not justify the investment;
- The castle’s existing energy balance is currently average for performances in Walloon properties in 2010;
- The improved result is in line with the current requirements for new housing (< 115 kWh/m².yr).

Table 2. Comparative balance

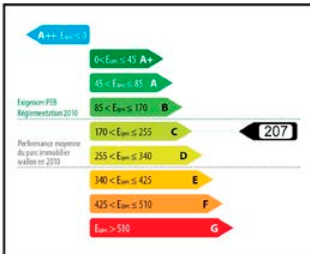
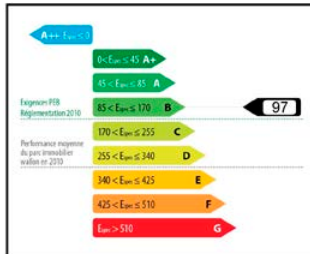
	Existing		Projected	
	Oil	Electricity	Oil	Electricity
Standardised annual consumption	53,000 L	28,500 kWh	28,000 L	0
<i>Primary energy consumption</i>				
<i>CO2 in full cycle - Gemis 4.5 value</i>				
Oil (10.647 kWh/L)	kWh	CO2 (T)	kWh	CO2 (T)
Electricity (*2.5 in Belgium)	71,250	20.66	0	0
Total	635,541	169.58	298,116	97.49
<i>wood chip version</i>			298,116	6.68
<i>Extrapolated balance on the certificate</i>				
<i>kwh.yr/m² heated floor</i>	206.61		96.91	
<i>label energy certificate</i>				

2.1.3 Improvement of the heating system

The principle of replacing the two boilers was established. The following still had to be studied:

- the replacement of the electric heating with central heating or heating cogeneration;
- the installation of one boiler or several smaller boilers;
- the choice of energy: fuel oil or wood chips.

Transforming the wood produced on the site made it possible to choose a separate collective boiler room with a single 150 kW wood chip boiler.

The farm’s former barn, part of which is unused, could house the boiler and all the necessary equipment: the hot water buffer tank, the controls and the wood drying and storage silos.

A hot water heat network would distribute the castle's circuits via an exchanger for existing circuits and the farm's new circuit, as well as being a reserve to other buildings to be heated in the future.

The investment is important. However, the use of firewood from the property's large forrest allows significant savings. Furthermore, the relative neutrality of the selected system's CO₂ production should be noted.

2.1.4 Improvement of the frames and windows

The idea was to retain the existing frames and add an additional internal frame, in the tradition of central and Eastern Europe and highland countries.

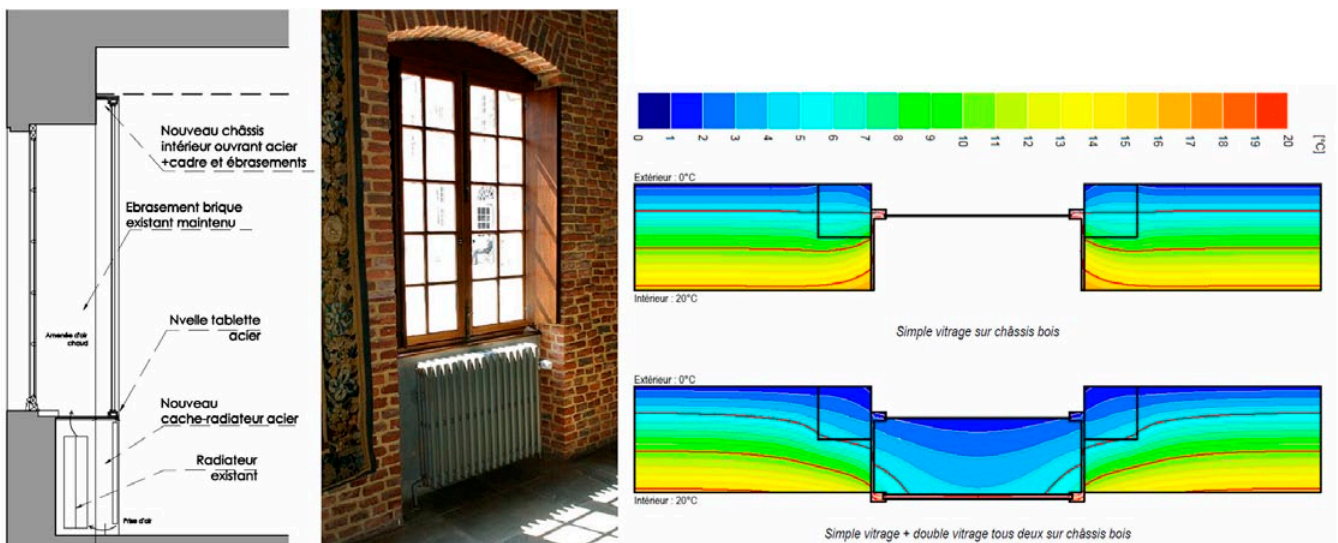

Figure 2. Installation of an over-frame and isotherms.

The consulting company studying the solutions for adding an over-frame recalled the technical constraints of such an intervention:

- 1) five types of embrasure of different designs: coated or paneled walls, wooden shelves, different depth of embrasures, etc.;
- 2) the presence of a radiator in the breast wall requiring an insulating plaque to be placed between it and the buffer area;
- 3) the aesthetic problem of incorporating an internal frame;
- 4) the cooling of the buffer space and the resulting internal condensation constraints;
- 5) the thermal stresses of the wooden embrasures and the damage they might cause;
- 6) the behavioural changes in the walls around these windows with the moving of the cold zones and the resulting reduction in comfort;
- 7) the worsening thermal weakness of the wall.

The support committee wanted to continue the discussions on this basis and a prototype was put in place to assess the visual and technical impact.

Following the CRMSF 's unfavourable intermediate report [3], I was consulted to deliver an opinion on the relevance of the proposed solution.

Advantages:

- Maintaining the uniformity of façades.

The recent frames (1952) have no archaeological value: they could be replaced.

Disadvantages:

- Replacing them at a later date would result in removing the over-frames;
- The solution is too complicated and onerous for an energy balance that is expected to be mixed;
- The output of the radiators masked by the façade of the counter-frame will drop.

The proposal for over-chassis installation was suspended.

I would agree to adapt an internal over-glazing on the frame.

- The thermal comfort will be improved and the sensation of comfort increased;
- The solution is economic and therefore more profitable;
- The thermal behaviour of the walls and the bay windows will not be modified.

2.2 THE LAMBRETTE RESIDENCE IN VERVIERS

2.2.1 Description of the building

The Lambrette building in Verviers is a 17th century half-timbered semi-detached house in an urban environment. The listing from 1970 applies to the façades and the roof. This is probably the oldest house in the town, and it is unoccupied. The City of Verviers bought the house in 2013 for development into four social housing units for vulnerable people [11] [12].

The planned programme involves:

- development of four 3- or 4-bedroom apartments, on four levels;
- maximum compliance with current housing and energy standards;
- housing for socially disadvantaged people.

2.2.2 Preliminary studies

The initial energy balance was not useful. The project completely modified the layout of the building's premises. the energy balance of a half-timbered wall is well known.

A dynamic behaviour study was carried out for the walls and thermal bridging.

The dynamic calculation allows to study the behaviour of a wall over a long period with seasonal variations. It is possible to check if the condensation accumulated in wet and cold periods can be eliminated during the dry period.



Figure 3. Main southern façade.
Photo: AwaP.

The dynamic behaviour study was required to provide guidance for the architect with regard to the techniques needed to reach an acceptable level, taking the following into account:

- the conservation of the wooden façades and plaster cob;
- the remaining useful surface areas after the internal insulation of the half-timbered walls.

2.2.3 Insulation of the outer frame

- Roof insulation:
 - the architect proposed insulating the sloping parts of the roof with a mineral wool mat, a vapour barrier and a trim panel under lathing. It would be necessary to insert mineral wool between the rafters to avoid any empty spaces;
 - the horizontal roof on the 3th floor would be insulated with a mineral wool-mat, leaving the rest of the unheated attic free;
- Insulation of the floor over the cellar:
 - ten centimetre polyurethane panels on a stabilised bed of sand separated by a polyethylene film;
 - OSB panels under the covering stuck onto sandstone tiles;
- The half-timbered outer walls:
 - the restored, treated existing oak frame and the renovated cob filling covered with a layer of whitewash with hydrated lime or silicate paint;
 - a 14 cm insulating layer of hemp wool that gives the wall the threshold value of 0.24 Wm²/K;
 - a variable permeance vapour seal creates a vapour barrier in winter and allows the walls to breathe in favourable weather conditions;
 - an internal top plate of covered plasterboard on 3 cm wooden battens;
- New reliable double-glazed wood frames that complies with PEB standards.

2.2.4 HVAC installation

- High quality ventilation must allow the dew points to dry out permanently and automatically. The support committee suggested the installation of a Smart Evo C+ system which combines automated mechanical air evacuation and supply;
- Heating is provided by hot water radiators connected to an individual natural gas condensing boiler with a modulating temperature regulated by a climatic sensor. Hot water is produced by the boiler.

2.2.5 Progress of the project

- Internal setbacks within the municipal administration have delayed the project, which is ready for the heritage certificate to be issued and the deadlines for certain types of funding have expired;
- The AWAP will continue the procedure once the new funding plan has been produced.

3. CONCLUSION

- The energy improvement of a listed building is globally identical to all other buildings, new or old: the design of the project must result in a good compromise between the investment and the hoped-for economy;

- A multidisciplinary dialogue is essential between the owner, the architect and the design offices. It is this dialogue that will make it possible to find the necessary compromises;
- AWAP adds to this dialogue the constraint of respecting the integrity of the listed building and requires guarantees that the planned interventions will meet this constraint;
- The main difficulty for AWAP agents is to overcome their reluctance to allow the desired improvements. Many still consider classified heritage as a cultural exception.

The presence of an expert in energy audit within the AWAP is very useful:

- to make the technical evolutions known;
- to allow their application;
- to change mentalities.

4. REFERENCES

- [1] AWAP : <https://agencewallonnedupatrimoine.be/>
- [2] Sanitary status document <https://agencewallonnedupatrimoine.be/restauration-et-reaffectation/>
- [3] The Royal Commission of Monuments, Sites and Excavations (CRMSF) <http://www.crmsf.be>
- [4] Territorial development code: http://spw.wallonie.be/dgo4/site_amenagement/juridique/codt
- [5] Energy policy: <https://energie.wallonie.be/fr/index.html?IDC=6018>
- [6] European Directive 2010/31/EU of 19 May 2010: <http://eur-lex.europa.eu/legal-content/EN/TXT/?uri=celex%3A32010L0031> (English version of the Directive).
- [7] Energy audit: <https://energie.wallonie.be/fr/audit-energetique-des-logements-pae2.html?IDC=6048>
- [8] Freÿr castle: <http://www.freyr.be/menu-freyr-in-english.php>
- [9] Collectif, *Le patrimoine monument de la Belgique* (volume 22². Province de Namur, arrondissement de Dinant), Liège, Pierre Mardaga editor, 1996, pp. 653–661.
- [10] Directory of listed properties: Freÿr castle: http://spw.wallonie.be/dgo4/site_thema/index.php/dossier/view/BC_PAT/91142-CLT-0008-01
- [11] Collectif, *Le patrimoine monument de la Belgique* (volume 11. Province de Liège, arrondissement de Verviers, entité de Verviers), Liège, Pierre Mardaga editor, 1984, pp. 196–198.
- [12] Directory of listed properties: Verviers, Lambrette house, Rue des Raines, 86: http://spw.wallonie.be/dgo4/site_thema/index.php/dossier/view/BC_PAT/63079-CLT-0007-01

Analytic hierarchy process

A multi-criteria decision support approach for the improvement of the energy efficiency of built heritage

E. Gigliarelli, F. Calcerano and L. Cessari

Institute for Technologies Applied to Cultural Heritage (ITABC), National Research Council of Italy (CNR), Monterotondo St., Italy. Email: elena.gigliarelli@itabc.cnr.it

Abstract – The paper addresses the theme of multidisciplinary decision support for energy efficiency in historic buildings through two research experiences: SECHURBA – Intelligent Energy Europe, and METRICS – an Italian PON-Research and Competitiveness project, where a multidisciplinary stakeholders group used the approach. A Multi-Criteria Analysis, the Analytic Hierarchy Process (MCA–AHP), was used to streamline the decision-making process during the design of energy improvement intervention on historic buildings. The tested methodologies provide best practices on the growing need for participatory processes to make informed choices involving very different disciplines. The MCA–AHP approach proved to be adequate for a balanced and solid formulation of the decision-making process: the workflow allowed a multidisciplinary group of actors with different skills to take a shared path that was first a path of knowledge and then a decision-making path, increasing their awareness and the effectiveness of the whole procedure.

Keywords – decision support systems, energy efficiency, built heritage, analytic hierarchy process, multi-criteria analysis

1. INTRODUCTION

Any intervention of architectural conservation oscillates between matters of method and matters of conservation practice. Employing a consolidated methodological approach to carry out an intervention does not automatically solve the questions on what could be the most suitable technical solution among a number of options, each one with a certain number of desired and undesired effects. Moreover, the stakeholders are increasingly numerous and range from the conservation expert, to the conservation technician, to the client (private or public) to the heritage protection public bodies. This paper describes the integration of a Decision Support System (DSS), the Analytic Hierarchy Process (AHP) within two scientific research projects focused on the proposal of new methodologies for the energy improvement of the built heritage. In both cases the approach was used as a participatory DSS among technical and non technical stakeholders to choose among a set of specific design alternatives developed by the research team after a multiscale and interdisciplinary analysis and design process (the theme of a photovoltaic roofing in the first case, the theme of the plant efficiency in the second one).

Historic buildings are not the largest nor the most energy-intensive part of our building stock and generally behave more efficiently than buildings built between the end of the World War II and adoption of the first energy efficiency regulation in the seventies [1], thanks to their climate sensitive design. Climate change will pose a threat to the continuation of their optimised natural functioning with even greater consequences on their conservation [2], therefore it will be increasingly important to develop adaptation methodologies to enhance their resilience. In recent years, the relationship between the disciplines of bioclimatic sustainable design and conservation (already anticipated by J. Ruskin and supported by restoration scholars such as R. Pane) has flourished thanks to the concept of energy improvement that has replaced the one of regulatory compliance, just like it happened in the structural consolidation field. Even if the process of disciplinary integration is still incomplete, environmental design and energy efficiency are starting to be accepted by conservation experts as protection tools for the built heritage [3], and several research project [4], [5] and initiatives like the JPI Cultural Heritage and Global Change are paving the road towards the maturation of a fully interdisciplinary approach.

2. MCA AHP AND THE ENERGY EFFICIENCY FOR THE BUILT HERITAGE

2.1 MCA FOR THE BUILT HERITAGE

Decision Support Systems (DSS), are tools designed to solve problems that are too complex for humans and too qualitative for a computer. They systematically guide the stakeholders through all the possible alternatives that can solve a problem within certain constraints. DSS have evolved significantly since their early development in the '70s, in the direction of information technology improving both the efficiency with which users reach a decision and the effectiveness of the decision itself. Moreover, these systems have helped over time to better respond to the need of stakeholders to include participatory evaluation procedures in their decision-making processes [6]. Within the decision support systems, the MCA supports the decision-maker that is forced to operate with numerous and conflicting assessments in obtaining a compromise solution in a transparent way. Support is provided by organizing and synthesising complex and often heterogeneous information, and MCA is ideal for an application in all those domains where it is not possible to directly apply an optimisation method [7]. Besides, the increase in the transparency of the decision-making process and, as already mentioned, the active involvement of the stakeholders in it, make the decision-making process even more controllable [5], [6]. MCA is applied in many areas of scientific knowledge [8]. This versatility is provided by the ability of the approach to make explicit the different alternatives while allowing the evaluation of their respective performances according to different criteria [9]. Given the complexity of the decision-making process within the built heritage conservation field [10] the use of MCA approaches, both as an instrument for the early design phases and for the final selection of the design solution among the proposed alternatives [11], [12], is gaining consensus [13]–[17] even within energy improvement interventions [5], [18]–[21].

2.2 AHP METHODOLOGY AND DECISION-MAKING PROCESS

As far as the decision-making in the built heritage field is concerned, the AHP process [22] is the mostly used approach [8], [14], [21], [23]. It represents an excellent and easy to use tool to answer to the need to solve unstructured problems and express complex judgments through a systematised methodology that prioritizes a series of decision-making alternatives by comparing qualitative and quantitative assessments otherwise not directly comparable. The following phases can be distinguished: main stakeholder and goal definition; formulation of the criteria; identification of the alternatives; organization of the criteria and alternatives in a hierarchical tree; pairwise evaluation of criteria and alternatives; and creation of the ranking of alternatives (choice). Finding all the stakeholders involved in the process along with the main goal helps taking into account not only the specific design problem, but also its whole contexts including the decision-making framework (i.e. the public administration that has the role to protect the building). When addressing problems with a high degree of complexity, goals can be hierarchically articulated from strategic ones, closer to the root of the AHP tree to more specific ones (in our cases evaluation criteria), as shown in Figure 1 based on one of the two presented case studies.

Within the design process, all the key actors must participate in defining the whole AHP hierarchical tree that must be as thorough as possible. Then a multi-disciplinary design team (made by the highest number of involved stakeholders) can develop the design alternatives, including technical and specific solution to address all the defined goals. After defining the design scenarios, highlighting for each solution a brief description along with a strength/weaknesses pre-evaluation, including when possible quantitative data, the evaluation phase can begin. The involved stakeholders are then asked to weigh the criteria and scenarios through a specific pair-wise comparison based on the semantic scale of Saaty [22], [24] as shown in Table 1.

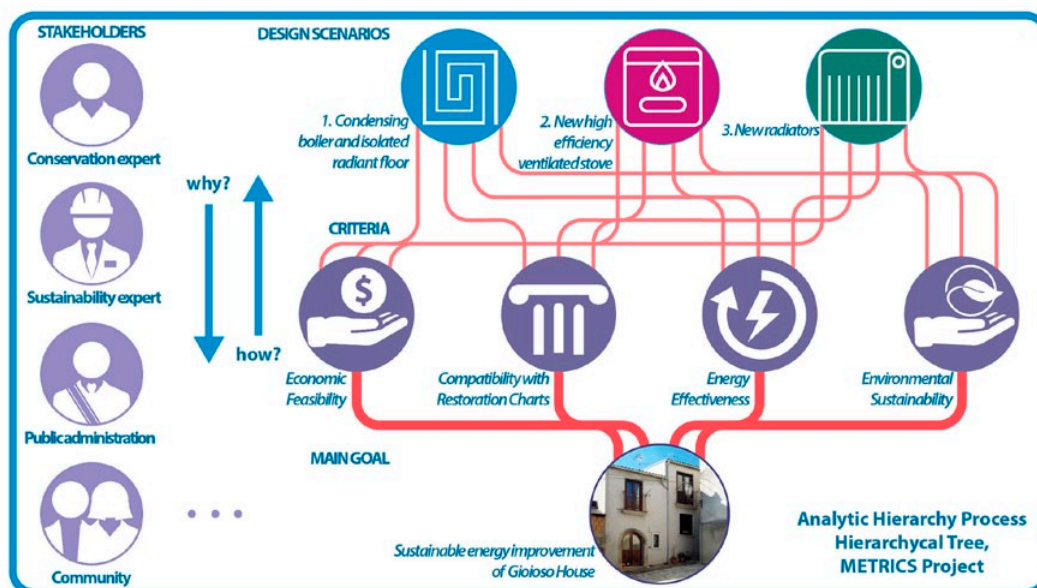

Figure 1. Analytic Hierarchy Process – Hierarchical Tree, METRICS Project.

Table 1. Saaty's semantic scale

Intensity	Importance Definition	Explanation
1	Equal	Two activities contribute equally to the objective
3	Weak	Experience and judgment slightly favour one activity over another.
5	Strong	Experience and judgment strongly favour one activity over another
7	Demonstrated	An activity is strongly favoured and its dominance demonstrated in practice
9	Absolute	The evidence favouring one activity over another is of the highest possible order of affirmation
2, 4, 6, 8	Intermediate	When compromise is needed

For each element of the hierarchy tree, a matrix is constructed by comparing in pairs the elements directly subordinated to it. Assuming the superordinate element as a reference, the two elements of each pair are compared in order to determine which of them is most important, and to what extent (i.e. in terms of compatibility with the restoration charts, which is the most efficient solution, "a" or "b"?). First the criteria are pairwise compared in relation to the general objective, and then the design scenarios with respect to each individual criterion. The result of the pairwise comparison matrix is a coefficient that represents an estimate of the dominance of an element relative to the other. For all the elements of the hierarchy, a weight is therefore obtained (local weights). To acquire the importance of each alternative according to the totality of the objectives/criteria taken into account, the hierarchical composition principle of Saaty [25] is applied, multiplying the local weights by the weights of the superordinate elements and then adding the results. Developing the calculations from top to bottom, the local weights of all the objectives of the hierarchy are progressively transformed into global weights. The global weight thus obtained from a single scenario will be compared with that of another alternative, highlighting an order of priority or preference in relation to the importance that each solution has scored in the pursuit of the individual objectives/criterion (as shown in Figure 3 of the last case study highlighted). Then the choice can be made. In specific cases, even the importance of the individual stakeholder can be weighted in order to make his answers more or less important in the final result of the decision-making process.

3. CASE STUDIES

3.1 OVERVIEW

After the first experiences in applying the AHP methodology on the built heritage to choose between specific conservation techniques, the Built Heritage Innovation Lab (BHI Lab, made of both conservation and environmental design experts) started to use it also for energy improvement interventions. In the two case studies highlighted, the BHI Lab coordinated the analyses, developed the design solution and implemented the AHP process to evaluate, within the developed projects (as shown in Figure 2), specific design goals (i.e. the

best roofing photovoltaic technologies or the best system upgrading), through questionnaires sent to the stakeholders. The questionnaires contained the pairwise comparison with the definition of the design problem, of the hierarchical articulation of objectives, of the criteria and design scenarios including a brief qualitative and quantitative description (provided by different experts), in order to include all the involved design sensitivity. For each case study, after collecting all the replies (with an acceptable grade of inconsistency below 0.1 [26]), we computed the AHP matrix and returned the results through various outputs.

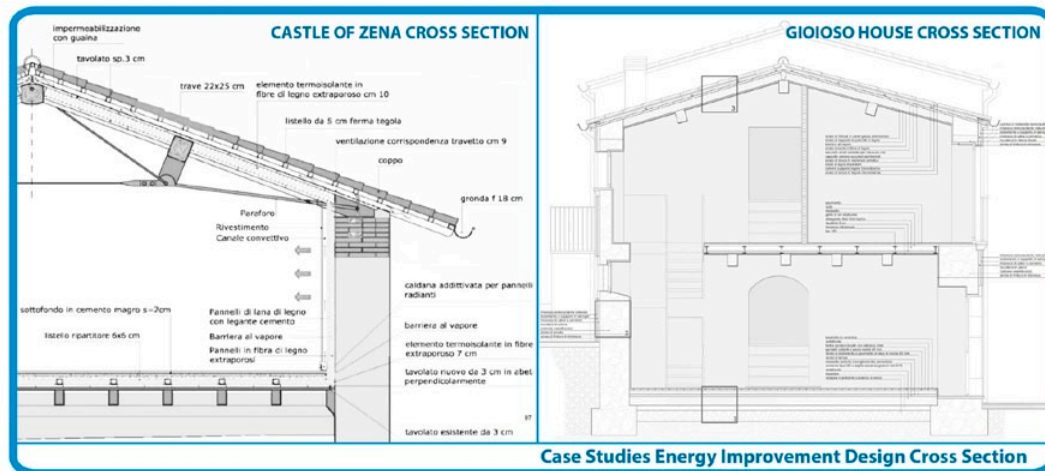

Figure 2. Case studies Energy Improvement Design Cross Section.

3.2 CASE STUDY 1 – THE INTELLIGENT ENERGY APPLICATION TOOL OF THE SECHURBA PROJECT

Within the Intelligent Energy Europe–Sustainable Energy Communities in Historic Urban Areas (IEE-SECHURBA) project, a software-based tool was developed to model potential energy improvements on historic buildings. The Intelligent Energy Application Tool goal was to help evaluate the Rational Use of Energy (RUE) and the Renewable Energy Sources (RES) integration on historic buildings, both in terms of their energy saving potential and in their aesthetic, historic, financial and administrative compatibility [27]. Within the tool, this latter part used the MCA-AHP process and was applied to evaluate the best photovoltaic roofing technology within the energy improvement intervention of the Castle of Zena, near Piacenza in Italy. A preliminary study was carried out to highlight the assessment criteria, studying international documents on historical rehabilitation and energy efficiency of the built heritage to develop four criteria:

- Compatibility with the international conventions of conservation along with the European charters of restoration;
- Energy effectiveness in terms of highest performance improvement of the historic building energy behaviour;
- Environmental sustainability, in terms of maximum reduction of carbon dioxide emission also through the use of RES;
- Economic feasibility, to evaluate the best return of investment.

The building was then surveyed and analysed taking into account climatic and site context, building typology, historical and geometric data, conservation state, and energy use. The project partners were then provided with a checklist to suggest new technologies and materials to be used within the energy improvement interventions, and to form an updated RES RUE database for historical buildings. The AHP hierarchy tree was then developed, and the evaluation criteria and solutions were weighted by a team made of building technicians (including architects, engineers and restorers), policy makers (European national and local governments, cultural heritage organisations), energy and climate organisations (SECHURBA national leaders and energy advisers), local energy markets representatives (technology manufacturers, developers and energy utilities), citizens and community. Among evaluation criteria, the compatibility with restoration charts was identified as the highest priority with a score of 0.46, followed by energy efficiency with a score of 0.24 and environmental sustainability and economic feasibility both with a score of 0.15. Within the photovoltaic design alternatives, the clay PV tile prevailed with a score 0.36, closely followed by the best scoring amorphous thin film with a rating of 0.30, while the other two technologies scored 0.17 (for the other PV tile system) and 0.15 (for the other thin film one) [27].

3.3 CASE STUDY 2 – PON RESEARCH AND COMPETITIVENESS–METRICS PROJECT

Following the SECHURBA experience, another test of AHP embedding within an interdisciplinary approach was performed on a building of traditional architecture (Gioioso House) in the historic centre of Frigento (Italy). The AHP methodology was partly deconstructed and integrated within the project “Methodologies and technologies for the management and requalification of historic centres and buildings” (METRICS), that was funded by the PON Research and Competitiveness 2007–2013 of the Campania region [28]. The core of the project was the development of multiscalar and interdisciplinary Heritage Building Information Modeling (HBIM) platform of the whole historic centre of Frigento with a focus on four specific buildings to support decision-making for energy improvement intervention at urban and building scale. The objective and stakeholders identification provided a “meta-design” support for project. The four evaluation criteria and the database of compatible RES and RUE technologies were fine-tuned starting from those developed within the SECHURBA project. The compatibility with the restoration charts criterion was enhanced with the concepts of the thermo-hygrometric compatibility between old and new materials and the potential of the intervention to support a sustainable future for the structure. The importance of external microclimate and building passive behaviour was enhanced for the Energy effectiveness criterion. Focuses on the life cycle of materials and technologies and on implementation and management costs of technologies were added to the Environmental sustainability and Economic Feasibility criteria. Within the database, for each criterion every technology was qualitatively pre-evaluated by the BHI Lab team with single scores from 1 to 5 (to provide a basis for the guidelines developed from the project). On Gioioso House historical and architectural analysis, geometric surveys, analysis of materials, analysis of the general conservation state, and the energy audit including field

and numerical analyses, were performed. Then the BHI Lab team developed an energy improvement design intervention of the house based also on a review of the owner's needs, which led to the development of specific solutions for the building envelope and heating systems. At the final stage of the design process, three different alternatives were selected to be tested in the AHP method:

- 1) the replacement of existing boiler and stove with new condensing boiler and new insulated radiant floor;
- 2) the replacement of the existing stove with a new high efficiency ventilated one;
- 3) the removal of the existing stove with the addition of new radiators.

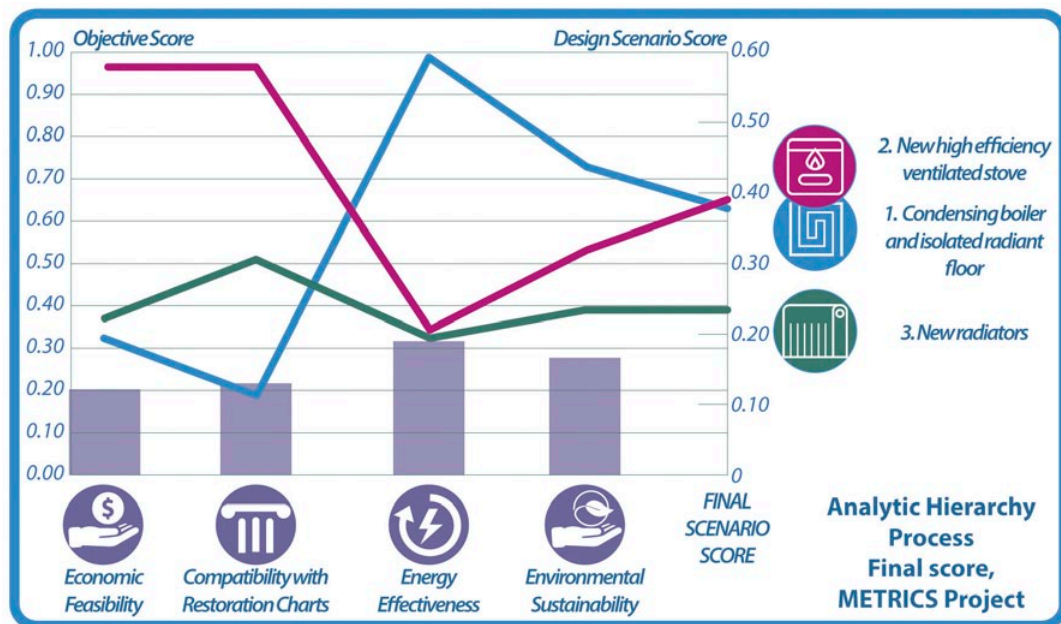

Figure 3. Summary Evaluation AHP Chart – METRICS PROJECT (on the x axis the four evaluation criteria are represented in their weight by bar chart, the three coloured line graph represents the trend of the three design alternatives in relation to the four criteria, showing how each partial score contributes to the final ranking of the alternatives).

Alongside the stakeholders were technicians from the research team: experts of building systems, environmental design, conservation and cost evaluation, municipality technicians and building owners. Compared with the Castle of Zena the architectural value of Gioioso House was lower, so the weighing of the evaluation criteria gave a different result with a prevalence of Energy Effectiveness with a score of 0.32, followed by Environmental Sustainability with a score of 0.27, Compatibility with the restoration charts with a score of 0.21 and Economic Feasibility with a score of 0.20. Even if, for the system design alternatives, the new ventilated stove solution prevailed with a score of 0.388, with an advantage gained over the other two right on the Economic Feasibility and Restoration Charts criteria. The more invasive and expensive but nonetheless more efficient solution of the new condensing boiler with insulated radiant floor followed closely with a score of 0.376, with the last solution at 0.236 as shown in Figure 3.

3.4 DISCUSSIONS

The impact on the workloads of the AHP process was not relevant compared to the efforts made for the analysis and development of design solutions, and the simplicity of the method allowed to easily create a common discussion framework for actors with different knowledge and skills up to the non-technicians. The major advantage (in addition to those already highlighted) was the possibility of recovering, in the final phase of the process, a general and shared vision on the results of the analyses and the proposed interventions, thus recovering the different design sensitivities of the experts involved, and recomposing in some cases contrasting position, in which experts of a specific field are naturally induced to give it greater weight than the others. Moreover, through the questionnaires, non-technician stakeholders had the opportunity to better understand the analyses, the efforts produced by the group and the issues involved in the intervention, developing a more informed point of view. For the public administration, the system served not only to integrate their considerations, but also to provide ideas for participatory processes, including those of a less structured nature. A “numerical” structuring of a delicate decision-making process, such as that of the energy improvement of built heritage, could seem too close to the hard sciences and too far from the humanities and thus capable of weakening their contribution to the process. Despite the fact that the dialectical relationship between hard sciences and humanities was formalized almost a century ago by the Athens Charter, the risk of a disequilibrium between the two contributions is always present and can be avoided, as suggested by renowned scholars like R. Pane, L. Grassi and G. Carbonara, only by giving technological formulation to the dualism whenever it occurs. The issue of the energy improvement of the built heritage makes no exception, and the use of the AHP approach proved to be adequate for a balanced and solid formulation of the decision-making process. The workflow allowed a multidisciplinary group of actors with different skills to walk together a shared path that was firstly a path of knowledge and then a path to take the right decision, increasing their awareness of the process and its effectiveness.

4. REFERENCES

- [1] K. Fabbri, “Energy incidence of historic building: Leaving no stone unturned,” *J. Cult. Herit.*, vol. 14, no. 3, Supplement, pp. e25–e27, Giugno 2013.
- [2] J. Leissner et al., “Climate for Culture: assessing the impact of climate change on the future indoor climate in historic buildings using simulations,” *Herit. Sci.*, vol. 3, no. 1, Dec. 2015.
- [3] G. Carbonara, “Energy efficiency as a protection tool,” *Energy Build.*, vol. 95, pp. 9–12, May 2015.
- [4] A. Martínez-Molina, I. Tort-Ausina, S. Cho, and J.-L. Vivancos, “Energy efficiency and thermal comfort in historic buildings: A review,” *Renew. Sustain. Energy Rev.*, vol. 61, pp. 70–85, Aug. 2016.
- [5] A. L. Webb, “Energy retrofits in historic and traditional buildings: A review of problems and methods,” *Renew. Sustain. Energy Rev.*, vol. 77, pp. 748–759, Sep. 2017.

- [6] J.B. Ellis, L. Lundy, and M. Revitt, "An Integrated Decision Support Approach to the Selection of Sustainable Urban Drainage Systems (SUDS)," presented at the SWITCH Conference: The Future of Urban Water; Solutions for Livable and Resilient Cities UNESCO, Paris Decision Support Tools; 24th – 26th January 2011, 2011.
- [7] M. Fabbri, E. Giovannoni, C. Mocenni, and E. Sparacino, *Reti di Indicatori e Dinamiche Complesse nella BSC: i Metodi AHP e ANP in Manuale del controllo di gestione*. IPSOA, 2011.
- [8] J.-J. Wang, Y.-Y. Jing, C.-F. Zhang, and J.-H. Zhao, "Review on multi-criteria decision analysis aid in sustainable energy decision-making," *Renew. Sustain. Energy Rev.*, vol. 13, no. 9, pp. 2263–2278, Dec. 2009.
- [9] P. Salminen, J. Hokkanen, and R. Lahdelma, "Comparing multicriteria methods in the context of environmental problems," *Eur. J. Oper. Res.*, vol. 104, no. 3, pp. 485–496, Feb. 1998.
- [10] G. Leijonhufvud and T. Broström, "Decision-making on Climate Control for Energy Efficiency and Preventive Conservation in Historic Buildings," in *Postprints from the Conference Energy Efficiency in Historic Buildings Visby*, February 9–11, 2011, 2012.
- [11] T.R. Nielsen, "Optimization of buildings with respect to energy and indoor environment." Departement of Civil Engineering DTU (DK), 2002.
- [12] D. Diakoulaki, C.H. Antunes, and A.G. Martins, "MCDA and Energy Planning," in *Multiple Criteria Decision Analysis: State of the Art Surveys*, Springer, New York, NY, 2005, pp. 859–890.
- [13] V. Ferretti, M. Bottero, and G. Mondini, "Decision making and cultural heritage: An application of the Multi-Attribute Value Theory for the reuse of historical buildings," *J. Cult. Herit.*, vol. 15, no. 6, pp. 644–655, Nov. 2014.
- [14] V. Kutut, E.K. Zavadskas, and M. Lazauskas, "Assessment of priority alternatives for preservation of historic buildings using model based on ARAS and AHP methods," *Arch. Civ. Mech. Eng.*, vol. 14, no. 2, pp. 287–294, Feb. 2014.
- [15] G. Leijonhufvud, *Decision making on indoor climate control in historic buildings: knowledge, uncertainty and the science-practice gap*. 2016.
- [16] H.E. Silva and F.M.A. Henriques, "Preventive conservation of historic buildings in temperate climates. The importance of a risk-based analysis on the decision-making process," *Energy Build.*, vol. 107, pp. 26–36, Nov. 2015.
- [17] J. Claver, M.A. Sebastián, and A. Sanz-Lobera, "Opportunities of the Multi-criteria Methods in the Study of Immovable Assets of the Spanish Industrial Heritage," *Procedia Eng.*, vol. 132, pp. 175–182, Jan. 2015.
- [18] L. Cessari and E. Gigliarelli, "Heritage-Led Eco-Regeneration: The Case of Zhejiang Water Towns Protection, Restoration and Preservation," in *Progress in Cultural Heritage Preservation*, M. Ioannides, D. Fritsch, J. Leissner, R. Davies, F. Remondino, and R. Caffo, Eds. Springer Berlin Heidelberg, 2012, pp. 369–377.
- [19] F. Roberti, U.F. Oberegger, E. Lucchi, and A. Troi, "Energy retrofit and conservation of a historic building using multi-objective optimization and an analytic hierarchy process," *Energy Build.*, vol. 138, pp. 1–10, Mar. 2017.

- [20] M. De Fino, A. Sciotti, E. Cantatore, and F. Fatiguso, "Methodological framework for assessment of energy behavior of historic towns in Mediterranean climate," *Energy Build.*, vol. 144, pp. 87–103, Jun. 2017.
- [21] A.N. Nielsen, R.L. Jensen, T.S. Larsen, and S.B. Nissen, "Early stage decision support for sustainable building renovation – A review," *Build. Environ.*, vol. 103, pp. 165–181, Jul. 2016.
- [22] T.L. Saaty, *The Analytic Hierarchy Process*. McGraw-Hill, 1980.
- [23] W. Ho and X. Ma, "The state-of-the-art integrations and applications of the analytic hierarchy process," *Eur. J. Oper. Res.*, vol. 267, no. 2, pp. 399–414, Jun. 2018.
- [24] T.L. Saaty, "Decision making with the analytic hierarchy process," *Int J Serv. Sci.* Vol 1 No 1 2008, 2008.
- [25] T.L. Saaty, "Fundamentals of the Analytic Hierarchy Process," in *The Analytic Hierarchy Process in Natural Resource and Environmental Decision Making*, Springer, Dordrecht, 2001, pp. 15–35.
- [26] R.W. Saaty, "The analytic hierarchy process—what it is and how it is used," *Math. Model.*, vol. 9, no. 3, pp. 161–176, Jan. 1987.
- [27] E. Gigliarelli, C. Bacigalupo, A. Cerqua, and L. Cessari, "Multicriterial approach for the evaluation of the compatibility of energy projects in historical buildings by AHP Method.," in *4th International Congress on "Science and technology for the Safeguard of Cultural Heritage in the Mediterranean Basin"*, Cairo, Egypt, 2009.
- [28] E. Gigliarelli, F. Calcerano, and L. Cessari, "Heritage BIM, Numerical Simulation and Decision Support Systems: an integrated approach for historical buildings retrofit," in *Elsevier Energy Procedia CLIMAMED 2017 Conference Proceedings*, 2017.

Decision support tool for the innovative and sustainable renovation of historic buildings (HISTool)

W. Hüttler¹, D. Bachner¹, G. Hofer¹, M. Krempf¹, G. Trimmel² and I. Wall²

¹ Department of Building Research, e7 Energie Markt Analyse GmbH, Wien, Austria,
Email: walter.huettler@e-sieben.at

² Trimmel Wall Architekten ZTGmbH, Wien, Austria

Abstract – The HISTool is a software-based tool for the analysis of the current building status, and a decision support tool for the innovative and sustainable renovation specifically of Gründerzeit buildings. These were built between 1840 and 1918 with partially standardized designs and components in Central-European cities. The tool is designed to be applied particularly in the preparation and decision-making stage of renovation projects in the Gründerzeit building sector, prior to the actual planning phase. For the decision-making process, it is essential to provide solid data on different renovation options in an early phase based on life-cycle costs, without a lot of calculation effort.

The calculation is based on a model of the building, which consists of 40 elements according to the specifics of Gründerzeit buildings and the selection of pre-defined renovation measures. The integrated energy performance and life-cycle cost calculation leads to the derivation of life-cycle costs of different renovation variants. A comparison of life-cycle costs of different renovation options leads to information-based renovation decisions.

The aim is to stimulate the Gründerzeit sector in the real estate market to implement more energy-efficient and innovative renovations, which are compatible with the specific requirements of historic buildings, and to contribute to the fulfilment of the climate-protection goals.

HISTool particularly reflects the environmental and economic goals of sustainable management of historic buildings according to EN 16883, and supports the planning and decision making procedure in the first phase as well as in the detailed planning phase when it comes to the selection of specific measures and assessment against the initial project targets.

Keywords – energy efficiency; refurbishment; decision support tool; life-cycle costs; Gründerzeit

1. INTRODUCTION

Gründerzeit buildings, also known as Wilhelminian-style buildings, date back to the period of 1840 to 1918. The term Gründerzeit refers to the economic growth period in the 19th century starting with the industrialisation. The need for living space in fast growing cities led to intense construction activities, mainly in the cities of the former German Empire and the former Austro-Hungarian Monarchy. The brick buildings share some key characteristics, such as standardised floor plans, standardised structural components, wall thicknesses, floor

heights, types of windows, and so on, which make them suitable for standardised analysis. Due to the fact that still almost 30 percent of all apartments in Vienna are situated in the 35.000 Gründerzeit buildings, substantial optimisation potential lies within buildings from this period. Even though many houses are made of good building substance, renovations are due simply because of the age of the buildings. Both the public call for conservation and complex elements, such as richly structured façades, vaulted ceilings in the basements, etc., call for special renovation techniques. Reliable information for building owners regarding innovative and technically feasible renovation options of these elements in particular, and for historic buildings in general, is scarce. Therefore, building owners often decide against thermal renovation measures. However, thermal renovation measures of the building shell, and measures in order to improve the technical building systems, are key to improved comfort and improved energy-efficiency of the building and therefore for climate protection. Another important aspect of renovation is the conservation of the building through protection of the historical building substance and a long-term increase of the building value.

The calculation of life cycle costs is already a well-established approach in the decision-making process of building renovation, with an ever-growing importance in real estate management. Building owners receive solid information and transparency to implement complex solutions based on long-term economic and ecological data. The application of life cycle cost analysis in the building sector is based on the observation that operational costs account for about 80 percent of the total costs of a building over its lifetime of 100 years [1]. For the optimisation of a building's total cost, it is therefore necessary to not only take into account initial investment costs, but all costs over the whole building lifetime need to be considered for a more holistic and transparent perspective. All costs are usually discounted and summed up to a present day value, known as net present value (NPV).

2. OBJECTIVE

The objective of this project is the development of a software-based tool (HISTool) to be applied in the status analysis and as a decision support tool for the sustainable renovation of Gründerzeit buildings. The tool is used at the earliest stage of the decision process, before the actual planning phase starts. It provides valid information about possible renovation measurement packages, their environmental and economic specifics and derives the variants life cycle costs, which essentially form the basis for the decision-making process of the building owner with nevertheless very limited calculation effort.

The calculation of life-cycle costs gives the building owner the chance to compare several renovation solutions and furthermore provides an early estimation of operational costs for the renovated building. This is an incentive for the widespread implementation of sustainable and energy-efficient renovations of Gründerzeit buildings.

Based on this pre-decision in the first phase of the planning process (decision on stop/go), the tool is used to support the selection of measures on a more detailed

level when it comes to the final assessment of packages of measures in relation to initial targets.

3. METHOD

A model of the building, which consists of 40 elements according to the specifics of Gründerzeit buildings, is the basis of the Excel-based software tool. Relevant elements and usage zones of Gründerzeit buildings are defined in diverse levels of detail, as displayed in Figure 1. The level of detail depends on the influence of a certain zone on the renovation costs. The zone General building is the most detailed as it contains all exterior building elements, which are key for the energy performance. On the other hand the zones Apartments, Basement, Common area, Elevator and Attic conversion, are defined less detailed.

Specific renovation measures are predefined for each of the 40 elements. The library contains a thorough collection of measures, e.g. to improve thermal resistance, to reduce thermal bridges, CO₂-neutral heat generation, to implement a ventilation system with heat recovery, measures to eliminate dampness in the basement, or for the static improvement of structural components. Every renovation measure is defined with its technical characteristics, thermal qualities (U-values), lifetime and costs, which compose data sets that are stored in a database, as can be seen in Figure 2. All data sets consist of a detailed description of the individual components, the cost of every component and the above described technical parameters.

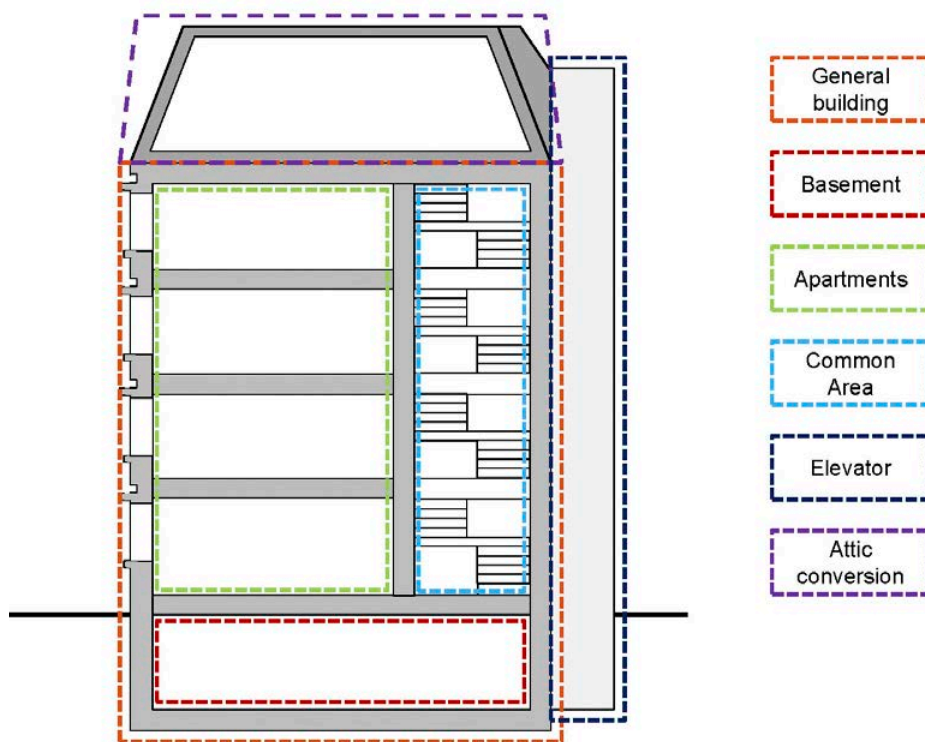

Figure 1. Building model, Source: e7 Energie Markt Analyse GmbH.

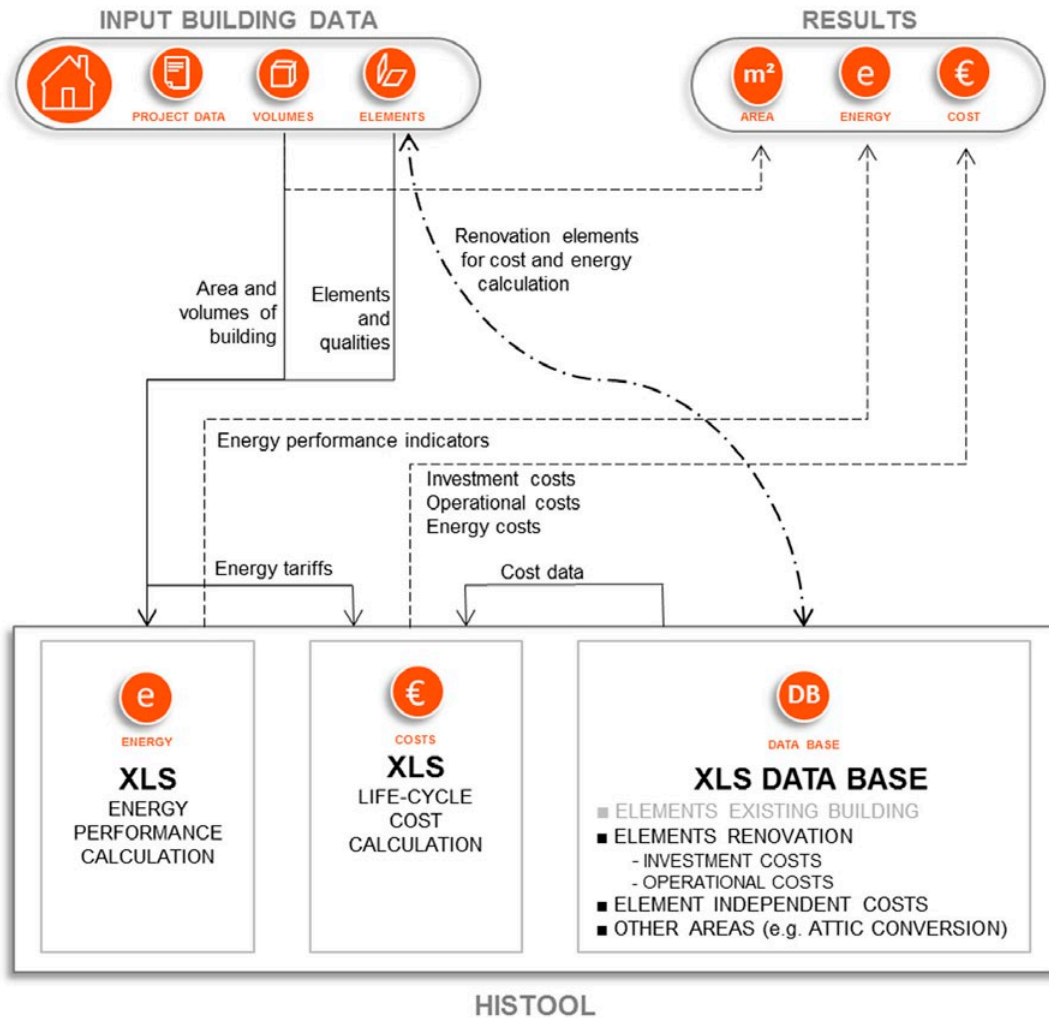

Figure 2. Tool structure. Source: e7 Energie Markt Analyse GmbH.

Database transactions are performed by the integrated energy performance calculation according to Österreichisches Institut für Bautechnik (OIB) and the life-cycle cost calculation according to ÖNORM M 7140. The energy performance calculation is based on the provisions of OIB Directive 6 and the referred Austrian standards. For a quick-and-easy calculation of heat transmission areas with limited input effort and parameters, pre-defined floor plan typologies and an automated area calculation are used. Alternatively, a detailed calculation is possible. All relevant inputs of building systems can be taken from the integrated database. The heat energy demand and energy costs are determined through defining the building model and the technical equipment.

The life-cycle cost calculation is a useful method to analyse all relevant costs of renovation solutions with a long-term perspective. Besides initial investment costs, operational costs such as energy, maintenance, service and repair, as well as replacement costs, are taken into account, see Table 1 (highlighted in blue).

Table 1. Structure of life-cycle costs acc. to ÖNORM B 1801-2

Cost Category	Property construction costs
0	Building site
1	Utility connection
2	Construction – carcasses
3	Construction – building systems
4	Construction – interior works
5	Furnishings
6	Outdoor facilities
7	Planning
8	Ancillary services
9	Reserves
	Oncost
1	Management
2	Technical building operations
3	Supply and disposal
4	Cleaning and care
5	Security
6	Facility services
7	Maintenance, reorganisation
8	Others
9	Demolition

Furthermore, revenues can also be considered in the calculation, which guarantees a high level of cost security at an early stage and presents the financial effects of the selected renovation measures. A calculation period of up to 50 years can be selected in the HISTool.

4. RESULTS

The result of the calculation procedure is a comparison of the life-cycle costs of different renovation variants, which reflect different thermal-energetic qualities. The detailed results contain the respective energy performance indicators, CO₂ emissions and a summary of all arising costs per variant structured in cost categories (carcassing, interior work, HVAC, electrical engineering, operational costs), the present value, the accumulated present value and so on, according to Figures 3 and 4.

Figure 3 presents the calculated life-cycle costs of the demonstration building Kaiserstraße 7 over a period of 30 years, including investment costs for a major refurbishment in year 0, replacement of the heat generation system (year 20) and windows (year 25), energy costs (electricity and heat) and costs for maintenance and repair of the technical building systems. Other operational costs are not incorporated. Energy costs depend on the energy performance level of the renovation variant.

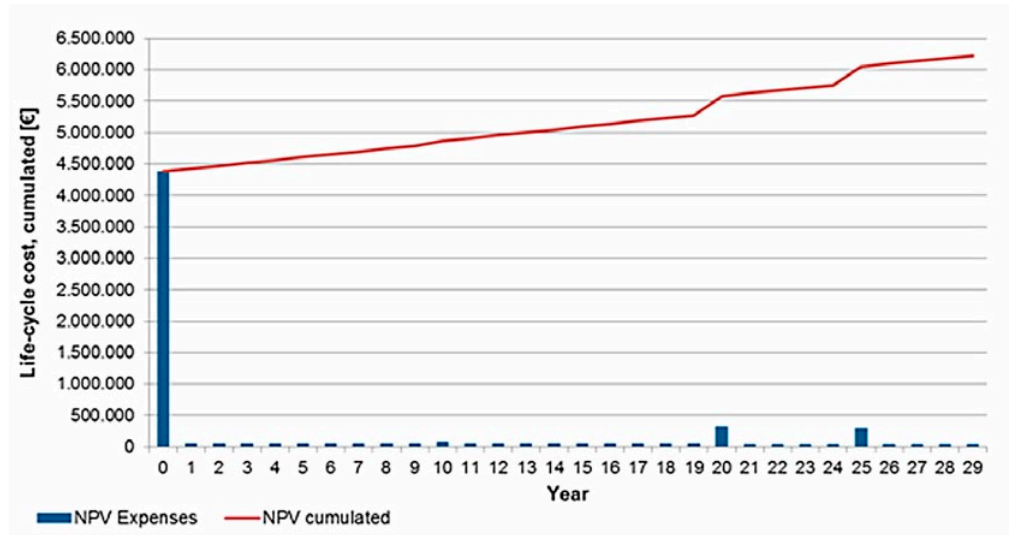

Figure 3. Net present value. Test result. Kaiserstraße 7, Vienna.



Figure 4. Demonstration building Kaiserstraße 7, Vienna. Source: akp Trimmel Wall Architekten ZTGmbH.

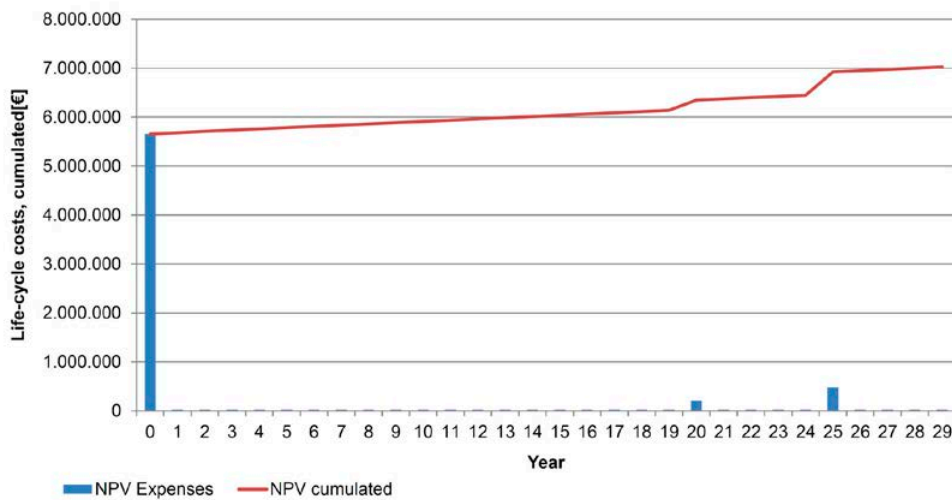

Figure 5. Net present value. Test result. Mariahilfer Straße 182, Vienna.



Figure 6. Demonstration building Mariahilfer Straße 182, Vienna. Source: e7 Energie Markt Analyse GmbH.

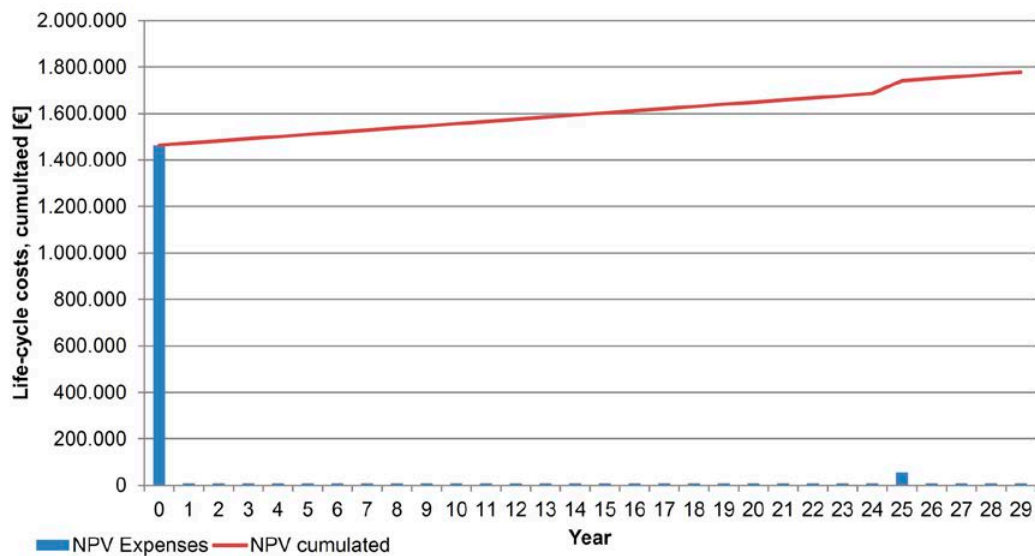

Figure 7. Net present value. Test result. Dingelstedtgasse 12, Vienna.

5. APPLICATION OF HISTOOL WITHIN THE DESIGN PROCESS

The tool is mainly used in the consultancy of building owners and real estate portfolio managers. It is applied in a twofold manner:

- During the preparation and pre-decision-making stage, prior to the actual planning phase. During this early stage of the process, it is essential to provide rough but solid data on different renovation options without a lot of calculation effort;
- During the detailed assessment and selection of measures in order to select and assess packages of measures in relation to initial planning targets.

This approach is closely linked to the new European standard “Conservation of cultural heritage – Guidelines for improving the energy performance of historic buildings” which was issued in July 2017 (EN 16883). The guideline describes



Figure 8. South view of demonstration building Dingelstedtgasse 12, Vienna. Source: akp Trimmel Wall Architekten ZTGmbH.

the decision making process of energy performance improvement measures in historic buildings. Similar to the objective of HISTool, the focus of the guideline is to guarantee a data-based and prudent selection of technical improvement measures.

The economic scope of refurbishment projects is mentioned in EN 16883 in a couple of passages. Economic assessment and economic sustainability are highlighted as important elements of sustainable management of historic buildings. The guideline states that the objectives of energy performance improvements of historic buildings shall consider economic viability (taking into account capital costs, operating costs including maintenance costs, economic return and economic saving). An economic assessment shall be undertaken and the guideline emphasizes that economic sustainability shall be one of the guiding principles for sustainable management of historic buildings. However, the guideline does not refer explicitly to life-cycle costs as a general decision making principle.

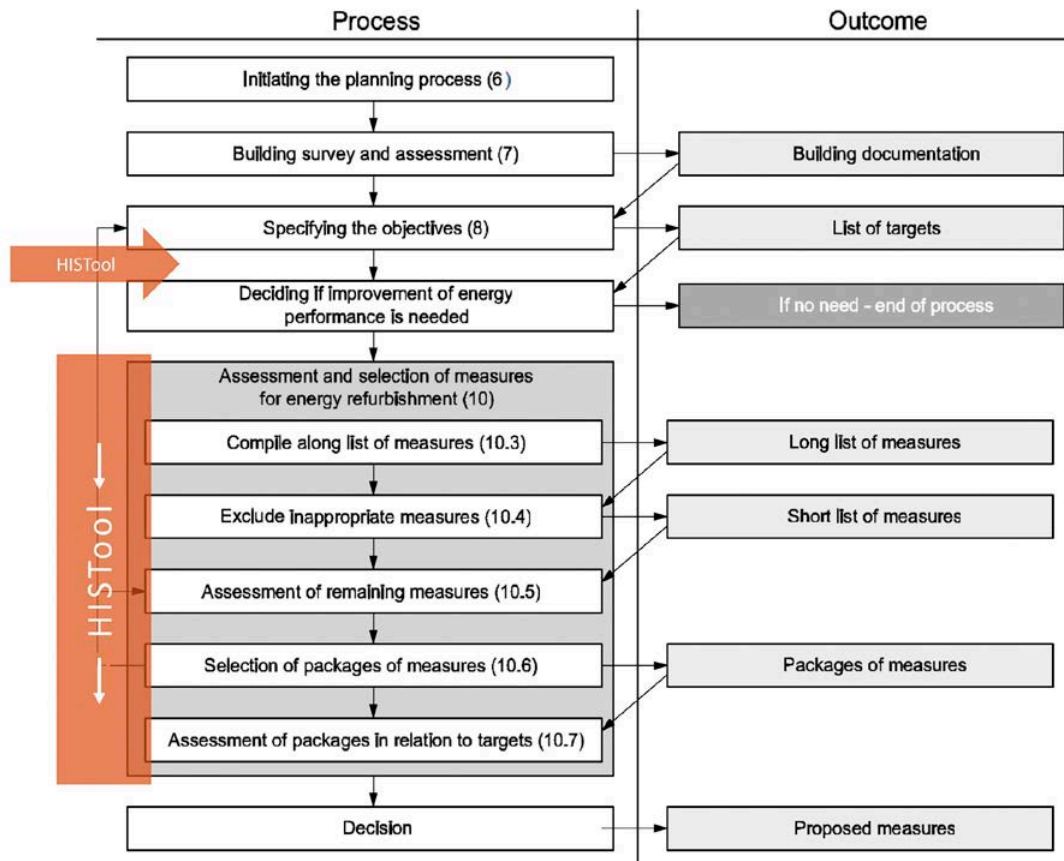

Figure 9. Flow chart showing the proposed procedure in EN 16883 (2017) and application of HISTool.

Figure 9 shows the proposed procedure from EN 16883 as ideal planning process from the initiation until pre-decision (stop/go) and the detailed assessment of measures until final assessment against the initial targets and final decision (highlighted in grey).

HISTool supports as well the initial process until pre-decision as the detailed design process when it comes to selection of specific packages of measures. After deciding if improvement of energy performance is needed and possible (initiation of planning process, building survey and assessment, definition of objectives have to be completed), the HISTool can be used for the assessment and selection of measures for energy refurbishment according to the standard EN 16883.

6. CONCLUSIONS

HISTool particularly reflects the environmental and economic goals of sustainable management of historic buildings according to EN 16883, and supports the decision making procedure in the first phase as well in the detailed planning phase when it comes to the selection of specific measures and assessment against the initial project targets.

7. REFERENCES

- [1] G. Hofer et. al: LCC-ECO Ganzheitliche ökologische und energetische Sanierung von Dienstleistungsgebäuden. Berichte aus Energie- und Umweltforschung 53/2006. Vienna, Austria. 2006, p. 55.
- [2] W. Hüttler, J. Rammerstorfer, U. Schneider and H. Schöberl. "Nearly Zero Energy Standard in historical Buildings – Innovative refurbishment of Wilhelminian style buildings" in Österreichische Ingenieur- und Architekten-Zeitschrift, vol. 157. Vienna, Austria. 2012.
- [3] Statistik Austria. "Mikrozensus 2013" in WOHNEN 2013 – Zahlen, Daten und Indikatoren der Wohnstatistik. Vienna: Statistik Austria. 2014, p. 19.
- [4] ÖNORM B 1801–2 Bauprojekt- und Objektmanagement. Edition: 2011-04-01. Vienna: Austrian Standards Institute. 2011.
- [5] ÖNORM M 7140 Betriebswirtschaftliche Vergleichsrechnung für Energiesysteme nach dynamischen Rechenmethoden. Edition: 2013-07-01. Vienna: Austrian Standards Institute. 2013.
- [6] Österreichisches Institut für Bautechnik. OIB-Richtlinie 6 Energieeinsparung und Wärmeschutz. [Online] Edition Oktober 2011. Available: <https://www.oib.or.at/de/guidelines/oib-richtlinie-6-0> [Feb. 28, 2018].
- [7] EN 16883 European standard on "Conservation of cultural heritage – Guidelines for improving the energy performance of historic buildings". July 2017.

Historic Building Atlas

Sharing best practices to close the gap between
research & practice

F. Haas¹, D. Herrera¹, W. Hüttler², D. Exner¹ and A. Troi¹

¹ Institute for Renewable Energy, Eurac Research, Dept., Bolzano, Italy.
Email: franziska.haas@eurac.edu

² e7 Energie Markt Analyse GmbH, Vienna, Austria. Email: walter.huettler@e-sieben.at

Abstract – Energy retrofit of historic buildings is a relatively new task in the construction sector. It is therefore important to offer reliable solutions to practitioners and end-users that prevent any undesired outcome. Often, the lack of trust and awareness of the available solutions is limiting the extent of interventions. This has a negative effect on the final energy savings and occupants' comfort, important factors when it comes to the use and conservation of historic buildings. The Atlas will provide an international collection of exemplary case studies that go beyond current practice in their scope and in depth of information provided. This unique collection of experience from all over the world will allow architects and building owners to browse through best practice examples and find the most relevant information to pursue their own renovation. The purpose of this paper is to show and discuss the need for such a repository as well as the functions and possibilities of the database.

Keywords – energy retrofit; database; best practice; case study; historic building

1. INTRODUCTION

1.1 OVERCOMING BARRIERS FOR THE RENOVATION OF HISTORIC BUILDINGS

The carbon saving potential associated with the energy retrofit of existing buildings is well known [1]. Historic buildings account for a large fraction of the residential built stock in many countries around the world. In the UK, Spain, Denmark and France, more than 20 percent of the existing buildings were built before 1919 and almost 40 percent before 1945. Their refurbishment could avoid the emission of up to 180 Mt of carbon dioxide (CO₂). Beyond the opportunity for energy and carbon savings, the built heritage needs continuous care and maintenance to sustain their functionality and avoid decay. As stated by the International Council On Monuments & Sites in their Charter on the built vernacular heritage [2], “*due to homogenisation of culture and of global socio-economic transformation, vernacular structures all around the world are extremely vulnerable, facing serious problems of obsolescence, internal equilibrium and integration*”. Improving the energy performance of these buildings will also improve the internal comfort conditions. Providing users with current standards of comfort is a crucial requirement to ensure the continued use of historic buildings over time and with that their conservation and durability.

Despite the numerous reasons for the renovation of the built heritage, the renovation rate of the existing built stock is still very low. The annual renovation rate in European countries ranges between 1.2 and 1.4 percent according to Dyrbøl et al. [3]. The renovation rate for historic buildings is undoubtedly even lower.

Previous research in the field has provided a first look into the motivations and limitations for the energy retrofit of historic buildings. Looking at previous experiences of 20 owners of traditional properties, Mallaband et al. [4] identified some common “*barriers*” in the improvement of their homes. These were related to (i) the householders’ values and preferences, (ii) concerns about professionals’ availability and expertise, (iii) the cost and (iv) time needed for the implementation, and ultimately (v) the compatibility with the historic features of their homes. Owners’ personal circumstances played a crucial role in the final decision and up to 70 percent of the households abandoned the idea of improving their homes because of “*their personal set of values*”. That is, the information and solutions available to the homeowners at the moment of making that decision were not sufficient to persuade them to include energy efficient measures in the renovation of their home.

In the last few years, researchers working in the field of historic building renovation, have developed a number of energy efficient solutions specifically tailored to these buildings. A lack of knowledge exchange between academic and industry environments has created a gap that limits the access of end-users to the most advanced solutions, restraining them from improving the energy efficiency of the built heritage. In addition to that, recent research has also focused on the development of evaluation tools (e.g. Heat, Air & Moisture simulation software to calculate moisture related risks) and procedures (such as the European EN-16883:2017 [5] that guides the designer during the entire decision making process) specific to historic buildings. Transferring this expert knowledge to the end user could be determining in overcoming the scepticism towards the professionals of the construction sector.

As stated by Vadodaria et al. [6], householders’ perception of the benefits of improving the building must exceed the disruption caused. In the case of historic buildings, that includes building’s appearance and the renovation’s effect on its aesthetics and durability. The interviews carried out by Sunikka-Blank & Galvin [7] with historic building owners in Cambridge, revealed the difficulties that “*retro-fitters*” faced when trying to balance the improvement of the buildings’ efficiency and the aesthetic preservation of their properties. In fact, aesthetics was as important as the economic criteria in the majority of the cases. Nevertheless, homeowners did not share a common vision of aesthetics or heritage

When retrofitting historic buildings, preserving their heritage value (including aesthetic, cultural and social aspects) is of major importance [8]. However, if the assessment of such heritage value is left to unexperienced end-users without additional information, there is a risk of undesired interventions due to users’ misjudgement of “*heritage value*”. Best practice examples could be a valuable

resource for practitioners and owners to learn from, especially if the implemented solutions are presented together with an explanation of the building's heritage value assessment carried out by an expert.

Lastly, Friedman & Cooke [9] suggested that the lack of consistency in the application and planning policies of local authorities might be acting as a barrier for the adoption of low-carbon measures in historic buildings. In some scenarios, a detailed documentation of the decision making process would be fundamental in the negotiation with the local authorities during the planning application.

A collection of well documented best-practice examples could also be a key resource in this process. However, the usefulness of a resource like this would depend heavily on the robustness of the examples showed. The verification and validation process would therefore be crucial in a successful implementation of such a repository.

2. BACKGROUND OF DATABASE ELABORATION

2.1 FOCUS ON HISTORIC BUILDINGS

There are already a number of accessible energy refurbishments compilations, each of them addressing a specific content or local focus. The table in Figure 1 provides an overview of the existing online accessible databases. Although this list does not claim to be complete; it presents the state of the art and serves as base for the argumentation that a new database expressly designed for historic buildings is needed.

None of the identified databases has an (exclusive) focus on the energy efficient renovation of historic buildings, with the exception of the compilation of the Sustainable Traditional Buildings Alliance (STBA). However, this repository has only included two project examples so far. Other databases also incorporate buildings of particular cultural value, either generally under renovations or as a special category and with an associated filter functions (e.g., dena). However, the most comprehensive surveys of energy-efficient renovations, as in Construction21 database or the examples collection of IEA SHC Task37, do not – or not with enough detail and visibility – consider specific requirements of the historic buildings such as (i) the historic and architectural value and the impact of the intervention on these values, or (ii) the decision making process. This process should take equally into account energy and cultural concerns. Furthermore, these databases are lacking a differentiated consideration of the construction details tailored to the diverse and heterogeneous features of historic architecture.

Ultimately, a best practice repository must leave enough room to explain why certain products and solutions have proven to work well in a particular historic building. Dedicated product databases for standard construction solutions (e.g. EffiBUILDING database: <http://www.ffibuilding.eu/db/>) will not meet these requirements since the depiction of the connection between the particularities of the building and the detailed solution is indispensable.

	DATABASE	PROJECTS INCLUDED <i>Renovation in general (R)/ Hist., Build.(HE)/ New Construction(N)</i>	RECORDED ITEMS <i>Districts (D)/ Buildings (B)/ Components (C)/ Products (P)</i>	CONSIDERED REGION <i>Europe (E)/ World Wide (W)/ Country/ Region</i>	FEATURES CONSIDERED <i>General Building-Information (A)/ Cultural Values (V)/ Construction of the thermal envelope (C)/ Energy Performance (BY) Building Services (B)/ Renewable Energy Systems (R)/ Planning Process+Business models (P)/ User comfort (U)/ Economic aspects (E)/ Environmental Assessment and Sustainability (S)/ Monitoring data (M)</i>	LEVEL OF INTERACTION <i>Only readable (R)/ Content searchable using Filter of building types (FR) and Solutions (FS)/ Leading to Decision Support (D)/ Possibility to comment (C)/ Open to add new projects (A)</i>	SIZE OF THE DATA COLLECTION <i>Number of recorded items: all projects (N+R)/ only renovation projects (R)/ only historic building renovations (HB)</i>	COMMENTS <i>enrollment process, reliability of data, quality assessment, level of detail etc.</i>
(1)	Construction21	N, R	D, B, C, P	W	A, C, E, B, R, S, X	FB, FS, A	468 (N+R) 91 (R)	Case studies are declared by the architect in a datasheet, basic data are mandatory, data reliability is stated by the customer; the case studies are generated, among others, from the applications for the Green Solutions Award, which is announced by C21.
(2)	Responsible Retrofit Knowledge Centre, STBA Sustainable Traditional Buildings Alliance	HB	B	UK	A, V, B, U	D, A	2 (HB)	General information on building construction and energy efficiency measures, no construction detail; The evaluation of the case studies should lead to a decision process within the project development.
(3)	IEA SHC Task 37: Advanced Housing Renovation	R, HB	B	W	A, (V), C, E, B, R	R	60 (R)	Report on lessons learned from a collective look at the case studies, involved countries: AT, BE, CA, CH, DE, DK, I, NL, NO and SE.
(4)	IEA SHC Task 47: Solar Renovation of Non-Residential Buildings	R, HB	B	W	A, (V), C, E, B, R, P, S	R	20 (R)	Non-residential buildings in three categories: educational buildings, office buildings and historic & protected buildings; report on lessons learned
(5)	dena (Deutsche Energieagentur)	N, R, HB	B	Germany	A, C, E, B, R	FB	ca. 1300 (N+R), of these 60% (R) and 5% (HB)	Registered buildings have to meet an "Effizienzhaus" standard. Registration of examples by architects with the consent of the owner.
(6)	ExcEED	R, N	D, B	Europe (EU)	A, C, E, B, R, U, S, M	FB, FS, D, A	work in progress	Continuous transmission of monitoring data. Database conceived for last generation of buildings but applicable to any building typology. The database integrates an IEQ survey and geocluster visualization tool
(7)	NZEC Zero Energy Residential Case Study Database Net-Zero Energy Coalition	N, R	B	USA, Canada	A, C, E, B, R, P	R, A	80 (N+R)	The most comprehensive source of North American zero energy residential case studies.
(8)	Klimaaktiv Gebäudedatenbank	N, R	B	Austria	A, C, E, B, R, U, X, S	FB, A	605 (N+R), of these 86 (R)	Declaration of all buildings according to klimaaktiv criteria
(9)	Passive House Database	N, R	B, C	W	A, C, E, B, R, U	FB, A	4270 (N+R) of these ca. 210 (R)	Passive House Buildings that have already been completed or are under construction (also EnerPHit certification). All information is based on data entered by the project registrant (planner or building owner)
(10)	SINFONIA Database of best available practices in energy-efficient refurbishment		P					
	Historic Building Atlas	HB	B	W	A, V, C, E, B, R, P, U, X, S, M	FS, FB, A		Elaborated in the IEA-SHC Task 59 as an online database specifically for historic buildings

(1) Construction21: <https://www.construction21.org/>
 (2) Responsible Retrofit Knowledge Centre, STBA Sustainable Traditional Buildings Alliance: <http://responsible-retrofit.org/search-results/>
 (3) IEA SHC Task 37: Advanced Housing Renovation <http://task37.iea-shc.org/publications>;
 (4) IEA SHC Task 47: Solar Renovation of Non-Residential Buildings <http://task47.iea-shc.org/publications>;
 (5) dena (Deutsche Energieagentur) <https://www.dena.de/themen-projekte/energieeffizienz/gebäude/bauen-und-sanieren/effizienzhaus-datenbank/>
 (6) ExcEED: <http://www.exceedproject.eu>
 (7) Net-Zero Energy Coalition, Case studies: <http://netzeroenergycoalition.com/case-studies/>
 (8) klimaaktiv Gebäudedatenbank: <https://klimaaktiv-gebaut.at/>
 (9) Passive House Database - common project of the Passive House Institute, the Passivhaus Dienstleistung GmbH, the IG Passivhaus Deutschland and the IPHA (International Passive House Association) and Affiliates: <http://www.passivhausprojekte.de/>
 (10) Database of best available practices in energy-efficient refurbishment <http://www.sinfonia-smartcities.eu/>

Figure 1. On-line available databases with best practice solutions for energy efficient renovation.

2.2 LOCAL – GLOBAL APPROACH

The adaptation of technical solutions specifically to the historic building stock has only been pursued in a local context so far. There are numerous publications (printed and online accessible) of energy-efficient renovations of historic buildings. These are often initiatives of the heritage authorities, sometimes in cooperation with relevant research institutions that tackle the respective stock of the region (i.e. Historic Environment Scotland Refurbishment Case Studies). An online example of these is the previously mentioned database of STBA for the UK. There is also the South Tyrolean historic Building Atlas – energy and culture (hBAT^{ec}, [8]), which is not online accessible yet. These collections are naturally limited in their sample size, but ambitious in the level of detail and the scope of information. In the Interreg Alpine Space project ATLAS, an extension of the data collection beyond the South Tyrolean area will be elaborated, since common building types can be found throughout the entire Alpine space.[9] The extension of a best practice database entails a hard to handle increase of building typologies, but leads to the possibility of global information exchange. The balance between local and global context is therefore a delicate issue that might have an important effect on the final use of the database.

2.3 BUILDING CLASSIFICATION

The decision of restricting the scope of the hBAT^{ec} to the local context was made based on the assumption that potential end-users (building owners and practitioners) would connect the local architecture, climate and handcraft traditions better with predefined local building typologies. Furthermore, it was expected that private owners and architects would rather access a database that is presented in their mother tongue [8]. The building typologies presented in hBAT^{ec} are linked to representative main historic building categories, in order to group similar buildings and promote transferability of solutions.

An approach to building classification based on individualized analysis of the historic building stock, as it was done in local samples, would not be applicable in the global context. In cases of large samples, a detailed questionnaire on the architectural elements and building type, as well as on the location of the building, would allow browsing through the collection in order to find the most suitable reference case.

3. BEST PRACTICE DATABASE FOR HISTORIC BUILDINGS

3.1 ELABORATION OF A NEW DATABASE

The investigation on existing best practice collections revealed that none of the databases meets the requirements of a comprehensive repository of examples of historic buildings energy refurbishment. In order to take the particularity of these buildings into account, the assessment of solutions applied in a historic structure requires a high level of detail and a targeted query strategy, something that none of the existing databases could offer so far. The discussion on the scope and content of such a database was introduced into the IEA-SHC Task 59 (“Renovating Historic Buildings towards Zero Energy”, <http://task59.iea-shc.org/>) and discussed

there with an interdisciplinary panel of experts. The newly-developed Historic Building Atlas (HBA) will fill the gaps of already existing databases by providing an open and web-based information source with the necessary information on historic buildings' specific details. The aim of the HBA is to make existing "best-practice experiences" available to the end-users for inspiration from these examples, and implementation in practice. However, this is not a homogeneous target group as it includes different stakeholders with different understanding of the complexity of the renovation process (e.g. architects & planners, building owners & real estate developers, public administration, and NGOs working in the field of historic buildings). Therefore, it is crucial to identify the characteristics that define a best practice as well as the requirements for the information to be provided. The latter is discussed in section 3.3, whereas the parameters that make a case study a best practice are presented below.

3.2 BEST PRACTICE CRITERIA

The scope of the examples to be included in the HBA will not be limited to a certain level of formal protection. Following EN-16883:2017 definition [5], any "*historically, architecturally or culturally valuable buildings, while respecting their heritage significance*" will be considered in the database. Furthermore, also in line with EN-16883:2017, the selection of case studies is not limited to any typology or construction period.

Every single historic building must be considered as a particular case. Establishing a single quantitative criterion or threshold (i.e. kWh/m²) to measure the degree of success of an intervention exclusively as a function of the energy saving, would go against this principle. The definition of best practice should therefore also be based on criteria that consider qualitative aspects of the intervention. The minimum requirements that case studies must respect in order to be considered best practice within the HBA are:

- *Renovation of the whole building.* The HBA aims at presenting examples that have considered the intervention in the building as a whole and not as a collection of single retrofit measures. Therefore, the cases included in the database cannot be limited to the improvement of a single aspect of the building and must have aimed at reducing the overall energy demand;
- *The project has been implemented.* Most of the limitations in the renovations of historic buildings appear when it comes to the compatibility with the existing construction and/or use. It is therefore important that the best practice example shows a renovation project that has already been implemented;
- *The intervention followed the results of a thorough heritage value assessment.* Energy improvement in historic buildings cannot be achieved at the expense of their heritage value. Therefore, the cases included in the HBA should include the results of such assessment in order to illustrate the relationship between the particularities of the building and the solutions eventually adopted;
- *A significant reduction of the energy demand was achieved.* The ultimate goal of the HBA is to pursue the lowest possible energy demand in historic buildings. The final value will however depend to a great extent on the

heritage assessment result and therefore will vary greatly from case to case;

- A detailed documentation of technical solutions & monitoring data is available. As discussed before, access to detailed and robust information might be important in overcoming the barriers to historic building renovation. Therefore, every example included in the HBA must be well documented and make this information available to the end-users.

3.3 IMPLEMENTATION

The HBA points to visual information transfer to reach end-users – especially building owners as well as planners and architects –: photos, short and concise texts, easy to read charts, drawings of solution details, and peer experience. A good browsing experience is also of major importance. Adapting the presentation of the information to the user device – be it a notebook, a tablet, a smart phone or a big screen. The site of *arch.atlas* (<http://arch.atlas.bz.it>) serves as an inspiration in this case. This project from the Architectural Foundation of South Tyrol adjusts the order and positioning of photos to the available space with a dedicated algorithm. The concept applied there should however be adapted for the presentation of much more comprehensive information in the case of HBA. The structured information in the background database of the HBA will allow the combination of text and images in a flexible way, side-by-side or consecutive, changing level of visible detail and organising information thematically.

The best practice examples should inspire users. The presentation starts therefore with images of the whole building and its interiors, describing in photos and text the aesthetic and historic values and how the responsible retrofit improved occupants' comfort. Also, some key data and contact details are shown. It then provides detailed information for those who want to learn more from the experience: on the one hand data on the specific context (historic, urban and climatic), architecture and retrofit concept targets – in order to help users to

The screenshot shows a web interface for a building renovation project. The top navigation bar includes: Architecture, Renovation Process, Thermal Envelope, Building Services, RES, Energy Efficiency, Internal Climate, Costs, and Environment. The main content area features a large photograph of a historic building and a text block with the following details:

Maso Rain, St. Magdalena Valle di Casies (IT)
rural residential buildings

Year of construction: 16th century
Retrofit: Full refurbishment, completion 01/2016

Location: Griesee/Tal, South Tyrol, Italy
Climata zone: F
Sea level: 1.900 m
Heating degree days: 4.722

Building typology: Listed building
Mixed construction (natural stone/log cabins)
 Residential building (4 holiday apartments)
Net floor area: 390 m²

Architect: Dr. Arch. Stefan Taschler
 archibio
 Paul von Sternbach Straße 9
 39031 Bruneck

Building owner: Michael Taschler
 Magdeisenstr. 29
 St. Magdalena Gries

RES (Renewable Energy Systems) icon

General description: This listed rural building, or Rainhof, was built around the 16th century in St. Magdalena at 1.500 m above sea level. It is located at the end of the Giesertal valley, just off the main road. It is one of the most precious rural buildings of the area. Ground floor was built with solid stone masonry walls, whereas first and top floor were built with the vernacular "Blockbau" (solid wood) technic. The building presents many traditional features, windows in deep joggles, decorated painted frames around the windows, and a vaulted ceiling at the entrance.

State-of-repair: Overall, the building is in a good condition. The ground floor in natural stone is largely well-maintained and the wooden construction of the first floor and the attic is well preserved. The wall on the ground floor and the northeast corner is contaminated with salts due to the adjacent septic tank. The lime plaster is partially damaged. The floorboards of the balconies are damaged.

Heritage value assessment: The project was developed in consultation and strong collaboration with the heritage office of Bolzano. That included: on-site inspection with building owner, architect and heritage office; discussion of the preliminary designs in the heritage office. The open dialogue and support between building owner, architect and heritage office ensured the quality of the retrofit in coherence with the construction regulation a high living quality and comfort in the building.

The right-hand sidebar contains a vertical navigation menu with categories: DESCRIPTION, INTERVENTION, and EVALUATION. Below the menu is a list of categories with their descriptions:

- Architecture:** Description of architecture, construction characteristics, state of repair, and heritage value of the building. It also includes descriptive data for case-study categorization.
- Renovation Process:** Overview of the renovation process with focus on the aim of the retrofit, type of intervention and building use, tools used, and involvement of stakeholders.
- Thermal Envelope:** Description of the interventions on walls, windows, roof and floors with special emphasis on compatibility of the implemented measures with the heritage assessment results.
- Building Services:** Summary of original and new building services for heating and DHW, cooling, and ventilation. It gathers information on typology, installation, and distribution system.
- RES:** Description of implemented renewable energy systems: solar (thermal + PV), wind, biomass, geothermal. Focus on building integration and conservation compatibility.
- Energy Efficiency:** Summary of the building's post-retrofit energy performance. Opportunity to include detailed energy data from calculations, monitoring or real consumption.
- Internal Climate:** Considerations on the effect of the post-retrofit internal climate on users' comfort, users' energy behavior, and artifact conservation.
- Costs:** Detailed information of the financial aspects of the retrofit. It offers the opportunity to break down investment and running costs showing the eventual financial
- Environment:** Overview of the environmental aspects of the intervention: life cycle assessment, water, indoor air quality, and transport and mobility.

Figure 2. Database interface (draft version based on the hBAT^{ec} proposal) and categories' characteristics.

understand whether the example is comparable to their case –, and on the other hand data on the different retrofit solutions applied, ranging from window, wall and roof improvement over airtightness and ventilation to the building services. Finally, also experiences from the renovation and related decision processes are shared: who were the stakeholders involved, and how decisions were discussed and made. Of course, also links to additional resources can be added. The background structure of the database is flexible: place for all possible aspects is provided, but only some key points are mandatory. What is actually presented depends on the focus of the single best practice and how to best communicate it.

An advanced filter function will allow narrowing down the amount of buildings to those of specific interest to the single user: buildings from a specific geographic area, of a specific period, use (residential, office, other), typology (detached, terraced, tenement), but also buildings with specific solutions applied as e.g. window improvement with secondary window or buildings with interior wall insulation.

Main providers of best practice cases will – at least in the first phase – be the front-runner architects and dedicated research projects. The HBA provides them with a Back-Office that goes far beyond a standard Content Management System (CMS). A self-explanatory tool will guide users through the documentation process, providing the fields for inserting the text pieces that later will be visible online, but also selectable keywords for the filter functions, sections to insert data that is then presented in charts, etc. A preview function helps understanding whether the images and the text pieces provided in single fields form a smooth and readable text.

The HBA aims at interlinking with other existing online resources. On the one hand, it will allow feeding information directly into other databases such as Construction 21 and the BuildUp case study collection. The definition of the database structure behind the website has been optimised to this regard. On the other hand, links can lead from short descriptions of a best practice in other databases to its more detailed description in the Historic Building Atlas.

Furthermore, database and web-concept are structured in a way that parts of the database can be shown in customised web-interfaces. This allows firstly to provide national versions of the HBA, enabling the access in countries where English might not be commonly used. Secondly, other running and upcoming projects can use the database and web-concept within their project website, with specific graphic project identity, showing there project related cases while at the same time feeding into the bigger complete database.

4. CONCLUSION

In conclusion, technological and non-technological barriers hamper raising both the quality and the quantity of energy refurbishments of historic buildings. Insufficient information and confidence are major barriers to energy renovation. The expertise developed by scholars and practitioners in the field of energy retrofit of historic buildings is not arriving to the end-user that still faces many

uncertainties when renovating a property due to the lack of specific information. Nevertheless, there are numerous case studies of low-energy renovated historic buildings developed as part of collaborative research projects between academia and industry. Providing end users with access to the information and lessons learnt in those projects, by means of robust and well documented examples organized in an open database, will help overcoming scepticism and prejudice against retrofit.

The HBA, as presented here, is still a work in progress. Aspects like the final interface and browsing features are still to be investigated. In the meantime, a base of exemplary case studies is already being collected within the IEA-SHC Task 59. However, the success of the HBA will be ultimately dependent on its ability to develop and grow over time. The input from researchers and practitioners, beyond the IEA-SHC Task 59, is essential to expand the collection of case studies included in the database.

5. ACKNOWLEDGEMENT

This work forms part of the IEA SHC Task 59/EBC Annex 76 research project, “Historic Buildings. Deep Renovation of Historic Buildings towards Lowest Possible Energy Demand and CO₂ Emission (nZEB)”.

6. REFERENCES

- [1] A. Troi. “Historic buildings and city centres – the potential impact of conservation compatible energy refurbishment on climate protection and living conditions,” in Proc. Conference on Energy Management in Cultural Heritage, Dubrovnik, 2011.
- [2] ICOMOS. “Charter on the built vernacular heritage (1999),” in ICOMOS 12th General Assembly, in Mexico, October, 1999.
- [3] S. Dyrbøl, K.E. Thomsen and T. Albæk. “European Directive on the Energy Performance of Buildings: Energy Policies in Europe – Examples of Best Practice Member States’ Strategy Towards Very Low” in Energy Buildings, pp. 126–140, 2010.
- [4] B. Mallaband, V. Haines, and V. Mitchell. “Barriers to domestic retrofit – learning from past home improvement experiences,” in Proc. Retrofit 2012 Conference, Salford, UK, 2012.
- [5] Comité Européen de Normalisation. Conservation of cultural heritage – Guidelines for improving the energy performance of historic buildings TC 346, EN 16883:2017, CEN, 2017.
- [6] K. Vadodaria, et al. “UK solid-wall dwellings—thermal comfort, energy efficiency refurbishment and the user perspective—some preliminary analysis from the CALEBRE project,” in Proc. Adapting to Change: New Thinking on Comfort, Windsor, 2010, pp. 1–16.
- [7] M. Sunikka-Blank and R. Galvin. “Irrational homeowners? How aesthetics and heritage values influence thermal retrofit decisions in the United Kingdom” Energy Res. Soc. Sci., 11, 2016, pp. 97–108.

- [8] F. Roberti, D. Exner, A. Troi. "Energy consumption and indoor comfort in historic refurbished and not refurbished buildings in South Tyrol: an open database." In Proc.SSPCR 2017, Bolzano, 22–24 March 2017.
- [9] The project ATLAS: Advanced Tools for Low-carbon, high-value development of historic architecture in the Alpine Space is co-financed by the European Regional Development Fund through the Interreg Alpine Space programme. (April 2018– April 2021).
- [10] K. Friedman and A. Cooke. "Is UK Planning a barrier to energy efficient heritage retrofit: a comparative analysis of a selection of London Boroughs," in Proc. Retrofit 2012 Conference, Salford, UK, 2012.

Life cycle assessment of Villa Dammen

User-driven energy efficiency versus new construction

M. Fuglseth¹, F. Berg², B. Sandberg-Kristoffersen³ and M. Boro⁴

¹ Asplan Viak AS, Sandvika, Norway. Email: mie.fuglseth@asplanviak.no

² The Norwegian Institute for Cultural Heritage Research, (NIKU), Oslo, Norway. Email: fredrik.berg@niku.no

³ Energibygg AS, Oslo, Norway. Email: bjorge@energibygg.no

⁴ The Norwegian Directorate for Cultural Heritage, (Riksantikvaren), Oslo, Norway. Email: marte.boro@ra.no

Abstract – This paper presents and discusses the results of a comprehensive Norwegian life cycle assessment comparing the net climate benefits of the refurbishment of a residential building from the 1930s with the construction of a new building in accordance with modern building codes. The study quantifies greenhouse gas emissions from use of materials in the refurbishment process, helping us understand the building as a technical system. The study also considers the significance of user aspects in the planning of energy retrofits and energy management by using standard (NS 3031) and adjusted calculations for different user profiles. Results show that a careful energy efficiency refurbishment of the historic building is favourable from an immediate climate change mitigation perspective but that it takes 60 years for the new building to recoup its environmental investment. It is discussed why and how residents play a critical part with respect to realising the expected energy savings related to upgrading historic buildings.

Keywords – life cycle assessment; Norway; user aspects; emissions from material use; operational phase

1. INTRODUCTION

1.1 BACKGROUND

Today's green building guidelines encourage home owners to consider measures that affect the appearance and physical characteristics of a building. By focusing our attention too narrowly on energy efficiency measures, we tend to overlook the sustainability asset that the building represents if maintained and used efficiently. Comprehensive measures to the thermal envelope of the building will reduce operational energy use but can also lead to a net increase in life cycle greenhouse gas emissions. The reason is that energy use represents only one part of a bigger picture that includes materials production, transport, construction, use, and demolition.

Knowledge regarding the topic of operational energy use in dwellings is increasing, largely due to the general societal focus on new energy efficient homes. Yet, measurements often demonstrate that the actual energy consumption in new homes exceeds calculated values [1]. The situation is often the reverse for

historic buildings. We know that this is explained partly by new energy systems being less efficient in practice than expected, but to what extent is it explained by the behaviour of users and residents, and how can those aspects be quantified?

To better illustrate this, the Norwegian Directorate for Cultural Heritage released a comprehensive life cycle assessment (LCA) in 2017. It compared the total life cycle greenhouse gas (GHG) emissions for a historic home before and after upgrading, to a scenario where an existing building was demolished and replaced by a new dwelling built in accordance with today's technical requirements. The objective of this paper is to present and discuss the results from that study.

1.2 PREVIOUS RESEARCH

The new European Standard for improving the energy performance of historic buildings acknowledges the importance of assessing the whole life cycle of a building by stating that “historic buildings should be sustained by respecting the existing materials and construction, discouraging the removal or replacement of materials / ... / which require reinvestment of resources and energy with additional carbon emissions” [2]. This has been an acknowledged idea in building conservation for quite some time [1, 3–5]. More recently, studies have pointed to the general knowledge gap regarding how the users of historic buildings represent an untapped energy saving potential possibly equivalent to that of some technical measures [6, 7]. The Nordic CERCMA investigation from 2014 acknowledged a similar outlook by concluding that “the influence of behaviour tends to be more apparent to the user of historic buildings” than buildings in general, e.g. since older heating systems such as wood burning stoves require active residents [8]. Two pieces of LCA research commissioned by the Norwegian Directorate for Cultural Heritage in 2011 and 2015 respectively indicated that traditionally constructed buildings could be environmentally favourable to comparable buildings constructed with materials in common use today [9]. However, neither of these two studies did further problematising calculation methods, nor energy saving impacts related to user behaviour. This eventually led to a third LCA study which will be presented in the following.

2. METHOD

The 2017 LCA was commissioned by the Norwegian Directorate for Cultural Heritage, aiming to measure the net environmental benefit of refurbishing a historic dwelling, Villa Dammen in Moss, Norway, taking into account both operational energy use and consumption of materials.

Villa Dammen was built in 1936, with a timber-frame structure, outside vertical wooden cladding and a full concrete basement, see Figure 1. The building represents a common type of building from the 1920–30s with cultural heritage significance connected mainly to its visual appearance, shape, and materiality. Up until its refurbishment in 2014, heating was supplied by an oil boiler, electric radiators and an air source heat pump (air/air). Annual energy use before refurbishment was estimated 427 kWh/m²/yr.

Energy efficiency measures carried out in 2014–15 were chosen with general consideration to preserving historic material, passive design qualities in the construction, as well as the planned use of the building, and expectations on indoor comfort, etc. Measures included weather proofing of windows and doors, added insulation to pipes and the domestic water heater in the basement, a waste water heat recovery system, added interior insulation to floor slabs/beams between basement and attic. A massive heat-storing brick stove was built in the centre of the first floor which also preheats the domestic water, see Figure 2. The stove was constructed with ca. 2 metric tons of brick. A blower door, which was used to measure air tightness, showed a reduction pre- and post-upgrading = from 7.8 l/h to 4.4 l/h. After the energy efficiency measures had been carried out energy use was calculated to 287 kWh/m²/yr.



Figure 1. Villa Dammen, south façade during winter, north façade during summer. Image: Google maps.

The LCA study was carried out as a comparative assessment with three scenarios: (1) Villa Dammen baseline with no refurbishment, (2) Villa Dammen with refurbishment, and (3) a demolished Villa Dammen which is replaced by a new dwelling built according to current Norwegian building practices. The study was conducted in accordance with current LCA standards NS 14040:2006 [10] and NS 14044:2006 [11], using environmental impact data from the 'ecoinvent' database and environmental product declarations (EPDs). The reference building used for calculating emissions in the new construction scenario was based on a building of equivalent construction, size, and use as Villa Dammen, built in accordance with the Norwegian building code (TEK10, cf. a passive house). Calculations accounted for emissions associated with the use of construction materials and energy required over the entire life cycle to build, operate, maintain, and dispose of the considered buildings. A period of analysis of 60 years was used, in accordance with standard practice for LCAs of buildings in Norway, to ensure comparability with similar studies.

The residents of Villa Dammen make use of temperature zoning during the heating season as well as reducing the set temperature of the building when they are not at home. These measures are not considered standard in operational energy use simulations, and actual measured energy use in Villa Dammen over the two years after refurbishment is significantly lower than the estimated



Figure 2. First and second floor in Villa Dammen. Yellow colour shows the area that is permanently heated, including the centred new brick stove. The wall between the two larger rooms in the first floor is removed. The basement is not shown and has not been included in the energy modelling. Second floor rooms are indirectly or intermittently heated.

energy consumption used as a basis for the LCA. Recent research supports this finding, indicating that the assumptions regarding energy use behaviour used in standardised energy use calculations do not reflect the behaviour of inhabitants of existing dwellings [10, 11].

The study therefore also explored how different assumptions for calculating energy use in the operational phase, as well as for calculating greenhouse gas emissions from energy use, affect the results. The impact of user behaviour on energy use and emissions was assessed by introducing an alternative set of parameters for energy use calculations. These represent a more conscious attitude to energy use, including use of temperature zoning. The results were also held up against the actual measured energy consumption in Villa Dammen post-refurbishment.

Our attempt to define an alternative set of standardised values for energy use calculations, which reflect the energy use behaviours of more “conscious” residents, is typical of historic buildings where, for instance, indoor temperature tends to be more unstable. The main differences, compared to the NS 3031 standard, concern reduced ventilation operating hours, reduced energy use for domestic hot water consumption, lower indoor temperatures outside operating hours, and greater use of temperature zoning.

3. RESULTS

The analysis shows that the refurbishment of Villa Dammen causes approximately 295 tonnes CO₂-eq less than the scenario without refurbishment over 60 years. This amounts to a 67 % reduction in total GHG emissions. Consumption of construction materials during refurbishment causes emissions from material use

to be 25 % higher for the refurbished building, but this increase is dwarfed by a 70 % decrease in emissions from energy use.

A new building constructed according to modern standards will be significantly more energy efficient than Villa Dammen, causing energy related emissions to be 40 % lower for the new building. However, due to the large amounts of construction materials used to construct the new building, total GHG emissions over 60 years are only 8 % lower for the new construction, compared to Villa Dammen.

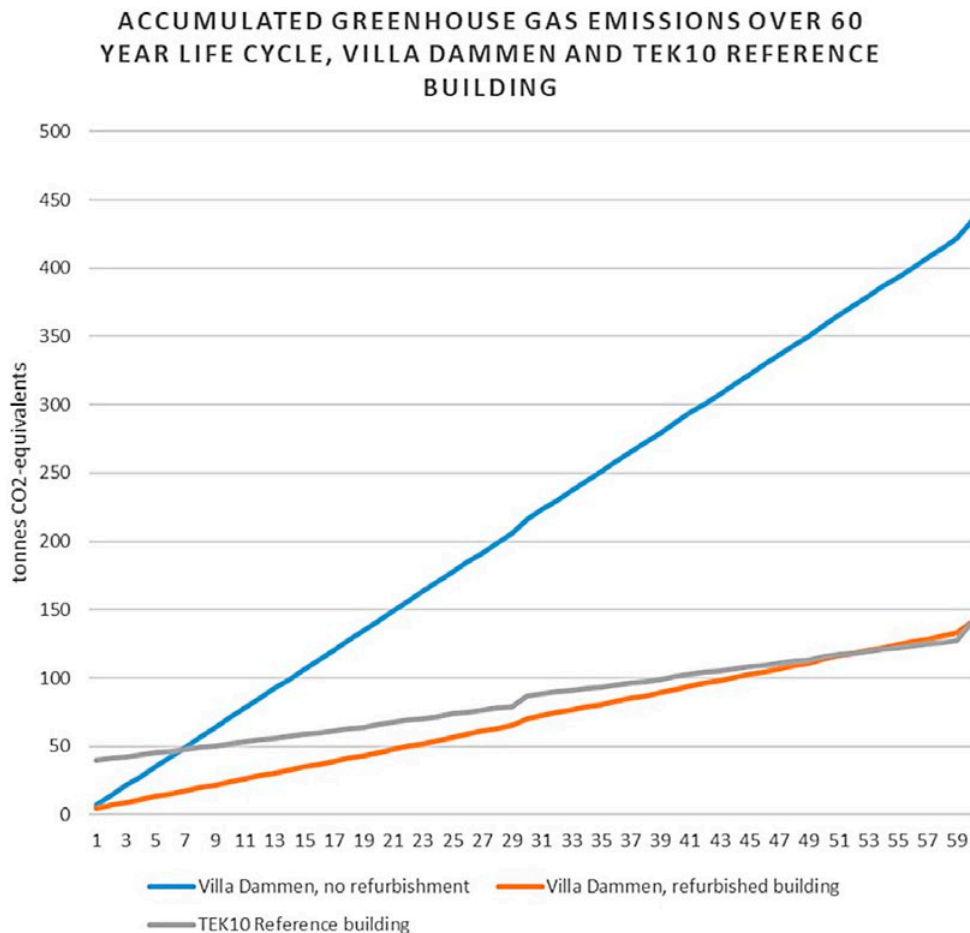

Figure 3. Accumulated greenhouse gas emissions over a 60 year life cycle for Villa Dammen with and without refurbishment, and for the scenario with new construction. Increases in emissions in year 30 are due to modelled maintenance work, while the modelled increase in year 60 is caused by demolition activities.

Figure 3 shows the total GHG emissions for the three scenarios accumulated over the 60-year period of analysis. The intersection between the curves representing Villa Dammen with and without refurbishment is difficult to discern, as it occurs after less than a year (ca. 6 months). The environmental pay-back time of the refurbishment, meaning the time needed for avoided energy emissions due to energy efficiency measures to equal emissions incurred in the upgrade process, is thus very short in this case. Correspondingly, the time needed for the effect on emissions of lower annual energy consumption in the new building to

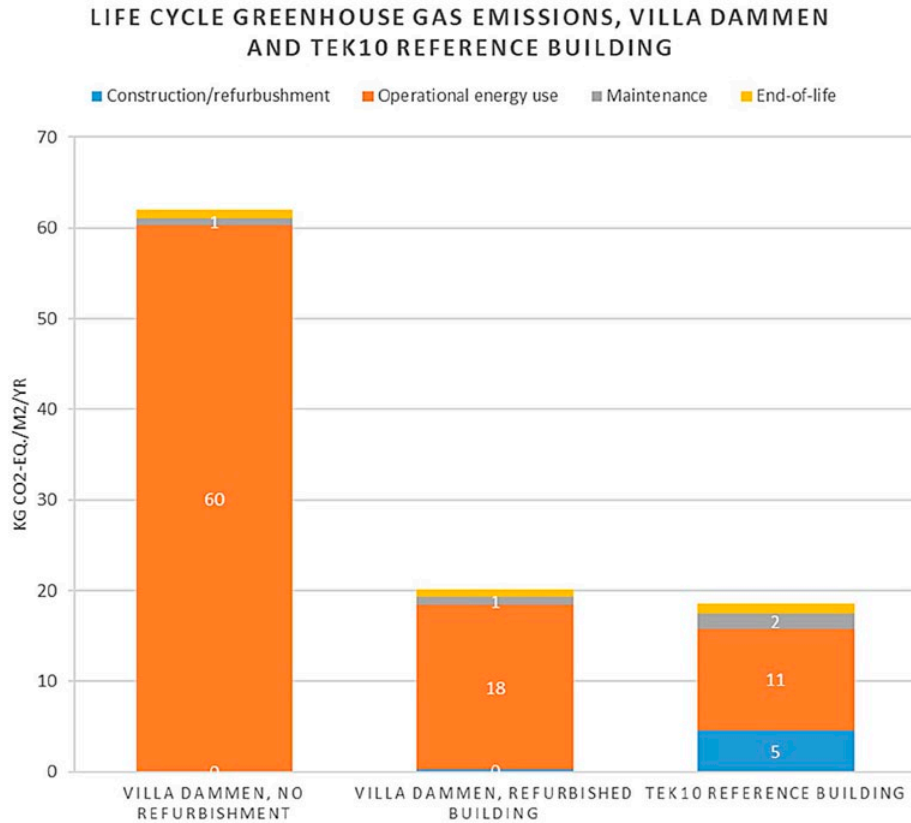

Figure 4. Greenhouse gas emissions related to the production, operation, and maintenance, and end-of-life for Villa Dammen with and without refurbishment, and for the scenario with new construction, per m² heated indoor area per year, over a 60-year life cycle, per life cycle phase

outweigh the emissions caused in the construction process, when compared to the upgraded Villa Dammen, is around 52 years.

Figure 4 shows that emissions related to operational energy use account for the largest share of total emissions in all three scenarios. Thus, energy efficiency measures have a large impact on total life cycle emissions. The energy efficiency measures implemented for Villa Dammen are estimated to reduce operational energy use by ca. 30 %. This corresponds to a 70 % reduction in emissions from energy use, in large part due to the replacement of the oil boiler with a wood burning stove. As wood is considered a renewable energy resource, the incineration of wood is assumed to cause no climate change impact. There is increasing scientific debate regarding the climate change impact of CO₂ released from combustion of biomass, but the implications of this assumption are not further investigated here. The reference building was not modelled with a wood stove as it was intended to represent a standard new building.

Emissions related to electricity consumption account for a very large share of total energy use emissions – ca. 40 % for Villa Dammen without refurbishment, ca. 87 % for the refurbished building, and ca. 97 % for the new building. Actual measured energy use in the refurbished building is almost 50 % lower than the

estimated energy use for the scenario without refurbishment. If measured energy use is used as the base for comparing the refurbished Villa Dammen with the new building, total life cycle emissions are 10 % higher for the new building over the 60-year period of analysis.

Emissions from use of materials in the upgrade process account for only 2 % of total lifetime emissions for the refurbished building. Emissions related to the construction phase are 12 times higher for the new construction than the refurbishment scenario. This reflects the difference in the amount of materials required, the emissions associated with the demolition of the existing building in the new construction scenario, and the type of materials used. Emissions caused by materials for operation and maintenance and demolition phases account for only a small part of total life cycle emissions.

4. DISCUSSION AND CONCLUSION

There are two main points that can be brought forward by this paper. First, the environmental pay-back time of replacing Villa Dammen with a new, more energy efficient building exceeds 50 years. The study confirms that the amount and type of materials used in energy efficiency refurbishment and new construction represent decisive impact on the compared net environmental benefit, both in the short and long term. By using environmentally friendly and locally produced building materials, upgrading measures will cause low GHG emissions, and the historic building is less likely to have its character or qualities reduced. However, knowing that emissions related to the use of construction materials will affect net climate benefits of upgrading a historic building, the everyday homeowner scenario might very well overturn the benefits since it is not normally approached or dealt with in a standardised manner in line with the comprehensive CEN-standard for energy efficiency in historic buildings. The required knowledge of the inherent energy regime of a historic building on the one hand, and long term environmentally friendly solutions on the other hand, is in most cases not that rooted with the public. For homeowners and practicing energy consultants to comply with this broadened approach to energy efficiency the need for more scientific studies exploring and measuring the life cycle approach (via LCA) to building conservation is evident. One way forward to make LCA a useful tool also for historic buildings is by strengthening data on traditional materials and energy systems. Learning from historic constructions and traditional knowledge, e.g. concerning material use and passive solutions, can in turn contribute to how we pursue sustainability today. Another is quantifying and exploring life cycle scenarios for larger existing building stocks. Lastly, we see a potential in educating case officers, e.g. in city planning authorities, in the notion of the life cycle approach.

Secondly, the gap between energy simulations based on standardised user profile data (NS 3031) [12] and the “conscious” user profile is a key issue investigated in the study, and the results from the comparison point to a larger discrepancy between actual and estimated energy use for older buildings than new ones. Users and residents thus clearly play a critical part with respect to

realising the expected energy savings related to upgrading historic buildings. This has been pointed out in several previous studies on energy efficiency in historic buildings, but this is the first time it has been calculated with alternate user profiles. The assumptions on which we based the adjusted modelling scenario could therefore be used to underline the importance of improved energy behaviour of residents in older dwellings, in addition to new buildings in general. Perhaps this can be achieved by raising awareness about historic buildings and their cultural heritage significance in general.

A new low or passive energy building will, under the condition that it outlives the historic building, inevitably recoup its environmental investment costs and overtake the historic building in environmental performance due to its lower operational emissions. This is perhaps, except for an increasing demand of domestic floor space, the strongest argument for constructing new buildings and, from a theoretical point of view, a disadvantage for the comparative case of Villa Dammen. i.e. the long-term perspective favours new buildings. The short-term argument however, aiming to achieve quick results, is supported by the continued use of existing buildings. In practice, and regarding the context of sustainability, a combination is of course to be recommended.

To conclude, the results of the study support that the continued use of historic buildings and the impact of user behaviour should be better advocated for in building codes and environmental policies. The results also show that choosing the “right” solutions when upgrading is crucial in terms of emissions related to material use and energy saving. Energy use and emissions can in other words be significantly reduced if the energy efficiency process is carefully considered and the residents are involved. While the historic segment of the building stock might not be a large contributor to greenhouse gas emissions, compared with other sectors, it is more vulnerable to hastened decisions and should therefore be handled with care.

5. REFERENCES

- [1] Kohler, N. and U. Hassler, *The building stock as a research object*. Building Research & Information, 2002. 30(4): pp. 226–236.
- [2] CEN, *Conservation of cultural heritage – Guidelines for improving the energy performance of historic buildings*, in TC 346, EN 16883:2017. 2017, Comité Européen de Normalisation.
- [3] Elefante, C. *The greenest building is... one that is already built*. in *Forum Journal*. 2007. National Trust For Historic Preservation.
- [4] Ding, G.K.C., *Sustainable construction – The role of environmental assessment tools*. Journal of Environmental Management, 2008. 86(3): pp. 451–464.
- [5] Kohler, N. and U. Hassler, *Alternative scenarios for energy conservation in the building stock*. Building Research & Information, 2012. 40(4): pp. 401–416.
- [6] Fouseki, K. and M. Cassar, *Energy Efficiency in Heritage Buildings – Future Challenges and Research Needs*. The Historic Environment: Policy & Practice, 2014. 5(2): p. 95–100.

- [7] Berg, F., et al., *User-driven energy efficiency in historic buildings: A review*. Journal of Cultural Heritage, 2017. 28(2017): pp. 188–195.
- [8] The Nordic Council of Ministers, *CERCMA : Cultural Environment as Resource in Climate Change Mitigation and Adaptation*. 2014, The Nordic Council of Ministers,; Copenhagen. p. 59.
- [9] Berg, F. *Using the life cycle analysis approach for decision and policy support concerning built cultural heritage: Norwegian case studies*. in *Second International Conference on Energy Efficiency and Comfort of Historic Buildings (EECHB)*. 2016. Brussels: Flanders Heritage Agency.
- [10] Ben, H. and K. Steemers, *Energy retrofit and occupant behaviour in protected housing: A case study of the Brunswick Centre in London*. Energy and Buildings, 2014. 80: pp. 120–130.
- [11] Brohus, H., et al., *Influence of occupants' behaviour on the energy consumption of domestic buildings*. Clima 2010, 2010: p. 9.

The ROT programme, energy efficiency, and historical values in buildings in Sweden

1984–1993

M. Tunefalk and M. Legnér

*Conservation Unit, Department of Art History, Uppsala University – Campus Gotland, Visby, Sweden.
Email: martin.tunefalk@konstvet.uu.se; mattias.legner@konstvet.uu.se*

Abstract – In the early 1980's, the Swedish government launched a home improvement programme (ROT), consisting of loans, grants and information to property owners for modernization of houses older than 30 years. The target was to modernize 425,000 homes during the period 1984–1993. It was a priority that 'energy saving measures must be intensified'.

By studying how ROT was conceived and negotiated in regards to energy efficiency and historical values in buildings, this paper contributes to a better understanding of how housing policies may generate both risks and opportunities. The study reveals a conflict of interest between stakeholders. Discourses regarding the programme shifted widely between interest groups and over time. Initially, it was presented as a solution for unemployment in the building sector, and a social improvement for the poor and elderly. It was not until the late 1980's that a discussion started on the consequences for historical values.

Keywords – policy making; built heritage; energy efficiency; home improvement; Swedish urban planning

1. INTRODUCTION

In 1983, the Swedish government presented a ten-year home improvement programme (ROT) aimed at modernising the building stock in terms of living standard and energy efficiency, as well as decreasing unemployment in the building sector. ROT is an acronym for the Swedish words for Renovation, Refurbishment and Extension, and is still used today for policies aimed at subsidising home improvement. The overarching objective was 'to ensure that all people can live in a modern home'. A secondary objective was that 'measures of energy efficiency must be intensified'. This was to be achieved by making sure that 'all unmodern dwellings shall be liquidated by means of reconstruction, change of use, or demolition' [1, p. 2, 11]. The purpose of the programme was thus formulated as to hinder conservation of historical values in the building stock. Modernization, including energy efficiency, and conservation were conveyed as opposites.

The programme consisted of both financial and informational instruments. The financial instruments entailed governmental housing loans for refurbishments, interest subsidies for measures of home improvement and energy efficiency (paid directly from the state to the lender), and dedicated energy efficiency

subsidies for improvement of heating systems, additional insulation and improved energy efficiency of windows [2], [3]. A large part of the measures funded by the programme was targeted at energy savings [4, p. 13]. The informational instruments consisted of extensive information campaigns on refurbishment techniques as well as available funding [2], [3], [5]–[8].

Although scarce, previous research has concluded that ROT, especially during its early years, had a negative impact on the historical values of the built environment [9, pp. 230–231], [10, pp. 279–282]. Despite its extensive ambitions, the impact on energy savings have also been questioned [10, p. 281]. Despite these obvious flaws, the programme was renewed after the initial ten-year period. In fact, although the framework has changed, ROT still today is an extensive programme affecting buildings, energy efficiency and historical values on a national scale.

This paper presents novel results by examining ROT from an historical point of view for the first time. By placing ROT within a wider context, the ambition is to understand the factors in play when policies on energy efficiency are shaped and implemented. In the policy making process, the concepts of energy efficiency and conservation were connected and erratic, changing over time and between agendas. The source material is threefold and consists of: 1) governmental official decisions, propositions and communication; 2) newspaper articles and public statements from interest groups; and 3) contemporary scientific reports and evaluations of the programme.

2. INTRODUCING THE PROGRAMME

Following a period of unprecedented building in the 1960's and 1970's, the newly elected Social democratic government of Sweden decided in 1983 on a programme to promote refurbishments of older buildings. The country suffered from a stagnating economy and growing unemployment. The building sector represented a considerable part of the unemployed. The political focus shifted from construction to upgrading existing dwellings that were considered small, energy inefficient, and uncomfortable. The objective was to improve 275,000 apartments and 150,000 small buildings until 1993 [1, p. 2]. The purpose of this was two-fold: to modernize the building stock, and to increase the employment rates in the building sector [2, p. 27]. A 'declaration of human rights of housing' was formulated in six articles.

The Minister of Housing, Hans Gustafsson, said in October 1983 that

'a prime objective for the programme is to ensure that everybody gets to live in a modern home. This means that all unmodern apartments will be refurbished, put to other use, or be demolished. Today 9,000 construction workers are unemployed. The intention of the programme is to decrease that number'[11].

In connection to its introduction, the ROT programme was expanded to include buildings owned by the local municipalities, such as schools and hospitals. The Minister of Housing said that 'the maintenance of these buildings is often neglected and a refurbishment would result in thousands of jobs in the buildings

sector' [11]. He highlighted that the governmental support to the municipalities was to be seen as a pure incentive to stimulate the building sector and claimed that an advantage with targeting buildings owned by local and regional municipalities was that those projects were favourable for the contractors. This would attract larger companies that could ensure long term employment [12]. The builders' union had big expectations on the ROT programme and welcomed its extension [12]. Needless to say, the union was supportive of plans to increase the employment in the sector. They saw it as a first, but too small, step towards that end [13], [14].

The ROT policy statement relates throughout to the issue of energy efficiency. In 1978 and 1981, the parliament had decided on a plan to reduce the energy consumption in buildings with 30 percent in ten years. The statement notes that such an extensive reduction will require extensive measures, such as additional insulation on exterior walls [1, p. 13]. According to the statement, most multi-dwelling residences built before 1960 had exterior walls with poor thermal insulation. Buildings from 1931–1945 were perceived to be the worst energy wasters, with unsatisfying insulation in 80 percent of the stock. In these buildings, additional exterior insulation was considered a pressing solution. This measure was also stressed for buildings from before 1930 and from 1945–1960 [1, p. 47]. The most urgent need was seen in façades of plaster [1, p. 216]. Very few houses built before 1975 were considered to fulfil the demands for new buildings. The conclusion was that 'if the decided targets for energy savings are to be reached, the insulation of the exterior walls in multi-dwelling buildings must be improved' [1, p. 215]. A qualification for governmental funding within the programme was that measures for home improvement were coordinated with energy saving measures [15, p. 59], [16, p. 3–4].

The Social democratic party came to power in 1982, following four years of centrist/liberal government. The Social democrats had dominated Swedish politics since the 1930's. When they resumed power, in a slow economy on top of it all, it is likely that they had a will to show initiative. The political significance of the project is underlined by the fact that that prime minister Olof Palme presented the idea in his initial speech [17, p. 50].

Immediately after its introduction, the programme was subjected to heavy critique from different actors and parts of society, and for different reasons. The collectively owned property company *Riksbyggen* was critical to the programme for targeting the wrong buildings and claimed that it mainly benefitted privately owned properties [18]. A senior manager at The Board of Housing said in *Dagens industri*, the biggest financial newspaper in the country, that the programme would *reduce* subsidies, with the risk of slowing the sector down [19]. The same newspaper had in October 1983 the headline 'The ROT programme kills entire sector'. The article referred to a prognosis for the market for heat pumps, that in the initial draft for the programme were left out of subsidies [20]. The association of property owners was critical to the programme for requiring too much monitoring by the municipalities [21]. The liberal and right-wing parties anticipated additional bureaucracy and accused the government of ignoring relevant

critique [22]. They also anticipated that the effect on the unemployment would be less than the government said. A representative of the conservative party criticized the programme for resting on subsidies and loans, and claimed that the responsibility for refurbishment and maintenance must rest on the property owner [22]. None of the critique referred to the risk of compromising historical values.

3. A SOLUTION TO UNEMPLOYMENT

The critique against inefficiency in creating employment came to naught in 1984. Shortly after the introduction, the programme proved indeed efficient in this particular regard. During 1984 and 1985, the extent of the programme was a success widely exceeding initial expectations [23, p. 83]. The news agency TT (*Tidningarnas telegrambyrå*) highlighted the positive effects: 'For three months in a row unemployment among construction workers is declining. The ROT programme [...] is starting to show results. During the first four months this year, applications for loans increased with 41 percent' [24]. In October TT reported that applications for refurbishments in Gothenburg had increased with 80 percent in comparison with 1983. In a row of other regions as well, the housing committees expected an increased demand for construction workers, due to ROT [25]. In August, it was announced that unemployment in the sector had decreased from 8 to 5 percent since the introduction of the programme. The Department of Housing said in October, that it was now up to the municipalities and private property owners to take advantage of the financial opportunities that the programme provided, underscoring that the objective was employment for an additional 6,000 construction workers [25].

4. EXCESSIVE REFURBISHMENTS AND HISTORICAL VALUES

In 1986, The Board of Housing published an evaluation of the programme. The report was in many regards positive, but it criticized ROT for having encouraged unnecessarily extensive refurbishments [4]. This became the start of a debate on the programme's effects on social and cultural values. According to the evaluation, the financial structures of the programme had led to property owners making larger refurbishments than needed. Large measures were more economical due to the design of the regulations [4, p. 15].

Tenants were complaining that they were forced to move when the landlord decides to make a total refurbishment instead of maintaining the property. Since the rents were regulated and calculated from the standard of the apartment, the tenant faced a sometimes twice as high rent on moving back in. The governmental loans and subsidies were blamed for this, since they made it more lucrative to refurbish than to maintain [4, p. 4], [26]–[28].

Additional insulation and installations of heat recovery systems in old buildings changed the character of the buildings, both interior and exterior [23, pp. 48–49]. During the first years, c. 50 percent of the approved costs went to energy saving measures (c. 3 billion SEK). About half of these measures were issues of building construction, probably additional insulations. Additional wall-insulation were mainly made in buildings erected before 1960 while insulation in the system of

joists mainly was made in buildings erected between 1945 and 1975. Houses from 1961–1975 dominated measures for improving the energy efficiency of windows [4, p. 13].

The professional association *Swedish architects*, claimed that historically valuable buildings were destroyed with the use of governmental funds. Refurbishments were carried out that contradicted the original idea behind the buildings, with no consideration to historical values. This was derived from the funding of refurbishments, as it was regulated in ROT. Property owners obtained governmental funding for total refurbishments but not for cautious renovations. The result was expensive retrofits of buildings, that were profitable only because of the governmental loans and subsidies. As a bonus they could raise the rents of their tenants and make an additional profit [29], [30].

The government acted on the criticism. In November 1986, the Department of Housing presented a proposition targeted at limiting the unnecessarily extensive refurbishments. The new regulations were effectuated on 1 January 1987 [31, pp. 2, 4]. Thus, the rendered critique had effect on the formal decision-makers. There was an ongoing negotiation between values at hand. In 1987 a new legal statute was introduced ('Plan- och bygglagen'), which included a general demand for precaution when altering a building. In 1988 similar demands were included in the building norm [32], [10, p. 291].

5. LIMITATIONS OF THE PROGRAMME

During the late 1980's focus in the housing sector shifted once again, this time from maintenance and refurbishment to an increased construction. The credit market was deregulated and constructions received interest grants. Unemployment was no longer a problem. On the contrary, the building sector showed signs of overheating. The ROT programme had made it possible for contractors to increase their rates. Meanwhile, discontent with the lack of small inexpensive apartments grew in the larger cities [4, pp. 9–10]. An objective with ROT had been to remove all small apartments. After years of implementing this policy, the number of small apartments in Stockholm was declining. The removal of small apartments equalled half of the construction in a time of an imminent housing shortage [33, p. 49], [34], [35]. In this situation the government decided to limit refurbishments in the three large city areas (Stockholm, Gothenburg and Malmö). The government approved a limit for refurbishments to 50 percent of the levels of 1986 [36], [37].

When the auditors of parliament evaluated the programme in 1989, they deemed it unpredictable and complicated [38, p. 17]. At the time of the evaluation, the programme was still formally active, but because of limitations made in 1988, the auditors considered it questionable if it still existed in practice [38, p. 18]. Another problem with the programme, according to the auditors, was that the regulations for loans were strongly articulated, but the building regulation was not. The result was that the regulations for loans became governing [38, p. 17]. The evaluation attracted attention in media [39], [40].

6. A NEW BEGINNING (DÉJÀ VU)

In early 1993, the newspapers started reporting on a political interest in a new ROT programme. Both liberals and social democrats were arguing for this on the basis of unemployment in the building sector. The president of The Finance Committee, Per-Ola Eriksson, was sure a new programme was due [41], [42].

The new programme was introduced in 1993 and consisted of large investments to stimulate refurbishments of homes and public buildings, such as schools, hospitals and nurseries. It also included a tax deduction of 30 percent of the labour cost for refurbishments in small houses and apartment buildings. This was expected to produce 30,000 jobs in the building sector [43], [44].

Just as in 1983, the builders' union was quick to follow up on political statements in favour of the sector. The chairman of the union, Åke Wänman, claimed in *Dagens nyheter* that the state and municipalities could earn 5 billion SEK by subsidized refurbishments. This by decreasing the expenses of unemployment benefits, while at the same time increasing the tax revenues. Wänman especially noted that there was room for improvement in many older buildings, which also could increase the rental revenue for property owners [45].

Thus, many of the arguments that had been seen in 1983, returned ten years later, even though they had been proved problematic. Once again, the focus lay on reducing the unemployment in the building sector and thereby benefit the governmental budget. And once again the older building stock was targeted. That the same arguments recurred ten years later suggests that the first ROT programme was problematic in the long run. It had no long-term impact on the unemployment, perhaps on the energy efficiency, and most likely on the built heritage.

7. CONCLUSIONS

Between 1984 and 1988, the ROT programme was a far-reaching home improvement policy, originated in a strong belief in political intervention and economic governance. Major measures were taken in the building stock. Additional insulation and changing of windows were common measures funded by the programme. In its initial phase, cultural values were not part of the discussions of the programme, neither from its advocates nor from its critics. This study reveals a negotiation between different interests among a wide range of groups, i.e. politicians, unions, building companies, property owners, etc. ROT was initially presented as a solution to a widespread unemployment in the building sector, as well as a social improvement for the poor and elderly. The programme faced heavy critique from the very start, questioning its efficiency as a remedy for unemployment, the part of the building stock targeted, its scope, its bureaucratic shape, etc. But the impact on the built environment was not under debate during the first intensive years. During this period, national economy and supposed social consideration were evidently valued higher than cultural values at hand. The result was unnecessarily extensive measures, directed more towards creating jobs than to consider the built heritage.

ROT was in the public debate used as a solution in many different issues, such as home improvement, energy efficiency, unemployment, equality, old age care, and informal economy. It has been mentioned in regard to policies on housing, labour, finance, energy and social care. The purposes of the programme shifted in the discourse, both over time and between agents. The same politicians that in 1983 advocated that all unmodern apartments should be refurbished or demolished, claimed just a few years later that precaution of the cultural values was the main purpose of the programme – even though the original programme statement clearly stated that the objective was to create job-opportunities by reduce the number of unmodern homes. Hence, changes of the programme, both discursive and financial, took an organic form through a constantly ongoing negotiation, a negotiation that occurred simultaneously on all levels of society, from national politics to the individual family, deciding on renovating their home. In this negotiation, energy efficiency as well as historical values were used as arguments to achieve change. Ideas about cultural values, though vague and abstract, could have real effect on politics. When criticism was made regarding the programme's impact on the built heritage, it led to changes in its financial structures. On the one hand, the programme did cause a lot of irreversible change to the built environment. In the first years, excessive refurbishments were common. The residents often testified to changes that had negative impact, for both social and cultural values in the area. On the other hand, measures included in the programme can be seen as conservation of sorts, though not as preservation. There is a possibility, considering low standard, bad insulation and neglected maintenance, that some of the buildings would face demolition if not refurbished. The act of conservation can include modifications and amendments to the object.

This paper has shown that the concepts of energy efficiency and conservation are connected, organic and changeable, as well as influential in a larger political discourse. The Social democratic government that initiated ROT had a strong belief in what needed to be done, and how. It also had a clear priority between values at hand: the national finances were to be stimulated by modernizing the building stock. The programme statement, as well as leading politicians, articulated an opposition between conservation on the one hand and energy efficiency and modernization on the other. Old values had to make way for new ones. It was not the will to modernize that was the problem in regards to cultural values. Rather, it was the notion that the two concepts were incompatible. If policies are correctly formulated, modernization, energy efficiency and conservation do not need to contradict each other. This paper suggests that they are not only compatible, but constantly entangled. After the programme had subsided it only took a few years before decision-makers saw new incentives to support the building sector. In the early 1990's, arguments for a far-reaching home-improvement programme were raised once again, with a discourse highly similar to that ten years prior.

8. REFERENCES

- [1] Ds Bo 1983:2: Bättre bostäder: ett 10-årigt förnyelse- och underhållsprogram (ROT-program). Stockholm, 1983.
- [2] Lån och bidrag till förbättring av flerbostadshus. Stockholm: Bostadsstyrelsen, 1986.
- [3] Lån och bidrag till förbättring av egnahem. Stockholm: Bostadsstyrelsen, 1987.
- [4] Bostadsstyrelsens utvärdering av bostadsförbättringsprogrammet Stockholm: Bostadsstyrelsen, 1986.
- [5] Utbildningsmaterial för bostadsförbättring: ytterväggar. Stockholm: Bostadsstyrelsen, 1986.
- [6] Utbildningsmaterial för bostadsförbättring: värme, sanitet. Stockholm: Bostadsstyrelsen, 1987.
- [7] Utbildningsmaterial för bostadsförbättring: fönster. Stockholm: Bostadsstyrelsen, 1987.
- [8] Utbildningsmaterial för bostadsförbättring: el. Stockholm: Bostadsstyrelsen, 1987.
- [9] Nylander, Ola. Svensk bostad 1850–2000. Lund: Studentlitteratur, 2013.
- [10] Schönbeck, Boris. Stad i förvandling. Uppbyggelseepoker och rivningar i svenska städer från industrialismens början till idag. Stockholm: Statens råd för byggnadsforskning, 1994.
- [11] Tidningarnas telegrambyrå 1983-10-22.
- [12] Tidningarnas telegrambyrå 1983-12-16.
- [13] Tidningarnas telegrambyrå 1983-09-22.
- [14] Tidningarnas telegrambyrå 1983-10-10.
- [15] Ds Bo 1984: 11: Vidgad rådgivning för energihushållning och bostadsförbättring. Stockholm, 1984.
- [16] Myndigheternas ansvar för energihushållningen i bebyggelsen. Stockholm: Bostadsstyrelsen, Statens energiverk & Statens planverk, 1984.
- [17] Riksdagens protokoll 1982/83:6.
- [18] Tidningarnas telegrambyrå 1983-09-14.
- [19] Dagens industri 1983-08-25.
- [20] Dagens industri 1983-10-03.
- [21] Tidningarnas telegrambyrå 1983-10-13.
- [22] Tidningarnas telegrambyrå 1983-12-13.
- [23] Vidén, Sonja (ed.). Bättre bostadsförnyelse. Sammanställning av slutsatser från 19 FoU-projekt. Karlskrona: Boverket, 1990.
- [24] Tidningarnas telegrambyrå 1984-06-20.
- [25] Tidningarnas telegrambyrå 1984-10-16.
- [26] Tidningarnas telegrambyrå 1986-05-28.
- [27] Tidningarnas telegrambyrå 1986-03-05.
- [28] Tidningarnas telegrambyrå 1991-07-25.
- [29] Tidningarnas telegrambyrå 1986-02-20.
- [30] Tidningarnas telegrambyrå 1985-08-31.
- [31] Regeringens proposition 1986/87:48 om bostadspolitiken.
- [32] Plan och bygglagen, 13 kap, 13 §.
- [33] Bättre koll på underhåll. Karlskrona: Boverket, 2003.

- [34] Dagens industri 1987-06-11.
- [35] Tidningarnas telegrambyrå 1986-10-27.
- [36] Tidningarnas telegrambyrå 1986-11-04.
- [37] Tidningarnas telegrambyrå 1987-03-28.
- [38] Försl. 1989/90: 13: Riksdagens revisorers förslag angående 1983 års bostadsförbättringsprogram.
- [39] Tidningarnas telegrambyrå 1989-10-13.
- [40] Tidningarnas telegrambyrå 1990-03-20.
- [41] Dagens nyheter 1993-02-12.
- [42] Tidningarnas telegrambyrå 1993-02-19.
- [43] Dagens nyheter 1993-03-11.
- [44] Tidningarnas telegrambyrå 1993-03-24.
- [45] Dagens nyheter 1993-02-22.

Energy Performance Certification

Is the software currently used in Malta suitable for the energy assessment of its historic buildings?

M.R. Mallia¹ and O. Prizeman²

¹ Welsh School of Architecture, Cardiff University, Cardiff, UK. Email: mroberta.mallia@gmail.com

² Welsh School of Architecture, Cardiff University, Cardiff, Wales, UK. Email: prizemano@cf.ac.uk

Abstract – The aim of this study is to assess whether the official Maltese software used for Energy Performance Certifications for Non-Dwellings, Simplified Building Energy Model (SBEM), is suitable for the assessment of historic buildings. The study takes into consideration two Maltese historic non-dwellings, Auberge de France, Birgu and Casa Rocca Piccola, Valletta, which were modelled using quasi-steady-state software (SBEM) and dynamic software (DesignBuilder®). Results from the two models were compared between themselves and with actual energy consumption. These comparisons indicated that SBEM over-estimates the energy usage in historic buildings. Results obtained from dynamic simulation approached the actual consumption closer, although discrepancies were noted. It is recommended that historic buildings are assessed using a proposed hybrid software which allows for the dynamic nature of the building's thermal performance whilst having partially fixed datasets to improve reproducibility. When possible this should be substantiated by the Operational Rating of the historic building.

Keywords – Energy Performance Certification (EPC); energy performance of historic buildings; dynamic simulation; Simplified Building Energy Model (SBEM); asset vs operational rating

1. INTRODUCTION

1.1 ENERGY PERFORMANCE CERTIFICATION

The Energy Performance of Buildings Directive (EPBD) aims to improve the overall energy performance of buildings. One of its main targets is to establish an energy audit and certification system for buildings, known as Energy Performance Certificates (EPCs) [1].

EPCs assess the energy performance of buildings and rate them on a scale depending on their Asset Rating. When calculating energy performance, the pre-established National Calculation Methodology (NCM) is adopted [1] to ensure comparability and reproducibility. In most European Member States, the calculation methodology has taken the form of a software package [2], which may be classified into three types [3]:

- Steady-state models, which assume steady conditions;
- Quasi-steady-state (QSS) models, which assume a constant average temperature for the calculation period. Utilization factors are used to account for thermal storage;

- Dynamic models, which take into consideration sub-hourly time steps to reflect the continually changing conditions within the building. These yield results that are more accurate but they are more complex, time-consuming and costly to run.

1.2 LIMITATIONS OF ENERGY PERFORMANCE CERTIFICATIONS

One of the main limitations of EPCs relates to the discrepancy between the estimated performance of a building and its actual performance [4]. This discrepancy is attributed to a number of factors including the type of software used. Studies have shown that different types of software yield different results and they attribute this discrepancy to the algorithms which are inherent to the calculation methodology employed [5].

1.3 ENERGY PERFORMANCE OF HISTORIC BUILDINGS

Historic buildings were originally designed to exploit passive design measures to provide internal comfort conditions [6]. The heavy reliance on passive systems would suggest that historic buildings perform favourably in terms of energy demand. Studies [7, 8] indicate that historic buildings out-perform expectations and in some cases they also out-perform recent buildings. Notwithstanding this, there is a general perception that historic buildings are energy inefficient. This makes them undesirable and may also lead to unnecessary retrofit measures which may cause irreparable damage to the historic fabric of the building [6]. These misconceptions may be partly attributed to inaccurate EPCs.

1.4 ENERGY PERFORMANCE CERTIFICATIONS IN HISTORIC BUILDINGS

Surveys carried out indicate that EPCs for historic buildings have a high Standard Assessment Procedure (SAP) rating [8], suggesting that historic buildings are energy inefficient and that their high operational energy levels reduce the benefits achieved by saving on embodied energy. Studies [7, 10] indicate that EPCs grossly over-estimate energy consumption of historic buildings, in some cases by as much as 40 % more than the actual energy consumption. This discrepancy may be attributed to the fact that the software used to calculate EPCs does not take into consideration the complex dynamic performance of historic buildings, ultimately leading to erroneous results.

2. CASE STUDY IN MALTA

2.1 GEOGRAPHICAL LOCATION AND CLIMATE

This study is based in Malta, a small archipelago in the Mediterranean Sea, located to the south of Sicily. The Köppen-Geiger climate classification categorizes the Maltese climate as Csa, a temperate climate with long, hot summers and mild, wet winters [11].

2.2 MALTESE ARCHITECTURE

2.2.1 Construction Materials and Methodologies

Lower Globigerina Limestone (LGL) was used for the construction of walls and of roofs due to the fact that historically it was the only naturally occurring construction material. LGL has a high total porosity (32–41 %) [12], a density of 1700 kg/m³ and a thermal conductivity of 1.1 W/mK [13]. However, given its high total porosity and the effect that moisture content may have on thermal conductivity, the latter value may fluctuate.

In historic buildings up until the end of the 19th Century, external walls generally consisted of a massive, two leaf construction. The central cavity was either filled with un-compacted masonry chippings and soil (cavity > 100 mm) or else left empty (cavity < 100 mm). Internal walls consisted in single leaf construction with an average thickness of 300 mm. Roofs consisted in LGL slabs supported by masonry arches or timber beams. The exposed roof had a final waterproofing layer, which consisted in a compacted mixture of crushed pottery, lime and water [14].

2.2.2 Bio-Climatic Features

Due to the long hot summers, a greater emphasis was given to cooling. Up until the 17th Century, buildings had a more introverted nature and had minimal openings on the external façades in order to minimize external heat gains. On the other hand, later buildings had larger openings on their façades and these were shielded by the introduction of external timber louvres that provided shade yet still allowed ventilation [14].

The use of massive construction coupled with natural ventilation was considered an optimal way to maintain thermal comfort. To this effect, one main feature which remained in use throughout the various historical periods was the central courtyard that would provide cross ventilation and shading to the habitable rooms by means of loggias. Other commonly found bioclimatic features include high ceilings and later on the use of ventilation stacks.

2.3 ENERGY PERFORMANCE CERTIFICATIONS IN MALTA

For official EPC assessment purposes, buildings in Malta are categorized into dwellings and non-dwellings, each requiring a different software. Non-dwellings, which are assessed in this study, require the Simplified Building Energy Model (SBEM) which is a QSS model.

3. AIMS

The aim of this study is to determine whether the officially recognized software currently used by registered assessors in Malta to carry out EPCs for Non-Dwellings (SBEM) is suitable for the assessment of historic buildings and whether it is adequately representing their energy usage in specific cases.

A secondary aim is to assess different simulation model typologies (steady-state/QSS and dynamic state) in order to evaluate their suitability when compared with actual energy consumption readings.

4. METHODOLOGY

4.1 CASE STUDIES

This study focussed on two local non-dwellings (Figure 1), namely:

- *Auberge de France* in *Birgu*, which dates back to 1533 and is currently being used as a local council (offices);
- *Casa Rocca Piccola* in *Valletta*, which dates back to 1580 and houses a privately owned museum at the upper levels and a restaurant at ground and basement level.

These were chosen because their original construction is mostly intact and because they each still operate as an individual interconnected unit.



Figure 1. (a) Location of Case Studies (b) Auberge de France (c) Casa Rocca Piccola.
Source: (a) Google Earth (b,c) Author.

4.2 RATIONALE

In order to determine their official EPC rating, the two case studies were assessed using SBEM, the only local official software available to calculate EPCs. To assess whether discrepancies arise between results obtained from dynamic and QSS models, the case studies were also modelled using dynamic simulation software, *DesignBuilder*[®], a graphical user interface for the dynamic simulation engine *EnergyPlus*[®].

The results obtained from both simulations were compared with the actual metered energy consumption in order to ascertain which type of simulation results approach closer to the actual consumption.

4.3 CREATING THE MODELS

4.3.1 Ensuring Comparability and Reproducibility

In order to ensure that an optimal comparison was achieved, it was essential that the two models were as similar as possible. Hence, input parameters were kept constant between the two software packages. Data forming part of SBEM's lockable library was replicated in the *DesignBuilder*[®] data input.

4.3.2 Geometry and Zoning

Detailed survey drawings of the two buildings were consulted to determine the overall areas, dimensions and the size and location of each aperture. Zoning and dimensions were taken in accordance with SBEM guidelines [15] and were replicated in the *DesignBuilder*® model.

4.3.3 Weather Data

SBEM makes use of a locked weather database with standard weather data. As the pre-set weather data in *DesignBuilder*® does not include the hourly data required to run simulations using the *EnergyPlus*® interface, a new weather dataset, including hourly data, was produced using *Meteonorm*®. This was compared with statistical weather data for the Maltese islands [11] in order to ensure its accuracy.

4.3.4 Building Fabric

Both buildings had been constructed similarly using traditional Maltese materials and construction techniques. Walls and roofs both consist of LGL elements. Details of the building elements are given in Figures 2 and 3.

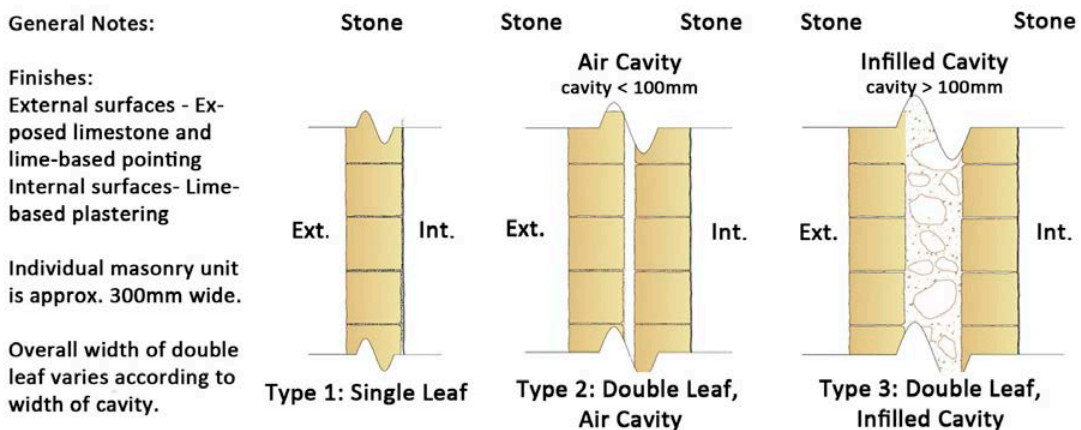

Figure 2. Typical wall types found in case studies. Source: Author.

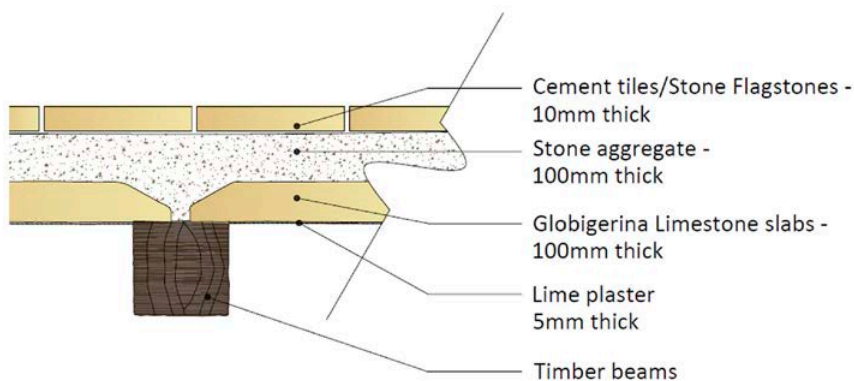

Figure 3. Typical intermediate ceiling. (For top roofs the cement tile layer would be substituted by a 10 mm crushed pottery mix; a 4 mm bituminous layer was added in more recent times.) Source: Author.

Apertures in both case studies consist of timber elements with single glazing. The default value found in SBEM was used for both models as this was thought to be more representative of local timber windows.

4.3.5 Services

Lighting and Heating Ventilation and Air-Conditioning (HVAC) installed in the two case studies were noted and included in the two models. Technical literature for the installed services was consulted when possible. However when this was missing, default SBEM values were used for both models, as these were thought to be more representative of typical local services.

4.4 CHANGES IN OCCUPANCY AND USAGE

Schedules for occupancy, lighting and HVAC are part of the lockable library in SBEM and are based on CIBSE guidelines [16]. To enable comparison of SBEM results with those obtained from the dynamic model, these were kept constant even in the dynamic model. In order to assess whether dynamic models are more suited to evaluate energy consumption in historic buildings, another dynamic simulation was run, this time using actual timeframes and occupancy rates to reflect the actual usage of the building. This second simulation (Dynamic Model Modified, DMM) was carried out only for the *Auberge de France* because it functions as an office and therefore has a more regular usage pattern.

4.5 COMPARISON WITH ACTUAL CONSUMPTION

Results obtained from the two simulations were compared with actual consumption in order to determine which simulation yielded the more accurate results. This comparison was carried out for *Auberge de France*. The electricity bills provided for *Casa Rocca Piccola* were incomplete. Therefore for the purpose of this paper, only the comparison for the former case study will be presented.

Table 1. Energy Consumption

Model Type	Energy Consumption (kWh p.a.)						
	Room Electricity	Lighting	Heating	Cooling	Domestic Hot Water	Auxilliary	Total
<i>Auberge de France</i>							
SBEM	n/a	30,096.7	3446.2	3330.4	3062.5	0.0	39,935.8
DesignBuilder®	12,604.7	13,884.5	633.3	2354.8	864.9	n/a	30,342.2a
DMM	8239.1	13,608.4	380.1	1771.9	864.9	n/a	24,864.4a
<i>Casa Rocca Piccola</i>							
SBEM	n/a	88,973.5	32,055.7	14,600.3	18,456.6	2521.4	156,579.6
DesignBuilder®	22,854.3	35,385.4	18,927.5	14,840.1	254.9	n/a	92,262.2a
^a DesignBuilder® models include room electricity whereas SBEM models do not.							

Table 2. EPC Asset Rating

Case Study	kgCO ₂ /m ² p.a.			EPC Band		
	SBEM	DesignBuilder®	DMM	SBEM	DesignBuilder®	DMM
Auberge de France	199.4	118.2	96.7	D	C	B
Casa Rocca Piccola	145.4	72.1	n/a	C	B	n/a

5. RESULTS

By comparing the results obtained, it is clear that QSS results indicate a significantly higher energy usage than those obtained from the dynamic models. Both the default QSS and dynamic simulations indicate a higher energy consumption than the results obtained by the DMM. Table 1 gives a complete comparison of the results obtained from all the simulations.

The results obtained from the official EPC software SBEM are more than twice the actual consumption for Auberge de France. The results from the default dynamic simulation are still quite high, whereas DMM results approach the actual consumption (Table 3).

Table 3. Simulation Results vs Actual Consumption

Actual Consumption: 16,160 kWh p.a.		
Model	Calculated Results (kWh p.a.)	Difference Factor
SBEM	39,935.8	x 2.5
DesignBuilder®	30,342.2	x 1.9
DMM	24,864.4	x 1.5

6. CONCLUSIONS

6.1 SOFTWARE SHORTCOMINGS

It is clear that different simulation models yield different results. QSS models clearly over-estimate energy consumption, possibly due to a number of inherent flaws, including:

- their simplistic nature, which does not consider the dynamic behaviour of buildings;
- the exclusion of an ability to recognise the contribution of passive systems, which inevitably leads to incorrect certifications, especially when considering that historic buildings rely heavily on such passive systems.

Some shortcomings were observed in both software packages. The use of default values and standard data invariably leads to incorrect results. Historic buildings are by their very nature very diverse from each other and so the use of standard or default data may not be appropriate.

Another shortcoming is the fact that neither software package accounts for the actual condition of the building. This is well documented to have a considerable bearing on the thermal performance of a building. *DesignBuilder*[®] allows for a crack template to mimic air infiltration from unkept walls. However, the quantification of this condition is very subjective and should be measured using air-tightness values.

Furthermore, neither software package considers the moisture content and the permeability of the building materials. This is a very important factor in historic buildings as the dynamic behaviour of moisture not only affects the insulation properties of the masonry wall but also affects the radiant temperature of the surfaces. This ultimately affects thermal comfort within the building impinging directly on the amount of energy consumed for heating and cooling.

6.2 RECOMMENDATIONS

From the results obtained it is evident that the official EPC software SBEM is not an ideal method to carry out energy audits or issue EPCs for historic buildings as it grossly over-estimates energy usage, potentially leading to devastating results in terms of decision making that affects the conservation of historic built fabric. The use of dynamic models is better suited to assess historic buildings, although further similar studies should be carried out to ascertain the behaviour of dynamic models vis-à-vis actual energy usage.

However, it is clear that in order to routinely carry out such detailed, dynamic models would be a very arduous task. The inclusion of so many different variables might well increase the risk of human error and reduce the potential for reproducibility, which is a key element set out in the EPBD.

To make up for these limitations, a compromise between the two types of software would be ideal. The model should be based on dynamic calculations but should have a controlled data-set for certain parameters. This would be especially viable for places such as Malta, in which a single building material has been so widely used historically in the construction of its buildings. Due to the variation in building fabric, the material properties should still be input manually, and hygrothermal simulation may also be included. The latter should be used with caution as moisture content fluctuates over time and even between one area of the wall and another. Occupancy and schedules could possibly be catered for by means of drop-down menus to include multiple standard options to better reflect current conditions. One may opt to model the building using Adaptive Comfort Standards rather than Predicted Mean Vote Standards, especially in view of the heavy reliance of historic buildings on passive design measures.

If, however, actual energy consumption readings are available, the energy audit should also take note of this and use the Operational Rating. This should substantiate the Asset Rating in order to obtain a more holistic representation of the energy efficiency of the building.

7. REFERENCES

- [1] Directive 2010/31/EU of the European Parliament and of the Council of the 19th May 2010 on the Energy Performance of Buildings.
- [2] International Energy Agency. (2010, November). Energy Performance Certification of Buildings: A policy tool to improve energy efficiency. [Online]. Available: https://www.iea.org/publications/freepublications/publication/buildings_certification.pdf [20th January 2018].
- [3] B.D. Hunn, Fundamentals of Building Energy Dynamics. Cambridge USA: MIT Press Ltd., 1996, p. 226.
- [4] P. de Wilde and R. Jones. (2014, April). "The building energy performance gap: up close and personal". Session 9, Paper 2, CIBSE ASHRAE Technical Symposium, Dublin, Ireland, 3–4 April 2014. [Online]. Available: <http://www.cibse.org/knowledge/cibse-technical-symposium-2014/the-building-energy-performance-gap-up-close-and-p> [Accessed 10th December 2015].
- [5] V. Ingram, P.F.G. Banfill and C.J. Kennedy. "Towards an objective assessment of energy efficiency in heritage buildings". Proceedings of the World Renewable Energy Congress 2011, 57 ed., Vol. 8, 2011, pp. 2018–2025.
- [6] M. Suhr and R. Hunt, R. Old House Eco Handbook: A Practical Guide to Retrofitting for Energy-Efficiency & Sustainability. London: Francis Lincoln Publisher, 2013, p. 10.
- [7] J. Wallsgrove. (2008, March). "The justice estate's energy use". Context. [Online]. Issue 103, pp. 19–20. Available: http://ihbc.org.uk/context_archive/103/wallsgrove/page.htmlbake [20th January 2016].
- [8] P. Baker. 2011. (2008, October). Historic Scotland Technical Paper 10: U-values and traditional buildings In situ measurements and their comparisons to calculated values. [Online]. Available: <http://www.historic-scotland.gov.uk/hstp102011-u-values-and-traditional-buildings.pdf> [Accessed 11th August 2015].
- [9] Department for Communities and Local Government. (2009, September). English House Condition Survey ECHS, 2007. [Online]. Available: http://doc.ukdataservice.ac.uk/doc/6449/mrdoc/pdf/6449ehcs_annual_report_2007.pdf [Accessed 11th December 2017].
- [10] Historic England. 2014, May. Energy Efficiency and Historic Buildings: Energy Performance Certificates. [Online]. Available: <https://content.historicengland.org.uk/images-books/publications/eehb-energy-performance-certificates/heag015-eehb-epcs.pdf/> [20th July 2015].
- [11] C. Galdies. (2011). The Climate of Malta: statistics, trends and analysis 1951–2010. [Online]. Available at: https://nso.gov.mt/en/publicatons/Publications_by_Unit/Documents/B3_Environment_Energy_Transport_Agriculture_Statistics/The_Climate_of_Malta.pdf [15th September 2015].
- [12] J. Cassar. "Comparing visual and geochemical classification of limestone types: the Maltese Globigerina Limestone". Proceedings of the 10th International Congress on Deterioration and Conservation of Stone Vol II, Stockholm, 2004, pp. 569–577.

- [13] Building Regulations Office (BRO). Technical Document F Part 1. Floriana, Malta: Ministry for Resources and Rural Affairs, 2015, p. 29.
- [14] V. Buhagiar. "The Refurbishment of Historic Buildings for Re-Use: An Energy Efficient and Heritage Sensitive Approach. Generic Guidelines with Application for Malta". PhD. thesis, Cardiff University, Wales, UK, 1999.
- [15] Building Regulations Office (BRO). Course for Energy Performance of Buildings Non-Dwellings in Malta: Course Notes. Floriana, Malta: Ministry for Resources and Rural Affairs (unpublished), 2012.
- [16] Department for Communities and Local Government. (2015, November). SBEM: A Technical Manual for SBEM. [Online]. Available: http://www.uk-ncm.org.uk/filelibrary/SBEM-Technical-Manual_v5.2.g_20Nov15.pdf [20th February 2016].

Development of a knowledge centre for responsible retrofit of traditional buildings in France

J. Burgholzer¹, E. Héberlé¹, H. Valkhoff², J.P. Costes³ and J. Borderon¹

¹ Centre for studies and expertise on risks, environment, mobility and urban and country planning (Cerema), Strasbourg, France. Email: julien.burgholzer@cerema.fr, elodie.heberle@cerema.fr, julien.borderon@cerema.fr

² Ecole Nationale Supérieure d'Architecture de Toulouse, Laboratoire de Recherche en Architecture (ENSA – LRA), Toulouse, France. Email: hvalkhoff@gmail.com

³ Arts et Metiers ParisTech, Laboratoire Bourguignon des Matériaux et Procédés (LaBoMaP), Cluny, France. Email: jean-philippe.costes@ensam.eu

Abstract – While the French law for energy transition has reinforced the insulation requirements of existing buildings and has set a significant pace for energy retrofitting (500,000 homes per year), it is important to promote a “responsible” rehabilitation approach for traditional buildings, allowing them to preserve their architectural values and to avoid pathologies potentially generated by the insulation works. The “CREBA”¹ project was designed to create a national platform for online resources, aimed primarily at property owners, architects, consulting firms and renovation consultants. The multi-disciplinary team behind this, led by Cerema, is a consortium of engineers, architects and heritage specialists.

Keywords – knowledge centre; resources; case studies; responsible retrofit

1. INTRODUCTION

1.1 TO RECONCILE THE MASSIFICATION OF ENERGY RETROFITS WITH THE PRESERVATION OF HERITAGE VALUES OF BUILDINGS

During 2015, a major law for energy transition was adopted in France. This law set an important political objective: a clear commitment for massive energy retrofits, up to 500,000 homes per year in a 33 million housing stock. Of this stock, about 33 percent are of the “traditional building” type. French law considers all buildings built before 1948, whether rural or urban, as belonging to this type. It covers all constructions made of traditional materials such as stone and wood, which are clearly dissociated from “modern buildings”, built massively from the 1950s, using industrialized techniques and materials.

These traditional buildings that are the focus of the CREBA project, are a particular part of the existing housing stock eligible for retrofit. They are at the crossroads of many environmental, technical and cultural issues since they represent the majority of buildings with heritage value. Their rehabilitation must

1 CREBA in French: Centre de Ressources pour la réhabilitation responsable du Bâti Ancien.

be performed with care, using a “responsible” approach, reconciling energy, technical and architectural concerns.

1.2 CONTEXT IN FRANCE: A NEED FOR IMPROVEMENT IN PRACTICES, DISSEMINATION OF INFORMATION AND TRAINING OF PROFESSIONALS

In France, various surveys have been carried out in recent years to improve understanding of the complex behaviour of traditional buildings, and to propose suitable rehabilitation solutions, using a “responsible” retrofit approach.

As an example, in the east of France, the local representatives of the French Ministry of Cultural Affairs and Ministry of Sustainable Development have developed a guide [1] to promote sustainable rehabilitation of local traditional buildings. The guide in itself can be considered as a starting point to create more sustainable retrofitting scenarios that take into account not only energy efficiency but also comfort, moisture damage and heritage value. The criteria developed in this study have been adapted to other regions and to other challenges. Similarly, various cities and local authorities that are members of the Association “Sites et Cités Remarquables de France” (SCRF), such as Poitiers, Troyes and Grenoble, have developed technical guides [2] that provide solutions for the thermal rehabilitation of various types of old city-centres.

However, too many studies, research programmes and experiments are being relatively overlooked, despite their qualities. All the applicable output provide us with a large knowledge base about the behaviour of traditional buildings and the appropriate retrofit solutions, that needs to be widely disseminated throughout the large building community.

To encourage and develop the professional skills of architects, design offices and craftsmen, and thereby promote a responsible approach to the rehabilitation of traditional buildings, the CREBA project to create a resource centre for responsible retrofit was proposed. It is part of the national “PACTE” programme, an innovation programme supported by the ministry in charge of sustainable development.

This paper aims to explain how the CREBA knowledge centre project was structured and how its different contents were developed.

2. GENESIS OF THE CREBA KNOWLEDGE CENTRE

2.1 GENERAL STRUCTURE OF THE CREBA KNOWLEDGE CENTRE

The aim of the CREBA project, conducted throughout the French mainland territory, is to propose a set of online resources, such as tools, case studies and guides, for property owners, architects, consulting firms and renovation consultants. The ultimate challenge is to enable them to make responsible choices regarding the energy retrofit of traditional buildings and thereby promote the long-term quality of buildings.

The content proposed by the resource centre has several objectives, different recipients, and can be measured by different indicators:

Table 1. CREBA objectives and recipients

Objectives	Recipients	Indicators
To provide centralized and structured technical and scientific resources dealing with rehabilitation of traditional buildings (see section 3)	Architects, consulting firms, renovation professionals (such as craftsmen) and to a lesser extent property owners	Number of online resources Number of resources downloaded
To share examples of good practices via a set of case studies (see section 4)	Architects, consulting firms, renovation professionals (craftsmen, ...) and property owners	Number of case studies posted online Number of case studies downloaded
To develop a decision support tool for responsible rehabilitation of traditional buildings (see section 5)	Architects and consulting firms	Number of operations that have benefited from the tool

2.2 GOVERNANCE OF THE KNOWLEDGE CENTRE

The constitution of such a resource centre requires the cooperation of people from different backgrounds with complementary missions, networks and skills. The founding members of the CREBA resource centre (Cerema, LRA/ENSA Toulouse, Arts & Métiers, Association “Sites et Cités Remarquables de France”, Association “Maisons Paysannes de France”) aim to bring together and develop:

- Different actions: research, support for construction and heritage stakeholders, capitalization of practices, dissemination of knowledge;
- Different networks: researchers, professionals, project managers;
- Different skills: building performance, architecture and preservation of built heritage.

This governance is intended to be extended to other institutional partners, as well as to be rolled out at the level of the French Regions, with the aim of creating local clubs for responsible retrofit.

3. DOCUMENTARY RESOURCE BASE

3.1 KNOWLEDGE REFERENCE SELECTION

It is largely admitted that the rehabilitation of traditional buildings needs a large interdisciplinary knowledge base, from scientific concerns regarding physical behaviour of materials to operational field experiences. As underlined previously, even though knowledge in all the branches of building has been growing for decades [3], efforts to bring this scientific and technical background to professionals have to be boosted. The objective of this platform is to make the technical and scientific knowledge about traditional building rehabilitation available to

professionals such as architects, consulting firms and property owners. The first task prior to creating the resource base is to select a panel of relevant studies dedicated to traditional building rehabilitation. These references in French fall into three main categories: guidance, case studies and research reports. From the 125 references primary identified and read by the CREBA members, over 100 were selected, as specifically addressing the subject. Most of these studies report on historical buildings and experiences in rehabilitation in mainland French territories in either rural or urban settings; some focus on historical city centres such as Paris or Grenoble, on natural parks or areas where a specific and protected heritage building exists, or are general reports applicable to France or European countries.

Many of the selected references can be considered as guidelines since they outline the good practices and the retrofit measures appropriate to specific conditions. The scope of the measures and concerns addressed is broad and can be listed as follows: energy efficiency, insulation materials and fabric of the building, sustainability, air tightness, user comfort, hygrothermal behaviour of walls and others. The topic “Should components or materials be maintained, repaired or replaced?” is often raised and solutions or advice are proposed.

A number of studies depict case studies and present quantitative data such as energy consumption, ambient temperatures and comfort evaluation before and after rehabilitation measures. These feedback data are precious since they may help to decide between several rehabilitation scenarios.

3.2 REFERENCE INDEXATION

For each reference, the objectives and contents, the measures and concerns developed as well as the materials, locations, and specific key words have been summed-up and indexed in a specific form. The level of understanding and the intended public of the reference are also of importance and are therefore also indexed in this form. Indexing each reference as detailed previously will enable the Guidance Wheel (see section 5) to connect a specific concern to one or more studies in the documentation resource base. The web platform will also allow a user to make a request within fields such as locations, concerns, measures and key words to target appropriate references in the knowledge resource base.

4. CASE STUDIES PRESENTING ENERGY REHABILITATION OF TRADITIONAL BUILDINGS

4.1 CONSTITUTION OF A CASE STUDY DATABASE

To share practices, CREBA offers a set of energy rehabilitation of traditional buildings case studies. Projects were selected by the CREBA team through a form [4], which was sent to a large group of heritage or energy professionals (architects, engineers, public institutions, experts) throughout France. The form consists of describing the historic interest of the building and how it was rehabilitated. Over fifty forms were completed within a six-month period.

These fifty buildings were then reviewed in technical partnership committees.

To finally select cases to be examined and to have a range that is as diverse as possible, several criteria were taken into account: location (each of the thirteen French Regions should be represented); type of building (residential and non-residential, listed as a National Heritage site or not); construction materials. Table 2 shows the thirteen selected buildings that are subjected to a case study and Figure 1 shows three of these located in the east of France.

This set of case studies is expected to develop in the coming years.

Table 2. The 13 selected buildings that have undergone a case study

Location	Type of building	Main construction material
Centre-Val de Loire	Multiple dwelling	Stone
Bourgogne-Franche-Comté	Single dwelling	Stone
Grand-Est	Single dwelling	Wood and daub
Grand-Est	Non-residential (Primary school)	Stone
Grand-Est	Single dwelling	Brick
Hauts-de-France	Single dwelling	Wood and daub
Île-de-France	Single dwelling	Stone
Normandie	Multiple dwelling	Brick
Occitanie	Non-residential (University)	Stone
Occitanie	Single dwelling	Mud brick
Occitanie	Non-residential (Media library)	Brick
Pays de la Loire	Single dwelling	Stone
Provence-Alpes-Côte d'Azur	Non-residential (Office building)	Stone



Figure 1. Three of the 13 selected buildings located in the east of France. Photos: CREBA.

Once the buildings were selected, a CREBA member visited each. On this occasion, the project owner or the architect was interviewed. The presentation of each case study contains the same sections: the building and its context; diagnosis of the technical, energy and historic situation; preliminary design of the project; description of the works; summary of the rehabilitation.

4.2 TOWARDS A CHARTER DEFINING RESPONSIBLE REHABILITATION CRITERIA

It appeared that the notion of “good practice” had to be defined very precisely, in order to encourage heritage and energy professionals to apply it in their retrofit projects. A charter was therefore written, approved and shared by all the

members of CREBA. This charter is a reference document explaining the criteria for a so-called “responsible” energy rehabilitation of traditional buildings. It is composed of two main parts:

- General requirements that the operations must respect. The operation must follow a global and contextualized approach, from the diagnostic phase (state and character of the building) to the choice of energy-saving solutions. This global approach is defined by European standard EN 16883 “Conservation of cultural heritage—Guidelines for improving the energy performance of historic buildings” [5];
- Specific recommendations, element by element (walls, windows, floors, etc.), that must be respected for each operation according to their context.

5. DEVELOPMENT OF THE FRENCH VERSION OF THE GUIDANCE WHEEL

5.1 PRESENTATION OF THE ORIGINAL GUIDANCE WHEEL

The Guidance Wheel is an online decision-making tool for retrofitting traditional buildings, developed by the Sustainable Traditional Buildings Alliance (STBA) in the United Kingdom [6]. It aims to give a global approach for responsible energy

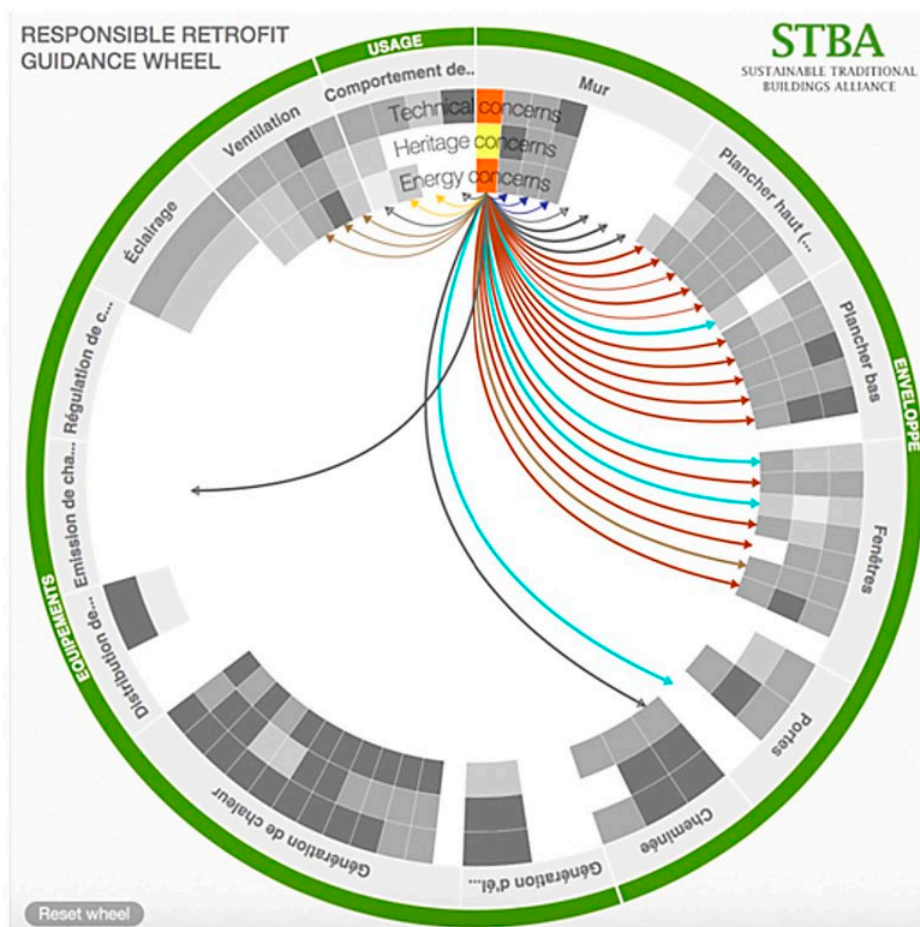

Figure 2. Guidance Wheel for responsible retrofit (STBA).

retrofit strategies by highlighting heritage, technical and energy issues to be considered in the planning process. The tool takes into account user type and building context, e.g. location, exposure, state of repair, etc. This is taken into account via a drop-down menu that is filled in before starting.

The retrofit measures are divided into three categories: building fabric, services and behaviour. For a selected measure, the Guidance Wheel identifies areas of risk to building fabric and occupants, e.g. damp problems, loss of heritage detail, lack of ventilation. At the same time it displays links to other measures that need to be considered in relation to the selected type of building work. The tool also makes it possible to select a series of measures and explore the links between them. For each project and set of measures, the user can explore its technical consequences, as well as energy saving and heritage issues. A side menu is used to explore these in more details, assess the risks and find out about suggested actions to minimise risk. Scrolling down, one finds the references and research which underpin the issues raised and provide further exploration. Examples of best practice help to understand and improve the retrofit building process.

Once the investigation is completed a report with all the advantages and concerns can be downloaded. For further study and the latest updates in the field the user can browse the STBA Knowledge Centre for Responsible Retrofit to which the tool is linked.

5.2 ADAPTING THE TOOL TO THE FRENCH CONTEXT

Exchanges with the STBA started in 2014 when the founding members of CREBA published the HYGROBA [7] study, a risk assessment of retrofit measures for traditional buildings in France based on hygrothermal simulations. One of the authors presented the results of the study at a seminar in London at the time when the STBA launched the Guidance Wheel in the UK. The idea of exporting the tool to France was soon voiced, and in 2016 the STBA provided the CREBA consortium with a 5 year license to develop the French version of the Guidance Wheel. This version will be finished and put online by late 2018, together with the national resource centre for responsible retrofit of traditional buildings.

It was apparent that it was not simply a matter of translating the Guidance Wheel into French, but that the tool had to be adapted to the French building context. With the consent of the STBA, the CREBA partners decided to add certain measures (e.g. thermal improvement) and eliminate others that were considered less relevant to the French context. Similarly, changes were made to the building context to which CREBA added a few more parameters, e.g. building type, which specifically applies to traditional solid walls. These are divided into fired brick, stone (hard and soft), earth walls and timber frame with daub infill. The hygrothermal impact of different insulation techniques and materials for each of these five wall types were assessed in HYGROBA [7]. Other additions to the French building context of the Guidance Wheel are “sources of humidity”, which replaces the original “exposure”. Furthermore, “location” adds three climate

categories commonly used in France (Mediterranean, oceanic and continental). For other context categories, such as heritage and number of exposed sides, minor changes were made in order to adapt them to the French situation.

Despite all the changes to the French version of the Guidance Wheel, CREBA and STBA have managed to keep the integrity and the original interface of the tool. This is also the case for recoding the risk levels for which we followed STBA guidelines, whereby each concern is assigned a risk level expressed by four colours in the Guidance Wheel (Figure 3).

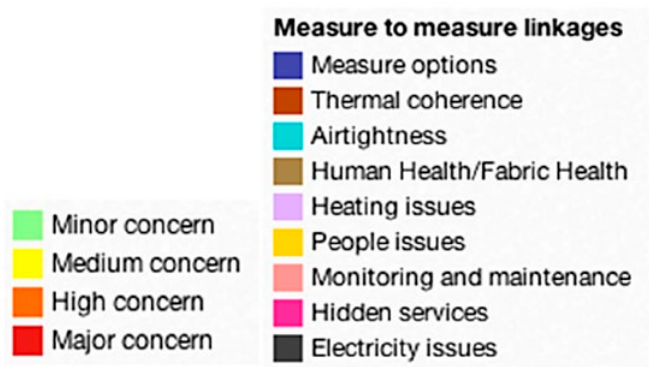

Figure 3. Colour coding of risk levels; colour coding of links between measures.

A technical panel, consisting of CREBA members from Cerema and ENSA Toulouse, re-evaluated the risk levels for each measure and concern, in relation to both the existing and the added context (e.g. wall type, humidity, location).

The panel also reassessed whether measures and concerns are context sensitive, i.e. impacted by a changing building context. In certain cases concerns can be affected by several context categories at the time.

Test runs of the 'new' tool by the STBA programmer ensure that the French version functions properly. In addition, before launching, the French Guidance Wheel will be tested by a panel of building professionals and communication officers without a building technology background. CREBA wants to make sure that a wide audience of property owners, craftsmen, builders, architects, developers and engineers can use the decision-making tool with different interests and levels of energy retrofit knowledge.

6. CONCLUSION

The CREBA resource centre will promote a responsible approach for the energy rehabilitation of traditional buildings and help to increase the skills of building professionals in France. The centre has to be relayed and promoted locally, as close as possible to the people involved in the field. The extension of partnerships is being discussed at this point.

In addition to the initial CREBA resource centre, other services may be proposed in the future, in particular, training, education and the creation of a dedicated label for responsible energy rehabilitation of traditional buildings.

7. ACKNOWLEDGEMENTS

The authors would like to acknowledge Nigel Griffiths, Peter Cook and Isabel Carmona of the STBA for their advice and contribution to the translation and adaptation of the French version of the Guidance Wheel, especially at the more technical stage of risk assessment, recoding and reprogramming.

8. REFERENCES

- [1] Direction Régionale de l'Aménagement, de l'Environnement et du Logement (DREAL), and Direction Régionale des Affaires Culturelles (DRAC) Alsace. "Habitat ancien en Alsace : énergie et patrimoine". Internet : <http://www.grand-est.developpement-durable.gouv.fr/pour-comprendre-et-renover-le-bati-ancien-en-a193.html>, Jan. 27, 2016 [Feb. 04, 2016].
- [2] Association Nationale des Villes et Pays d'Art et d'Histoire (ANVPAH) and Centre d'études techniques de l'Équipement (CETE). "Guide méthodologique pour les villes souhaitant réaliser un audit énergétique de leur centre ancien". Internet: https://www.effinergie.org/web/images/attach/base_doc/1408/guidebat-2.pdf, [2011].
- [3] Martinez-Molina A., Tort-Ausina I., Cho S., Vivancos J.-L. 2016. Energy efficiency and thermal comfort in historic buildings : a review. *Renewable and Sustainable Energy Reviews* (61), 70–85.
- [4] <https://framaforms.org/crebaformulaireoperationsexemplaires-1486636770>
- [5] EN 16883, Conservation of cultural heritage – Guidelines for improving of the energy performance of historic buildings.
- [6] Sustainable Traditional Buildings Alliance. Guidance Wheel. Internet: <http://responsible-retrofit.org/wheel>
- [7] Ministère du Développement Durable, CETE de l'Est, ENSA Toulouse–LRA, INSA Toulouse–LMDC, Maisons Paysannes de France. "HYGROBA : étude de la réhabilitation hygrothermique des parois anciennes". Internet: <http://lra.toulouse.archi.fr/lra/activites/projets/hygroba>, [2013].

Potentialities and criticalities of different retrofit guidelines in their application on different case studies

V. Pracchi and A. Buda

Dept. ABC, Politecnico di Milano, Italy. Email: valeria.pracchi@polimi.it; alessia.buda@polimi.it

Abstract – The paper aims to investigate criticalities and potentialities of the Italian Cultural Heritage Ministry's Guidelines (October 2015) and the European Guidelines for Improving Energy Performance of Historic Buildings (EN 16883 – June 2017), comparing and applying them to selected case studies.

The documents represent an instrument to help public authorities and designers to follow an iterative retrofit process; in both cases it is possible to notice some difficulties in their technical application. Thus, we have identified their critical and positive features through the case studies assessment.

The scope is to underline possible issues and to suggest new solutions in both cases, improving the existing guidelines with other targets to obtain a calibrated evaluation method, which could guide the retrofit project.

Keywords – historic buildings retrofit; Italian Cultural Heritage Retrofit Guidelines; EN 16883 Guidelines

1. INTRODUCTION

The reason to analyze the European Guidelines EN 16883 [1] and the Italian 'Guidelines for the improvement of energy efficiency in cultural heritage' [2] is to check how they address the design process, defining suitable interventions for the retrofitting of historic buildings.

Heritage buildings need special protection actions; hence improvements must be carefully weighed to balance conservation needs and increase performance [3]. The two documents mentioned above are not mandatory, but they are worth knowing and analyzing. The goal is to help the stakeholders involved in the process (whether designers or heritage authorities) in a well-thought assessment of possible solutions, before their implementation.

The purpose of this paper is to check these documents, through their application to different case studies, to explore potentialities and limits and, if possible, to suggest improvements.

1.1 EUROPEAN AND ITALIAN GUIDELINES

The two guidelines are certainly different, although they have the same purpose. The European standard is synthetic and aims to guide the lecturer in the proposed procedure; the Italian one is very long and structured as a book.

In EN 16883, despite its brevity, important concepts are highlighted. Among them, a few main concepts are the importance to pay attention not only to exceptional buildings, but also to ancient city centers, focusing on authenticity – integrity – significance of the building, considered as an entirety. It is also specified that “Maintenance is the best conservation measure” and that in this field also “non-standard measures could be considered”.

In contrast, the Italian guidelines are a collection of restoration theory concepts (as the important distinction between improvement and adaptation, borrowed from the Italian Guidelines for the seismic vulnerability assessment of historic buildings) and technical parts to support people in performing energy diagnosis.

The text is divided in three sections: knowledge of contexts (including environmental quality assessment for historic buildings); energy efficiency assessment (in this part the retrofit procedure flowchart is exposed) and energy efficiency improvement (which includes a description of possible retrofit interventions, a paragraph about maintenance costs and a collection of best practices).

The last section is followed by supplementary technical sheets (some of which dedicated to photovoltaic insertion). This part of the volume also refers to non-standard solutions (e.g. fixing a second window in contact with the first instead of modifying the existing one), underlining that choices should be made considering the preservation of the heritage values. Other retrofit measures linked to the exploitation of the environment are also quoted (e.g. the use of trees and water in dry climate for comfort purposes). The goal of these sheets is to ‘wisely’ consider a range of possible measures, focusing on innovative materials and explaining pros and cons of each retrofit technique. However, we will see that one of the main shortcomings is an imperfect integration between theoretical and technical parts.

1.2 CASE STUDIES

To compare the two guidelines and understand their potential, we applied them on three case studies, different for climatic conditions, installations and use. The first two cases (Verga’s House and Pepoli Museum) are situated in Sicily. The third one (Rebecca house) is situated in the historic centre of a mountain village in Lombardy. All of them are protected with different legal constraints (see Table 1).



2. APPLICATION OF EN 16883 GUIDELINES ON CASE STUDIES

2.1 STEP 1: BUILDING SURVEY AND ASSESSMENT (CHAPTER 7)

The procedure consists of six steps and must be carried out by a multidisciplinary team. The first step is structured in nine points as a collection of information about the building, useful to address the next stage of the planning process.

The first three points collect general data (historical, constructive, legal); the fourth point asks to highlight opportunities to reinstate lost or hidden character-defining elements (e.g. restoring the original window / replace an identical one), conservation priorities or constraints on behalf of the local heritage authorities,

Table 1. Case studies

Case Studies	(1) -Verga's House	(2) -Pepoli Museum	(3) -Rebecca House
			
<i>Building information</i>	Listed house-museum in a three-level palace 350 m ²	Listed museum and library with courtyard on two levels 1350 m ²	Old abandoned farmstead on two levels 90 m ²
	18 th century 1980 restoration works	14 th century 2013 restoration works	18 th century neglected
<i>Location and Climate zone</i>	Catania (Sicily) city centre	Trapani (Sicily) outskirts	Lavone (Lombardy) mountain
	B – 833 HDD	B – 810 HDD	F– 3227 HDD
<i>Building description and condition survey</i>	Lava stone masonry walls; paper wall inside	Sandstone walls with plaster finishing	Stone walls with plaster finishing inside
	vaults cover the pitched wood roof	vaults cover the insulated pitched wood roof	broken pitched roof with tiles and wood structure
	wooden window frames with single glass	wooden window frames with single glass and shutters	wooden window frames with single glass; chimney
	19 th century furniture; moisture problems	new exposition area in glass; good condition	no pavement; air leakage; moisture problems
<i>Plant and lighting system</i>	Split systems; halogen lamps	Split systems+ HVAC&R; halogen lamps	No plants; no lamps.
<i>Energy performance</i>	By audit and bills data	By audit and bills data	Static and dynamic simulation
	167.73 kWh/m ²	152.49 kWh/m ²	540.00 / 275.90 kWh/m ²

to understand the limitations of the intervention to define where, how much and how to intervene. There is a risk that there will be too much focus on the single building node rather than on a set of calibrated actions, which should constitute the purpose of the procedure.

In the following two points (5-6) it is required to define the intended use and to map the building's condition. In our opinion, it would be more effective to reorganize the order of points 4-5-6, proceeding first with the 'Mapping building's condition and environmental influences' (point 6), then with the definition of the 'Intended Future Use' (point 5) and finally with the definition of opportunities, meant as improvement actions, well-balanced both on conditions and needs of the building (point 4). Accordingly, we have defined opportunities as improvement suggestions for each case study:

- Case (1): interventions could be limited to roof and fixtures, due to ancient finishing. Microclimate control might be provided to preserve existing collections;
- Case (2): it might be considered to add trees in the courtyard creating shade for the new glazed-in exhibition area during the summer season, as well as adding curtains or solar control window films, to avoid thermal shock damage for collections;

- Case (3): it might be possible to improve and restore loft hatch and ground-level to mitigate internal conditions and limit infiltrations.

Point 7 requires the energy performance assessment, that could be done by an energy walk-through audit, by an analysis of energy use and consumptions (asset rating) [4] or by calculating the energy performance in-depth (tailored rating) [5]. It's important to underline the guidelines' remark on calculation methods' difference: for historic buildings, a tailored method is recommended because it allows evaluating non-standard conditions with case-by-case variable input data, whilst a standard calculation method is more limiting due to its simplifications. In our opinion, this part should be highlighted to alert against interventions based on reductive approaches. Our case studies are examples of application of these different methods: the performance of cases 1 and 2 has been assessed by the Energy Authority of the Sicilian Region, analyzing their energy bills (asset rating). The real consumptions were compared with calculation data, extracting by using a static simulation software (MC4) in standard conditions: results led to a difference of 8–10 percent in favour of the measured data. This difference is attributable to the simplification of the static software, not suitable for the evaluation of the thermo-physical behaviour of historical buildings. With a static calculation method, although results are quickly produced, there are numerous issues, such as lack of adequate databases and inability to define more complex parameters (infiltration rate, internal gains and weather data) [6].

Energy performance of case 3 has been evaluated both with a static simulation software (CENED+, freely provided by Lombardy region) and a dynamic one (EnergyPlus) to compare the two methods results. This case study has a singularity: it has no HVAC system which can be a common condition in historic buildings. The CENED+ software cannot run in free-floating conditions: it is structured for energy audit and labelling of modern constructions, this means that it considered a false implant as default. Furthermore, input data were entered from the general database, which is not properly targeted for historic buildings. Hence, an approximate result was obtained quickly, in terms of global primary energy (540 kWh/m²). In contrast, the dynamic evaluation tool has allowed modelling each input parameter: 1 detailed data were included both for describing climatic conditions, geometry and building properties. As output, building energy requirement could be verified (275.90 kWh/m² – equivalent to half of those simulated with the standard method). It has also been possible to evaluate other parameters, useful for a complete evaluation of performance needs, such as infiltration losses, relative humidity, surface temperature, solar gain and daylight luminance to verify comfort needs. Although dynamic simulation involves more time compared to the static one, it gives more accurate data.

According to our findings, a correct energy performance assessment is important to make decisions in the following phases on retrofit options. The limit of both

1 Four thermal zones have been identified (room 1, room 2, loft hatch and ground level), imposing for the two rooms +20 °C for heating period and +26 °C for cooling period with an infiltration rate of 4 changes/hour, due to the high air leakage. Climate data: Collio meteo station (Brescia).

methods is found in the correctness and accuracy of the input data that must be calibrated on measured data [7]. However, the output data must also be evaluated properly, according to the building needs and use. The guidelines are not necessarily directed towards one or the other method; however, one must be more explicit about their pros and cons.

2.2 STEP 2-3: OBJECTIVES AND END OF PROCESS (IF NEEDED) (CHAPTERS 8-9)

The second phase of the procedure requires defining objectives and targets according to the priority criteria that address the project in the planning phase. Before this step, it is mandatory to define some criteria, upon which future action lines should be based. Objectives are specific and refer to individual cases and are therefore variable, whilst some guiding criteria could be of general validity, referring to the need of protection. In Figure 1 we propose possible criteria, subdivided into different fields (Heritage, Efficiency and Users), to which single objectives are referred for each case [8].

At this point, after the second step, it is possible to interrupt the process, although no scenario has been proposed or verified too. In our opinion, this possibility should be postponed in the downstream of the flow chart. Prior to excluding measures, it will be necessary to evaluate their effectiveness to decide whether to apply them or not. Hence, even in the most critical cases where it is not possible to work on the building envelope, it is still possible to improve energy efficiency, with high-performing energy production systems and appropriate management technologies [9].

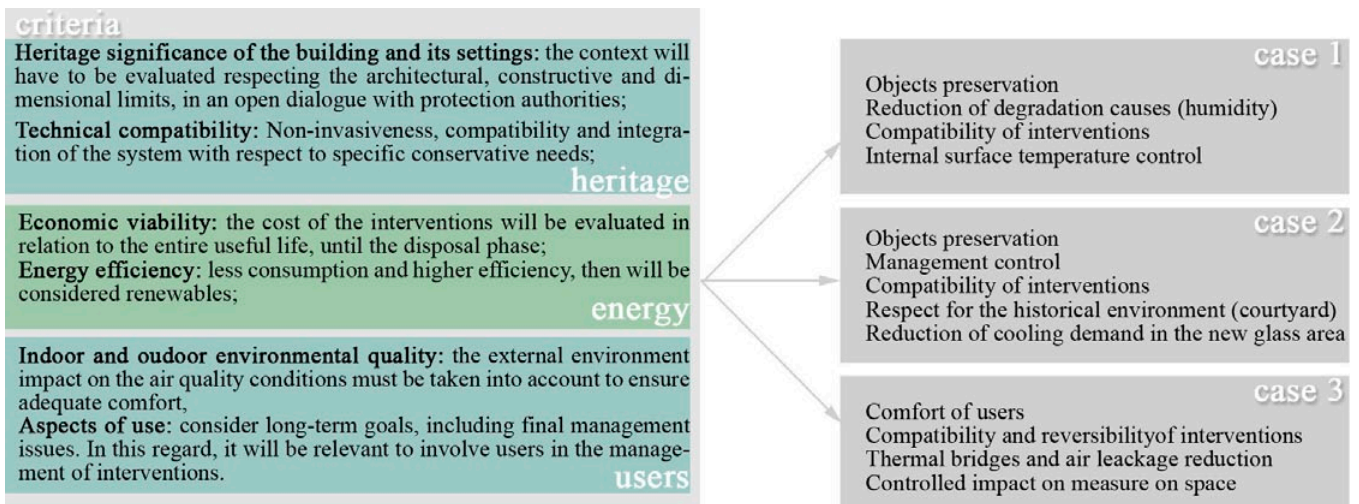

Figure 1. Criteria and objectives

2.3 STEP 4: SELECTION OF MEASURES AND ASSESSMENT OF PACKAGES (CHAPTER 10)

The fourth step provides for the definition of retrofit measures. Starting from a list of common ones for the three cases, they have been divided into three categories: interventions on the building (e.g. wall insulation, window refurbishment, etc.), interventions on the HVAC system and user involvement and building management. For each case, the most appropriate options were selected

from those listed (e.g. in case 1, given the presence of antique finishing, work on floors and walls were excluded, but interventions such as system replacements, building automation control, curtains, etc. could be considered). In the guidelines, it is expected that retrofit actions are individually evaluated and grouped together afterwards. However, assessing them singularly does not make it possible to evaluate linked effects given by the whole system, further extending the verification times. At this stage, it is therefore preferred to combine them in packages (e.g. in the case 3: package 1='refurbishment' includes removal operations of degradation and roof improvement, to limit the problems of water infiltration presence).

For the evaluation of the selected packages, a risk-benefit analysis is proposed. The assessment can be made on a five-level scale through the examination of qualitative data (risk of material and spatial impact, influence on the use, etc.) and quantitative ones (energy performance, comfort data, payback time, GHG emissions, etc.). Some critical aspects of the method – highlighted from the comparison among the three cases – are shown below:

- We assessed the same group of measures in two climatic contexts, to check if specific problems related to different conditions were highlighted by the procedure. The combined interventions 'thermal-insulating plaster + windows substitution' were tested, both in climate zone B, case 2, and climate zone F, case 3. In both risk evaluations, the result does not change, although there are clear differences. According to that, it was considered to add a set of categories to underline specific issues: 'overheating', and 'insufficient ventilation' for the case study number 2, 'interstitial condensation' for the number 3. This means that to correctly assess the effects of interventions, perhaps it would

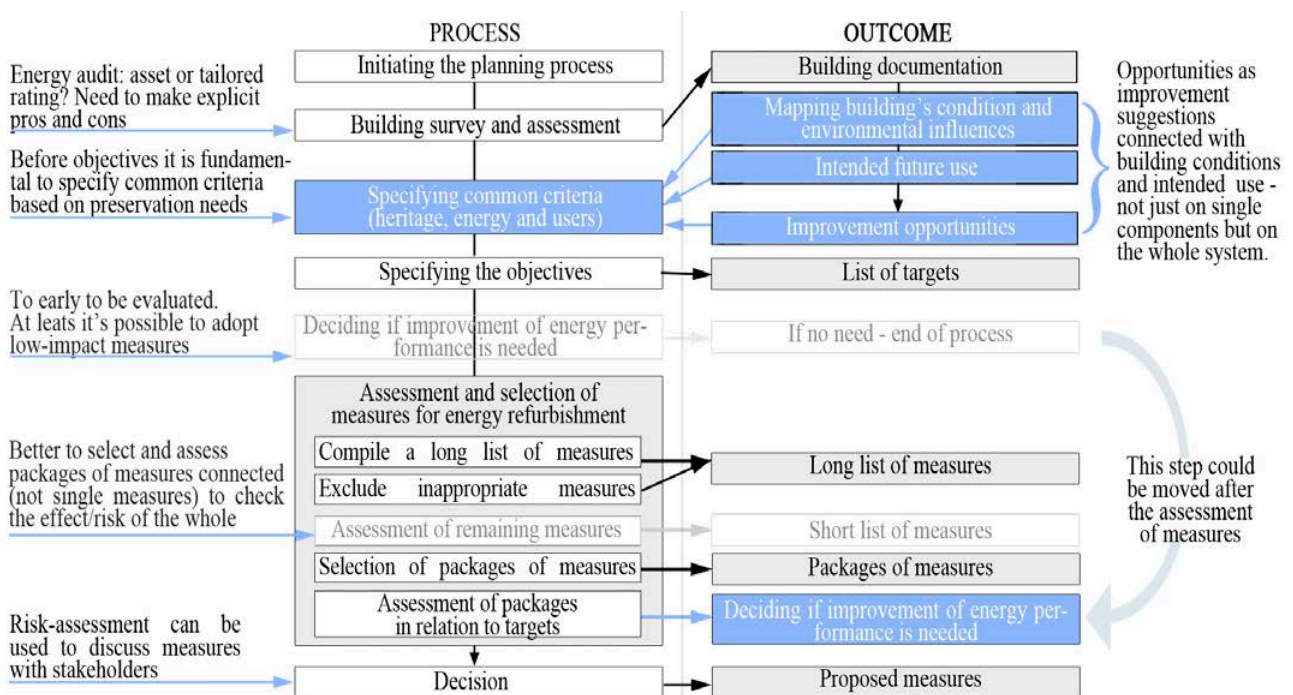

Figure 2. European Guidelines flowchart showing the proposed procedure with comments.

- be necessary to define specific risk parameters, considering for example climate zone or future use of the building;
- The measures have to be designed in relation to the objectives previously set out. For example, in assessing the introduction of a ventilation system in case 1 and 2, having to preserve the art collections, the jeopardy of deterioration of the objects should be verified before.

After evaluating the packages of measures for the three examples, it was not possible to have a clear vision of the results at the end of the process. As the guidelines mention: “This method should not be seen as a mechanical tool that provides an answer” (chapter 10.2), but it’s meant to allow a transparent dialogue to make a decision on intervention. Thus, the assessment procedure represents a possible basis of work to discuss different proposals with the team and all the stakeholders, according to criteria and objectives, established case-by-case [10].

3. APPLICATION OF ITALIAN GUIDELINES ON CASE STUDIES

The guidelines’ proposed procedure provides a waterfall model with five steps. The first step is the collection of building data (geometrical, architectonic, structural, etc.) as in the European guidelines. This part will be functional to the energy assessment, which will take into account local legislation and standards [11]. Who will be in charge to do the energy performance analysis will define its level of detail (standard, asset or tailored analysis according to the Italian standards UNI TS 11300:2014); the decision will depend on the availability of resources and time, causing different output data quality. At the end of this step, the final goal is to reach the evaluation of the Primary Energy (EP) of the building. Later, possible measures have to be selected. Once possible interventions are established, the performance of EP after implementation will be evaluated for each of them. The value of primary energy before and after each measure should therefore be compared. If the intervention has led to a reduction of primary energy ($EP' < EP$), it will be possible to proceed with its realization, otherwise it is mandatory to restart the procedure, redesigning the retrofit measures [12].

As is evident, the application of this procedure on the three case studies, has led to a comparison of performance data, before and after, without providing elements in terms of compatibility of the historic building. Looking at the case 1, for example, a substitution of existing windows (historic wooden frame with single glass to PVC window frame with double low-e glass) would result in a reduction of primary energy, but would have impact on the whole system, such as an overheating risk in the rooms (with a 100 % discomfort index), a visual impact risk, as well as the irreversibility of the intervention. So, in the suggested process, retrofit projects seem only limited to a building parts replacement [13]. A data analysis phase and a selection of criteria for guiding the interventions are missing, differently from the European equivalent.

Scrolling through the pages of the Italian document, however, there are numerous ideas for a careful evaluation of the interventions (e.g. from the environmental quality assessment to comfort parameters, from glare criteria to the suggestion of non-standard measures to intervene in museums). We notice that the process

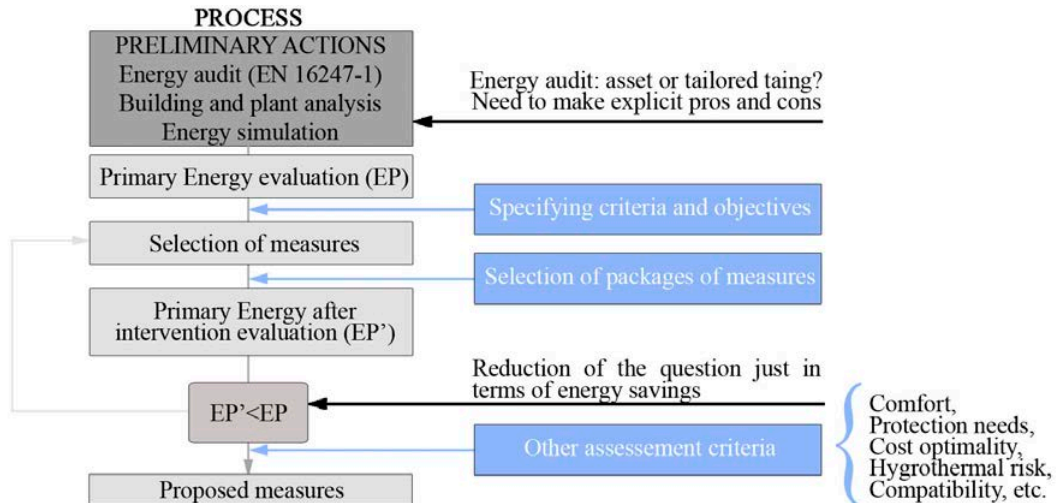

Figure 3. Mibact Guidelines flowchart showing the proposed procedure with comments.

needs to be enriched in a more organic way, integrating those criteria that are expressed in the other part of the guidelines, focusing more on the needs of historic buildings.

4. CONCLUSIONS

In both guidelines, the first part is dedicated to the building survey and data collection, meant as the lecture and evaluation of possibilities and constraints for a retrofit action (identifying where and how to intervene). However, the building should also be examined considering its thermo-physical behavior for taking advantage of the acquired knowledge during the further elaboration of the project [14]. This could be done studying in detail materials, structure and degradation forms and causes (often related to the presence of water).

The analysis of the energy performance assessment that we have done, highlighted issues due to the different methods choice. In the future, the research should focus not only on the already mentioned lack of data about historic buildings, but also on simulation tools and on the importance of estimating benefits and drawbacks, associated with the introduction of new devices.

Before starting with next steps of the retrofit decision-making, it would be necessary to introduce a list of previously defined criteria and objectives, which we aim to achieve in the assessment of retrofit measures. The difference among criteria and objectives is that criteria are valid as guiding principles to address the retrofit project, whilst objectives are differently defined for each case study. The set of them would be useful to check the congruence of all retrofit measures according to the preservation needs [15]. Alternatively, this check of congruence could be postponed to the last phase of the risk assessment, which is the most important to be examined. Absent in the Italian document, this one plays a central role in the European guidelines, where in our opinion, it should deserve some

calibration. In fact, if the assessment is compiled by a multidisciplinary team, it would be as a multicriteria evaluation, in which each actor considers the single choice according to his point of view. Hence, for example, a window replacement could be positive if considered from an energy expert's point of view, but negative for an expert in heritage protection.

A way to compare all stakeholders' requirements could be to adopt a multicriteria chart model, which allows to consider the historic building's conservation needs and to easily organize the assessment of different options. Each criterion shall have a score, from 1 to 5 (as in the European case), which can be modified with multiplication coefficients. Weights could result from a comparison among the criteria, determining which ones are the most often successful and then assigning them proportional multipliers. The aim has to be not to define just a classification, but to bring out the issues to evaluate in a multidisciplinary context. In the Italian document, an attempt to weigh the criteria is found in the attached technical sheets, in which some examples of interventions are evaluated according to the categories of invasiveness, reversibility and compatibility. However, it's possible to notice different ways to interpret the same kind of interventions (e.g. the substitution of an existing roof with a new one is considered reversible in one case study and not reversible in another one).

One more important issue is that the building impact assessment should consider no single measures, but the whole, considering their effects on the microclimatic change. To avoid the most frequent mistakes, some recommendations could be added in the process before proceeding with the intervention, promoting awareness of possible repercussions on the building:

- Do not exceed the intervention, pursuing the logic of adjustment (i.e. compliance with standards requirement, suitable for modern construction), by renouncing interventions that, in absolute terms, may upgrade more, but have excessive impact [16]. Hence, the aim of an improvement action is not "doing everything", but "doing only what you need, where you need it", moving from the idea of 'Best Available Technology' to 'Best Allowed Technology';
- Take into account the building thermal properties: historic buildings have a different behaviour compared to those of new constructions. Their thermal capability guarantees fair performance, especially in hot climates. It is counterproductive to "seal" these buildings because of their need to "breathe" [17];
- Strengthen the existing building resources before promoting new interventions (e.g. restoring natural ventilation, enhance walls mass, etc.);
- Do not propose interventions not suited for the climatic context. Italy is constantly facing the negative effects of interventions, done to achieve a better performance without paying attention to the climate (e.g. massive adoption of insulation as retrofit intervention both in the north and in the south of the country);
- Consider the different climate needs choosing the most suitable measures. In temperate climate, appropriate materials should be chosen to mitigate the effects of both summer and winter demands, avoiding the adoption of materials with low phase displacement and attenuation. In hot climate, suitable

- measures should be adopted to reduce cooling demand mostly in summer period like a shade system;
- Take into account users' comfort needs [18]. This is one of the weak points of both documents. First of all, it is necessary that interventions should be carefully evaluated on the basis of comfort parameters (hygro-thermal, visual, acoustic), to avoid repairs in the future (e.g. if the building is overly sealed, probably it would be necessary to add air conditioning and forced ventilation, leading also to a cost increase, as well as an environmental damage, that will reduce the advantages);
 - Avoid considering savings as a simple saving of money or energy (sustainability does not mean spending less). Improving the performance also means avoiding degradation, not losing important and delicate parts (such as paintings, frescoes, wooden works, etc.), postponing restoration works. A cost-benefit analysis should be considered in a broad sense, including the entire useful life cycle of components or interventions.

5. REFERENCES

- [1] EN 16883 "Conservation of cultural heritage – Guidelines for improving the energy performance of historic buildings", June 2017.
- [2] MIBACT, "Guidelines for the improvement of energy efficiency in cultural heritage". October 2015.
- [3] Italian Ministry of Cultural Heritage. "Legislative Decree no.42 of 2004 – Code of Cultural Heritage".
- [4] EN 16247-2:2014 "Energy audits – Part 2: Buildings".
- [5] EN 15603: 2008 "Energy performance of buildings – Overall energy use and definition of energy ratings".
- [6] Adhikari R.S. *et al.* "Energy Behaviour in Historical Buildings: Limits and Potentials for the Project Evaluation" in Conference Proceedings Plea 27th, Louvain-la-Neuve 2011, pp. 515–520.
- [7] Adhikari R.S. and Lucchi E. and Pracchi V. "Experimental Measurements on Thermal Transmittance of the opaque vertical walls in the historical buildings" in Conference Proceedings Plea 28th, Lima 2012.
- [8] STBA. "Planning Responsible Retrofit. Retrofit Wheel" <http://responsible-retrofit.org/wheel>. 2015 [2016].
- [9] De Santoli L. (2015, January). "Guidelines on energy efficiency of cultural heritage" in Energy and Buildings. [On-line], 86(534–540). [October 10, 2017].
- [10] 3nCult Project. "Energy efficiency solutions for historic buildings. Planning of interventions", pp. 82–117.
- [11] Legislative Decree 4th June 2013, n.63.
- [12] AiCARR Guidelines "Energy Efficiency in Historic Buildings", 2014.
- [13] Pracchi V. "Efficienza energetica e patrimonio culturale: un contributo alla discussione alla luce delle nuove linee di indirizzo" in Atti del Convegno Scienza e beni culturali, XXXII, Brixen 2016, pp. 717-726.
- [14] Franco G., Magrini A., Historical Buildings and Energy, Elsevier, 2017, pp. 4–5.
- [15] Tor Broström *et al.* (2015, March). "A transdisciplinary approach on the energy efficient retrofitting of a historic building in the Aegean Region of Turkey"

- in Energy and Buildings. [On-line], 96(128). Available: www.sciencedirect.com/science/article/pii/S0378778815002108 [October 24, 2017].
- [16] Mazzarella L. (2014, November). “Energy retrofit of historic and existing buildings. The legislative and regulatory point of view” in Energy and Buildings. [On-line], 95(23–31). [May 2, 2017].
- [17] Entrada Silva H. *et al.* “Preventive conservation of historic buildings in temperate climates. The importance of a risk-based analysis on the decision-making process” in Energy and Buildings, 107(26–36).
- [18] Gasparella A. *et al.* (2015, May). “Multi-objectives optimization of Energy Efficiency Measures in existing buildings” in Energy and Buildings. [On-line], 95(57–69). [September 11, 2017].

Technical guidelines for energy efficiency interventions in buildings constructed before 1955 in Greece

**E. Alexandrou¹, M. Katsaros¹, D. Aravantinos², K. Axarli²,
A. Chatzidimitriou², A. Gotoudis², Th. Theodosiou² and K. Tsikaloudaki²**

¹ School of Architecture, National Technical University of Athens, (NTUA), Athens, Greece.
Email: eealexandrou@gmail.com

² School of Architecture, Aristotle University of Thessaloniki, Thessaloniki, Greece.

Abstract – The Greek EPB regulation was recently reformed. During this procedure a scientific workgroup produced a series of Technical Guidelines for energy efficiency interventions in the existing building fabric constructed before 1955 (year of the 1st building code), in order to be implemented in the new legislation. These old buildings differ in architectural form and demonstrate diverse structural characteristics, construction materials and thermal properties. The main goal of the working group was to classify this building stock, in order to address a series of appropriate energy efficiency intervention guidelines, targeted to the specific characteristics of the buildings in each category. The guidelines focus on a sustainable restoration approach with minimal and selective low impact interventions that can be applied either during a large scale renovation project or in repairing specific building components, even in officially protected buildings without being necessarily compelled to comply with the minimum EPB requirements.

Keywords – energy efficiency; heritage value; building regulations; EPBD; preservation

1. INTRODUCTION

The building sector is among the most energy intensive and responsible for a substantial amount of CO² emissions. Moreover, it poses a significant impact on the environment, throughout its life cycle (construction, use and end of life) as a large amount of materials and nonrenewable resources is consumed. Sustainable environmental construction and use of buildings has become a necessity. The European directive on the energy performance of buildings 2010/31/EU (EPBD) was developed in order to set the requirements on the improvement of the energy efficiency of buildings. However, the regulations have been applied mainly in new constructions and much less on the existing building fabric. In addition, the EPBD does not meet the specificities of older buildings of traditional architecture [1] with significant potential for enhancing its energy efficiency, as EPBD's requirements and procedures cannot ensure or preserve their architectural value, and in practice, these buildings are either excluded from upgrading its energy performance -as 'listed building'- or enforced to change their original architectural features. 'Listed buildings' comprise only a small percentage of the old building

stock. A large number among them, possess heritage value (historic, cultural, architectural) but are not protected by any preservation regulation. In Europe, 23 percent of the existing fabric was built before 1945 [2]. Preserving, upgrading and reusing this valuable building stock instead of replacing it, is a sustainable approach, as it saves energy and resources, while at the same time preserves the history of the built environment and sense of a place.

In Greece, the first regulation on the energy performance of buildings was adopted in 2010 and was reformed in 2017. As in other European countries, the old directive excluded listed buildings and protected monuments from energy efficient retrofitting. This was mainly done due to the fear that such interventions may distort or damage significant building characteristics and challenge their historic value. This is a realistic possibility, as knowledge and expertise on cultural heritage, thermal comfort and energy efficiency is constantly advancing. On the other hand, the numerous traditional and historic buildings that are not listed or protected may retain some cultural value that will be discounted upon restoration and energy improvement works. The paper discusses the work elaborated by the scientific group, that produced a series of Technical Guidelines on 'energy efficiency interventions' to traditional or historic buildings, that was implemented in the recast of the Greek regulation, focusing a) on the classification of the 'existing building stock' and b) to outline specific technical interventions corresponding to each category.

2. THE EXISTING BUILDING STOCK AND ENERGY REGULATION

2.1 EXISTING BUILDING STOCK

The existing building fabric in Greece, and especially the buildings built before 1955 (the year of entry into force of the 1st Greek Building Code), is characterized by great diversity. Buildings representing the country's turbulent history are scattered in cities, suburban areas, settlements and in the countryside. They retain architectural and structural characteristics owed to local traditions along with foreign influences, especially those of the many cultures that occupied



Figure 1. Examples of the Neoclassical, Eclectic and Interwar era. Photos: Eleni Alexandrou.



Figure 2a, 2b, 2c. Traditional buildings within and outside settlement's boundaries. Photos: Eleni Alexandrou.

the country and left remnants of their architecture and construction technology (Romans, Venetians, Ottomans, Western Europeans, etc.), Figure 1. As a result, Greece in its small geographic area, demonstrates a relatively rich structural and architectural fabric that needs to be identified, preserved for its historic value, and thus addressed accordingly prior to any 'restoration and energy improvement project'.

A substantial number of the discussed urban fabric consists of the so-called 'traditional' buildings, due to the materials and construction methods used. These buildings may differ in architecture and articulation, but they are all constructed with stone, wood, mud and lime, all local natural materials that demonstrate particular physical, thermal and structural qualities. The majority of traditional buildings are located in traditional settlements or historic districts, most of which are officially protected (Figures 2a, 2b), but many others of the same typology and construction are found outside the settlement's boundaries or in remote areas and thus do not fall under similar restrictions (Figure 2c). Finally, a group of the pre-1955 building stock comprises representatives of local architectural traditions, (vernacular, neoclassical, pre-industrial and of the interwar era) with remarkable elements that may interfere with energy retrofitting works.

2.2 DEVELOPMENT PROCESS AND METHODOLOGY

The purpose of the technical guidelines was to resolve issues on energy efficiency upgrades of buildings constructed before 1955 currently in use, or in the process of small or large-scale renovation, in order to be reused. The first step was to clarify the building typologies and the level of protection on each one of them, to find the most accurate classification, and address a series of appropriate energy efficiency intervention guidelines, targeted to the specific characteristics of the proposed building types in each category, aiming in preserving the character-defining elements of the building.

Buildings that are listed either as monuments, or as part of a designated environment (traditional settlements or historic districts), comprise of a variety of constructions, built under different historic and socioeconomic circumstances. As such they are hard to classify in order to dictate appropriate common solutions.

Even though they are excluded from the minimum energy performance requirements, they could be energy upgraded, even partially, with pointed low impact reversible interventions, under specific circumstances, regulation and audit, without compromising their inherent qualities and heritage value.

Traditional buildings though, and especially the ones found within settlements, are easier to classify, as they possess common building typologies, construction materials and techniques as well as particular architectural, structural and thermal characteristics. Their response to climatic conditions is very different from the contemporary building systems and thus cannot be treated with similar techniques for energy efficient interventions. Their adaptation to contemporary energy requirements is a very complex issue that needs to be addressed accordingly in order to preserve their thermal and structural qualities. The regulatory parameters that need to be examined in their case are orientation, climate, thermal and moisture properties, building geometry and use.

Buildings that are not officially protected by heritage legislation have no restrictions and should comply with EPB regulations when restored. Nevertheless, they contain the majority of the examined building stock and in most cases demonstrate differentiated structural and thermal properties compared to the ones constructed after 1955. Furthermore, a significant number of them may retain heritage significance, as they consist of particular examples of local architectural and construction traditions of the country and in many cases represent their period of construction. At present, there is a danger that restoration and energy improvements undertaken on such structures will take place under insufficient guidance of experts and probably no concern or knowledge on their character and intrinsic qualities, usually following the predominant construction techniques of a specific place. All of the above may result in misjudgments that may not improve the energy efficiency of a building, and may distort the structural and thermal balance or cause disfiguration, irreversible damage and even depreciation. Hence, there is a need for official guiding and training on such practices, in order to define upgrades compatible to the characteristics of such buildings that will preserve their qualities and value, and make them responsive to contemporary needs and requirements. Nevertheless, as the aforementioned stock consists of structures that differ in architecture and structural characteristics, there cannot be a common methodology for energy and thermal improvement interventions.

2.3 BUILDING CLASSIFICATION

The analysis and assessment of the pre-1955 building stock, as described above, concluded in five distinct categories in which buildings would be classified, based on their heritage value and construction characteristics. For every restoration and energy improvement project to be initiated, the building that is subject to energy improvements will be classified by the auditing agent (Designated local Architectural board or the Ministry of Culture), to one of the five categories indicated in Table 1, in order to determine the level of protection and allowed interventions. Before this step, a detailed survey should be completed based on

a recording log, in order to record and assess the existing condition prior to any intervention. The information needed is related to climatic zone, geometry of the natural and built environment around the building, use, architecture, historic and cultural value, level of protection (if any), detailed description of the building and its components (geometry, number of floors, orientation, construction history,

Table 1. Classification of buildings investigated

Code	Building categories
K1	Listed as Monuments
K2	Listed Buildings
K3	Buildings in listed Traditional Settlements
K4	Buildings constructed before 1955 w/ particular Architectural value
K5	Buildings constructed before 1955 w/ no particular Architectural value

building materials and bearing system), and finally an assessment of the existing thermal and energy performance.

- K1

Buildings in this category are listed as 'Monuments' and are officially protected according to Greek Legislation 3028/02 and thus excluded from the requisite/obligation to comply with the minimum EPBD requirements during renovation. (GR L. 4122/13) [3].

- K2

Buildings in this category are listed either by law provisions (GR L.4067/12), [4] or by the Ministry of Culture and are also excluded from the requisite/obligation to comply with the minimum EPB requirements during renovation (GR L. 4122/13). However, the technical guideline suggests, that particular low impact sustainable interventions could be applied in order to improve energy and thermal performance during restoration or renovation process. The interventions should in each case retain the special architectural, structural and thermal characteristics, and preserve its value.

- K3

Buildings in this category are within the limits of Traditional Settlements, which are officially protected and thus also excluded from minimum EPB requirements. As in K2, low impact energy interventions are suggested. Special attention should be given to newly constructed (after 1955) buildings that retain, as directed by the law, the architectural characteristics originally found in the settlement but are constructed with contemporary means, and therefore need to fully comply with energy performance directives during construction or renovation.

- K4

Buildings classified in this category may possess remarkable characteristics (architectural or structural) but are not listed as of in K1, K2 and K3, even though they represent local architectural traditions of Greece and thus may retain architectural, cultural and historic value. Before the initiation of any work, a 'detailed

record file' should be complied to the submittals required by the building code for a pre-building permit for cases of contemporary interventions or renovations in buildings prior to 1955. Subsequently, the building may be classified in category K2 or K3. If it does not suit in any of these, but the board concludes on its architectural or cultural value as a representative example of a specific time in the building history of the country, the guidelines suggest specific interventions.

- K5

Buildings in this category have no significant architectural, cultural or historic value. As such, before any major renovation or energy improvement intervention, a detailed file should be submitted at the local Architectural Board for auditing and authorization. Minimum EPB requirements should be met.

3. TECHNICAL GUIDELINES

The technical guidelines present a toolkit of technical instructions for implementing construction works on the structural elements and the technical systems of a building, during the process of energy efficiency upgrade. The instructions are basically focused on a) improvement of the thermal performance of a building

Table 2. Sample of the concise table on encoded interventions

Building evaluation/audit		Building categories				
		K1	K2	K3	K4	K5
Building characteristics/ possible interventions						
Cultural & architectural value						
Load bearing capacity						
Soil condition						
Technical papers						
Energy performance						
Structural components/ thermal improvements		Energy efficiency obligation by each category				
		K1	K2	K3	K4	K5
Exterior walls	Stone masonry					
	Brick masonry					
	Timber framed					
Roofs						
Floors						
Interior walls						
Openings						
Shading systems						
Mechanical systems						
Passive systems						
Renewables						

component, or the whole building, b) integration of technical systems (EMP) or renewables, and c) environmental upgrade of the open spaces around the building.

A presentation of the construction systems and materials of each building component, such as wall types (stone or brick masonry, timber frame), roofs (flat or sloped), floors, internal walls or partitions and openings, regarding their thermal properties and their energy performance characteristics, is followed by a detailed description and pre-calculation of possible alternate interventions, targeted to the characteristics of each building category and for selected major building components, i.e. structural system, building shell (walls, floors, roofs, openings, etc.), building materials and methods of construction.

The diversity of the existing building fabric in relation to preservation policies and all other interrelated constraints that need to be equally valued, make decisions upon the accurate intervention measures, a very strenuous procedure. For that reason, all of the above interdisciplinary data was incorporated in a concise table, a sample of which is presented in Table 2, that indicates the encoded intervention guidelines, along with the building evaluation, audit and energy efficiency obligation for each building category.

For example, on the section of thermal improvements of structural components, the energy efficiency obligation for each category regarding the exterior walls (which is probably the most challenging), is as follows: For K1 and K2 and all wall types (stone, brick, timber framed), there is no obligation for thermal insulation or energy performance upgrade. On K2 and K3, buildings with plastered walls are obliged to comply with the U-values set by the EPB regulation. In cases where the walls bear no plaster on either the internal or external surface, application of thermal insulation on any of the two sides is examined. If, however, a justified and reasoned incapability to conform is submitted, there is no obligation for thermal insulation application. K5 should comply with minimum EPB requirements.

4. DISCUSSION

It is well known that the worst enemy of old buildings is depreciation and dereliction, as it leads to degradation and finally to irreversible destruction. Thus, they need to be upgraded and enhanced to respond to contemporary needs and energy requirements. The energy efficiency upgrades of historic buildings constitute a complex work, as many underlying issues need to be addressed. They demand a multidisciplinary approach, expert knowledge and proper guidance. Preservation regulations, on the other hand set even more limitations that often discourage restoration and energy improvement works. All of the above account for reluctance or bad practices regarding energy efficiency retrofitting improvement works during restoration. Finally, the most difficult matter is that historic buildings possess many attributes that contribute to their uniqueness. Each case may defy old practices.

Even though the scientific team completed the project prior to the release of CSN EN 16883:2017 [5], there are many similarities in the general approach as well

as in specific areas, such as the building survey and assessment. However, the biggest challenge and innovation on the Greek work was the classification of the pre-1955 existing building stock. The classification was developed to facilitate and guide all involved stakeholders, community planning administrators and government agencies on auditing and assessment procedures. In addition to that, the technical guidelines will be used as a helpful tool and advice for architects, conservators, as well as owners, in order to address successfully restoration and energy improvement works, with respect to the building's inherent qualities and potential, place, climate and cultural values.

The Technical Guidelines for the energy efficiency retrofitting intervention on existing buildings constructed prior to 1955, have been released and after validation will be implemented in the recast of the Greek EPBD. The proposed interventions should follow the established methodological and legislative framework for calculating the energy performance for buildings and building elements and be complied with the established minimum requirements excluding cost-optimality. Implementation of the Technical Guidelines will be according and in regard to established Greek regulations and building codes and consists of four distinct stages: a) building inspection and evaluation stage (recording and assessment of a building's architectural value and structural condition), b) concept-design stage (schedule of proposed interventions), c) approval of evaluation and design proposal including in-situ audit-procedures by authorities, and d) final design and issuance of building permit stage, followed by site inspection and supervision of the implementation works.

5. REFERENCES

- [1] 17GA 2011/38 Energy and Conservation and Sustainable development, The 17th General Assembly of ICOMOS.
- [2] K. Dol, M. Haffner 2010, Housing Statistics in the European Union 2010. Ministry of the Interior and Kingdom Relations, The Hague, The Netherlands.
- [3] https://www.buildingcert.gr/N4122_2013.pdf
- [4] <http://www.ypeka.gr/LinkClick.aspx?fileticket=5nRUKLGIL8E%3D&tabid=506&language=el-GR>
- [5] CEN Conservation of cultural heritage – Guidelines for improving the energy performance of historic buildings, CSN EN 16883:2017.

A method to assess the potential for and consequences of energy retrofits in Swedish historic districts

B. Moshfegh¹, P. Rohdin¹, V. Milic¹, A. Donarelli², P. Eriksson² and T. Broström²

¹ Division of Energy Systems, Department of Management and Engineering, Linköping University, Sweden.

² Department of Art History – Conservation, Uppsala University, Sweden.

Abstract – This paper presents and demonstrates a multidisciplinary method to assess the potential for and consequences of improving the energy performance in a stock of historic buildings. The key elements in the method are categorization of the building stock, identifying targets, assessment of measures, and life cycle cost optimization. The method is applied on the historic building stock of the world heritage town of Visby. Based on a systematic categorization, building archetypes are selected to represent the whole building stock. The software OPERA-MILP provides a cost-optimal energy renovation strategy for each category of buildings. In a second step, restrictions with respect to the protection heritage values are introduced. The method can be used for energy planning in large building stocks as it provides a tool to show the consequences in terms of energy use, for different levels of restrictions.

Keywords – energy, retrofit, historic buildings, method

1. INTRODUCTION

Buildings account for nearly 40 percent of total energy use in Sweden. The existing building stock therefore constitutes an important part of the national pursuit of reduced energy use. The European Energy Efficiency Directive (EED) and the Swedish National Renovation Strategy emphasize the importance to identify sustainable renovation and energy efficiency strategies not only for individual buildings but also in the building stocks.

The Swedish research project ‘Potential and Policies for Energy Efficiency in Swedish Historic Buildings’ is a transdisciplinary collaboration between the Division of Energy Systems, Linköping University and the Department of Art History – Conservation at Uppsala University. The project aims to investigate the interdependency between political targets for reducing energy use and effects on the built heritage in five Swedish historic districts – two small towns, one rural district and two bigger cities – using different targets for energy efficiency and preservation.

The aim of this paper is to present and demonstrate a multidisciplinary method to assess the potential for, and consequences of, improving the energy performance in a stock of historic buildings. The key elements in the method are categorization of the building stock, identifying targets, assessment of measures, and life cycle

cost optimization. The method allows for an interaction between the quantitative assessment of the techno-economic potential and the qualitative assessment of vulnerability and other risks. Through a multidisciplinary dialogue and iteration it is possible to arrive at a solution that best balances energy conservation and building conservation in a given decision context.

This paper will present results from one case study and show how they can be used for planning and policies at a district level.

2. OVERALL METHOD

2.1 OVERVIEW

The method has been described in a previous publication [1], see Figure 1. The following is a short summary. The method is a synthesis of methods and practices from the building industry and from building conservation, which allows for the impact on heritage values to be weighed against techno-economic factors:

- 1) Categorisation of the building stock to identify representative building types;
- 2) Definition of targets for energy performance as well as for preservation of historic buildings;
- 3) A first assessment of risks and benefits based on a gross list of measures for energy efficiency;
- 4) Life cycle techno-economic optimisation to find the best combination of measures selected in step 3.

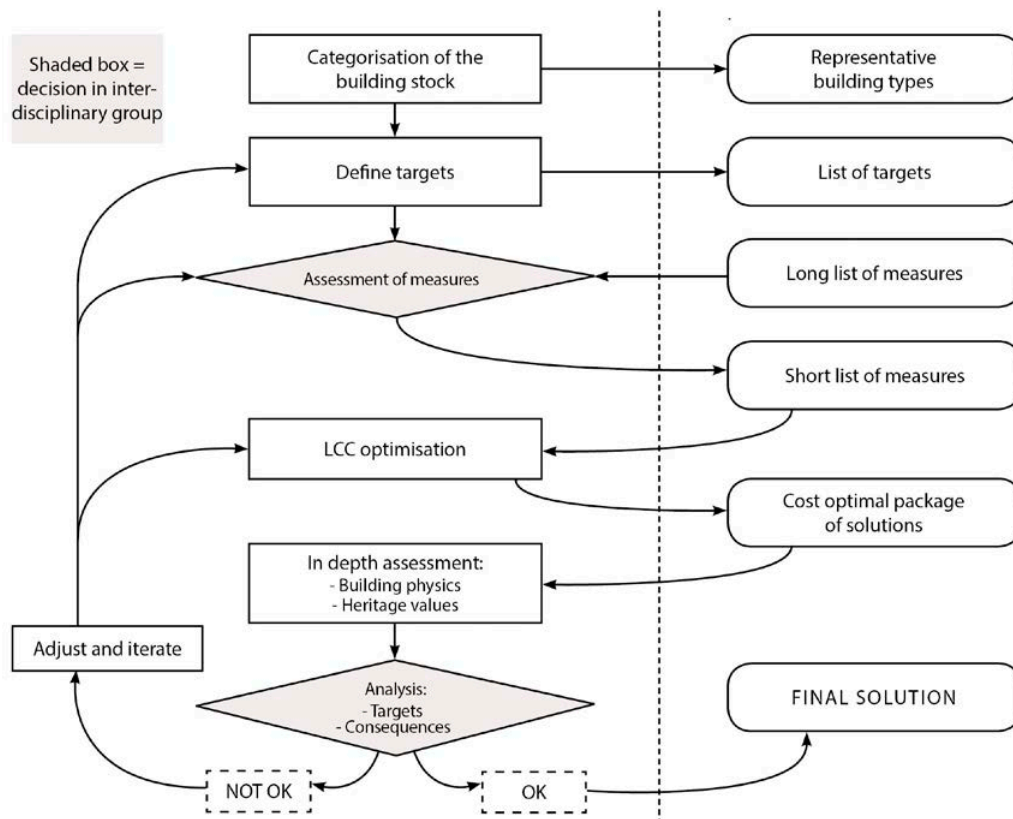

Figure 1. Flow chart illustrating the proposed method.

- 5) Risk assessment with respect to cultural heritage value and building physics;
- 6) Analysis of the consequences in relation to the targets;
- 7) Iterative adjustments of measures and targets.

2.2 CATEGORISATION OF THE BUILDING STOCK

The method for the categorisation of the building stock has been developed and validated within the Swedish national project 'Potential and Policies for Energy Efficiency in Swedish Historic Buildings' [2] and in the European project EFFESUS[3]. The categorisation is mainly based on the physical characteristics of the buildings:

- Number of floors;
- Floor area;
- Number of adjoining walls (perimeters);
- Type of building envelope construction.

For an in-depth analysis, subcategories can be based on year of construction, type of use, predominant energy supply and heat distribution system, and legal protection.

Existing databases are the primary sources for the building inventory, but it may be necessary to gather additional data in situ. The accessible data may be a limiting factor, this requires a flexible approach in order to adapt the categorization to data availability. All sources of building information need to be evaluated with regards to reliability, accessibility, variation rate and overall quality.

Based on the collected building data, the categorisation is carried out step by step:

Number of floors – the buildings are clustered according to their number of floors. Depending on the characteristics of the building stock, segmentation can vary. It is important to limit the number of categories.

Adjacent buildings – divide the buildings according to the number of adjoining walls; detached, semi-detached and terraced. This might not be a straightforward analysis and may require determining the percentage of covered wall surface rather than number of walls.

Floor area – calculate the floor area (unless available). This will not affect the number of categories but is used to determine the buildings' physical properties.

Define volume – generalised calculations based on available data may be needed.

Buildings with common physical features can vary in terms of size; outliers are excluded from the categories. Subcategories can be added to the physical categories, taking increasing levels of details into account, without having to develop new physical building models. This will enable a deeper analysis of technical and historic characteristics.

To represent each category, typical buildings are defined. They can be either real *sample buildings*, or generic *archetype buildings*. The typical buildings

are defined with respect to the medium values of volume, floor area and other relevant characteristics within each category.

2.3 TARGETS

For the buildings representing the building stock of Visby, three scenarios have been chosen to illustrate the approach of the proposed methodology. The scenarios are based on different degrees of restrictions for changing the building envelopes in accordance with the local building regulations for the case study area. The first scenario is an *optimal LCC solution* (see below), the second scenario is a *balanced scenario* with limited thickness of floor and roof insulation, and the third scenario which is the most *restricted scenario*, prohibits change or adaptation of windows as well as insulation of external walls.

2.4 TECHNO-ECONOMIC OPTIMISATION

OPTimal Energy Retrofit Advisory-Mixed Integer Linear Program (OPERA-MILP) is an LCC optimization software with low computational resource usage developed at the Division of Energy Systems at Linköping University, Sweden, [4]. By the use of OPERA-MILP a cost-optimal energy renovation strategy is selected, corresponding to a month, in the calculations of the building's energy balance. Milić et al. [5] found that the accuracy with OPERA-MILP calculations is satisfactory, in terms of building power demand and energy use, by comparison with the established building energy simulation software IDA ICE. The cost-optimal energy renovation strategy can be obtained for different energy targets by setting the allowed building energy use to an arbitrary value. OPERA-MILP has been used successfully in several scientific investigations with the objective of minimizing building LCC, e.g. [6, 7].

In OPERA-MILP a specified period of time is set in the optimization. Consideration is taken for cost related to investment in heating system and Energy Efficiency Measures (EEMs), as well as energy costs and maintenance costs for building components, see Eq. (1).

$$LCC_{total} = LCC_{investment} + LCC_{energy} + LCC_{maintenance} - RV \quad (1)$$

where LCC_{total} presents the total LCC during the optimization period, $LCC_{investment}$ are total investment costs for EEMs and heating system, LCC_{energy} is the energy cost during the specified period of time, $LCC_{maintenance}$ is the maintenance cost for building components and RV presents the residual value of the investment costs connected to EEMs, heating system and also maintenance performed on the building. The implemented heating systems are district heating, groundwater heat pump, wood boiler and electric radiator. Implemented EEMs include window replacement, weather-stripping, floor insulation, roof insulation and external wall insulation on the inside and outside of the wall. Costs for the various measures are calculated based on cost functions, which are developed using up-to-date manufacturer data [4]. The energy balance of the building includes heat losses in form of transmission, ventilation and infiltration and domestic hot water use. Solar gain and internal heat generation, e.g. from electrical appliances and building

occupants, is also included. The building power demand is calculated based on a preset indoor temperature, the outdoor design temperature for the specific building and location, and the total heat losses of the building. In addition, the power demand for domestic hot water is taken into account.

2.5 ASSESSMENT OF HERITAGE VALUES AND VULNERABILITY TO CHANGE

Historic buildings are buildings with certain heritage significance. In order to take care of the values that constitute the significance of the buildings, we need to identify the character defining elements. In order to handle building stocks and categorised buildings, we need a simplified approach to identify heritage significance and to point at and select the character defining elements in order to assess the impact of change due to different techno economic scenarios [8]. The general approach could be described as follows:

Identify the main values that are the basis for the heritage significance of a building categories or typical building.

Identify the character defining elements (visual, material and spatial) that contribute to and reinforce the values and heritage significance.

Assess the impact of change by using a scale for benefits and risks with respect to each proposed measure.

In this case we used the local building regulation to identify the main values and character defining elements of the buildings, such as the exterior façade, windows and roof materials. This was in turn used to more specifically define the scenarios in terms of which measures can be allowed or not.



Figure 2. The historic district of Visby is a UNESCO world heritage with around 5000 inhabitants and 1400 buildings. Photo: Uppsala University.

3. CASE STUDY – VISBY

Visby is a UNESCO world heritage city located on the island of Gotland in the Baltic Sea. Around 5000 people live in the historic district and there are around 1400 buildings historic district, see Figure 2. According to UNESCO [9] it is a typical example of a north European medieval walled trading town which preserves a townscape and assemblage of high-quality ancient buildings that illustrate graphically the form and function of this type of significant human settlement. Even though the character of the town is medieval, there is a wide range of historic buildings representing various time periods and construction types. Visby is representative of many European historic city centres where the building constructions and conservation aspects set a limit to energy performance. Tourism is important and thus preserving buildings and townscape is an essential factor for a sustainable management of the city and its built heritage. The municipality has set very high standards for energy efficiency and they have launched a new plan for the historic centre where energy aspects are integrated with a general plan for building conservation.

4. RESULTS

4.1 CATEGORISATION

The categorisation of the building stock in Visby resulted in six categories, see Table 1. These six categories represent 87 % of the buildings and 70 % of the total building volume. The excluded buildings are mainly large non-residential buildings. Based on each building category, a typical building (also referred to as an archetype) was modelled. The typical building was based on the medium values of the buildings in each category.

Table 1. The categorisation of the building stock in Visby

	Category number					
	1	2	3	4	5	6
<i>Floors</i>	1	1	1	≥2	≥2	≥2
<i>Boundaries</i>	Detached	Semi-detached	Terraced	Detached	Semi-detached	Terraced
<i>No. of buildings</i>	364	212	41	108	113	82
<i>No. of buildings by onstruction*</i>	w 309/s 55	w 166/s 46	w 25/s 16	w 33/s 75	w 30/s 83	w 18/s 64
<i>Average volume (m³)</i>	300	320	425	1380	1300	1350
<i>Share of stock</i>	14 %	8 %	2 %	17 %	17 %	12 %

4.2 OPTIMISATION

For the optimisation, the six categories were divided in two subcategories according to their construction; wood and stone, i.e. 1w/1s, 2w/2s etc., resulting in twelve categories. The optimisation procedure was carried out on typical

buildings representing the building stock, and measures were selected according to the three different scenarios described above: optimal, balanced and restricted. EEM's that were considered risky with respect to moisture problems were removed.

The result of the optimisation was presented by grouping the subcategories as 1–3w/s (one-family houses) and 4–6w/s (apartment buildings). The results in terms of selected EEM's and energy use are exemplified in Table 2. The optimal scenario shows what is optimal from a techno-economic point of view. The balanced and the restricted scenarios show how much the energy use is increased due to the restrictions.

Table 2. Optimisation results exemplified by building categories 1w, 1s, 4w and 4s

Building category	Target scenarios					
	Optimal		Balanced		Restricted	
	EEM's	Energy use (kWh/m ² year)	EEM's	Energy use (kWh/m ² year)	EEM's	Energy use (kWh/m ² year)
1w	Roof ins: 12 cm Floor ins.: 26 cm Wall ins: - Windows: 2-panes	109.1	Roof ins: 12 cm Floor ins: 16 cm Wall ins: - Windows: -	131.2	Roof ins: 12 cm Floor ins: 16 cm Wall ins: - Windows: -	131.2
1s	Roof ins: 10 cm Floor ins: 24 cm Wall ins: 20 cm Windows: 2-panes	70.8	Roof ins: 12 cm Floor ins: 16 cm Wall ins: 16 cm Windows: -	101.8	Roof ins: 6 cm Floor ins: 16 cm Wall ins: - Windows: -	252.3
4w	Roof ins: 10 cm Floor ins: - Wall ins: - Windows: 2-panes	97.3	Roof ins: 12 cm Floor ins: - Wall ins: - Windows: -	113.0	Roof ins: 12 cm Floor ins: - Wall ins: - Windows: -	113.0
4s	Roof ins: 10 cm Floor ins: - Wall ins: 16 cm Windows: 2-panes	71.3	Roof ins: 10 cm Floor ins: - Wall ins: 16 cm Windows: -	91.0	Roof ins: 12 cm Floor ins: - Wall ins: - Windows: -	204.5

Based on the total building volume for each category, the results from the typical buildings in Table 2 are extrapolated to reflect the effects at a building stock scale, see Figure 3. The biggest differences between the scenarios appear in category groups 1–3s and 4–6s, which are connected to the thermal properties of stone constructions. Insulation of exterior walls does not pay off in the wooden buildings, thus there is a relatively small difference between the scenarios for the wooden buildings.

The optimal scenario results in suggestions on changing windows in all typical buildings which would be in conflict with the local building regulation and is regarded as having high negative impact on heritage values. The balanced and restricted scenarios suggest energy improving measures, such as improving roof and floor insulation, as well as interior insulation on exterior walls. These measures do not affect the character defining elements.

On a district scale, it can be seen that imposing restrictions would have little effect on the energy use of wooden buildings. As pointed out above, the stone

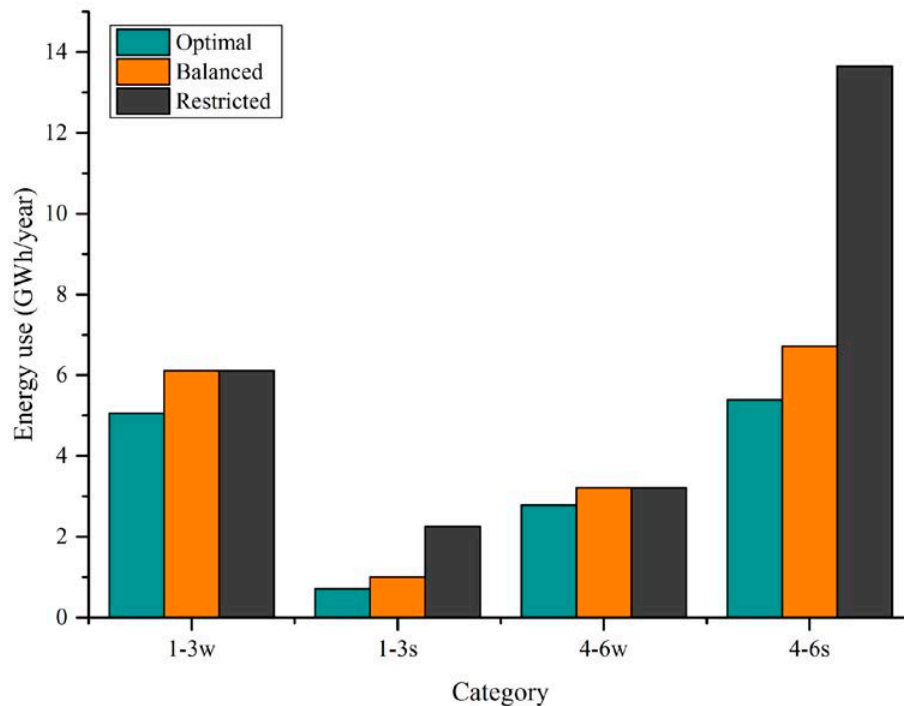

Figure 3. Total energy use (GWh/year for each target scenario) divided into four building categories.

buildings (1–3s and 4–6s) have a bigger energy saving potential than the groups of wooden buildings. On a district scale, however, the apartment buildings (4–6s) dominate, see Figure 3. The results also indicate that if wooden buildings should be improved in energy performance, this requires change of windows, a highly restricted measure in the building regulations for the historic district of Visby. There is a considerable potential to save energy with the balanced scenario in the stone buildings. This implies that continuing research on possible EEMs that comply with the designated heritage values in Visby, is needed.

5. CONCLUSIONS

We suggest that the presented method can be used for planning and policy development in large stocks of historic buildings. Through the integration of quantitative and qualitative methods in a multidisciplinary dialogue, the method provides a tool to show the consequences, in terms of energy use and impact on heritage values, for different levels of restrictions, not only for single buildings but for the district as a whole.

This methodological approach illustrates a possible path to the design of strategic programmes for energy saving on building stock level through the comparison of different target scenarios. In these target scenarios we have considered best LCC as well the local building regulations for our case study area. The results show that there are different energy saving potentials in the different categories of the building stock. These differences could be used as a basis to develop differentiated and specific information to the owners.

In the next step of the project 'Potential and Policies for Energy Efficiency in Swedish Historic Buildings', the method will be applied to different and much larger building stocks in Sweden in order to facilitate better planning and more precise policies.

6. REFERENCES

- [1] Broström, T., Eriksson, P., Liu, L., Rohdin, P., Ståhl, F., Moshfegh, B. (2014). *A Method to Assess the Potential for and Consequences of Energy Retrofits in Swedish Historic Buildings*. Journal of the Historic Environment. Vol 5 Issue 2 2014.
- [2] Broström, T., Donarelli, A., Berg, F. (2017). *For the categorisation of historic buildings to determine energy saving*. AGATHON International Journal of Architecture, Art and Design, 1: 135–142.
- [3] Brostrom, T., Bernardi, A., Egusquiza, A., Frick, J., Kahn, M., A method for categorization of European historic districts and a multiscale data model for the assessment of energy interventions. 3rd European Workshop on Cultural Heritage Preservation, Bolzano, September 2013.
- [4] Gustafsson, S-I. (1998). *Mixed integer linear programming and building retrofits*. Energy and Building, 28: 191–196.
- [5] Milić, V., Ekelöv, K., Moshfegh, B. (2018). *On the performance of LCC optimization software OPERA-MILP by comparison with building energy simulation software IDA ICE*. Building and Environment, 128: 305–319.
- [6] Liu, L., P. Rohdin, P., Moshfegh B. (2016). *LCC assessments and environmental impacts on the energy renovation of a multi-family building from the 1890s*. Energy and Buildings, 133: 823–833.
- [7] Liu, L., P. Rohdin, P., Moshfegh B. (2018). *Investigating cost-optimal refurbishment strategies for the medieval district of Visby in Sweden*. Energy and Buildings, 158: 750–760.
- [8] Eriksson, P. Hermann, C, Hrabovszky-Horvath, S. and Rodwell, D., EFFESUS Methodology for Assessing the Impacts of Energy-Related Retrofit Measures on Heritage Significance. Journal of the Historic Environment. Vol. 5 Issue 2 2014.
- [9] UNESCO World Heritage (1995) <http://whc.unesco.org/en/list/731>

Heat pumps for conservation heating in churches

P. Klenz Larsen

The National Museum of Denmark, Department of Environmental Archaeology and Materials Science, Lyngby, Denmark. Email: poul.klenz.larsen@natmus.dk

Abstract – A novel concept for electrical heating was tested in three different medieval churches in Denmark. An air-to-air heat pump was installed in combination with direct electric heating in the pews. The heat pump was controlled by a hygrostat to ensure a moderate relative humidity in the church. Heating to a few degrees above the outside average temperature also in summer kept the RH below 70 % at all times. The purpose was to prevent biological degradation by fungus or insects. Intermittent heating for services was provided by the pew heaters, with sufficient power to raise the temperature rapidly within a few hours. The cooling unit for the heat pump was installed in the attic to screen against the noise and the visual impact, which otherwise excludes this technology in historic buildings. The best performance was achieved for a building with a thermally insulated ceiling and double glazed windows. There is a potential for energy savings by the combination of direct electric heating and a heat pump.

Keywords – heat pump, conservation heating, historic church, energy efficiency

1. INTRODUCTION

1.1 INTERMITTENT CHURCH HEATING

Many rural churches in Denmark are only used a few times during the month. There is no need for constant heating to comfort temperature in winter, so intermittent heating is common practice. Heating for services is provided by electrical heating systems with heating elements mounted below the seats in the pews. There is sufficient power to raise the temperature rapidly within a few hours. The heating is turned off in between activities to save energy. This heating practice gives a reasonable thermal comfort for staff and congregation on the one hand, and is gentle for the building and the wooden furniture on the other hand [1].

1.2 BIOLOGICAL DEGRADATION

A consequence of keeping the church cold is that the relative humidity is high all year, ranging between 70 %RH and 90 %RH. This is not due to excess humidity from human activity, but is a natural result of the low temperature. A permanent high RH favours insects such as textile moths and wood boring worms, and the risk of mould and fungus is also large. Since the use of most fungicides and pesticides is abandoned, climate control is the only alternative method for preventing biological degradation. The acceptable range for RH is 60–70 %, because the interiors were never adapted to lower RH [2].

1.3 CONSERVATION HEATING

Conservation heating is an established practice for keeping a moderate RH in historic houses in cold regions [3]. This control strategy is rather energy consuming, because the heat loss from historic buildings is large and the potential to improve the thermal performance is limited. In a case study of three houses in the UK, the annual energy consumption was 40–50 kWh/m³ for controlling the RH within 50–65 % [4]. Heat pump technology is an attractive method for conservation heating, because it is much more efficient than direct electric heating [5]. A study of a medieval church in Estonia showed that conservation heating with a heat pump used 3.7 kWh/m³ in a year to keep 70 %RH [6].

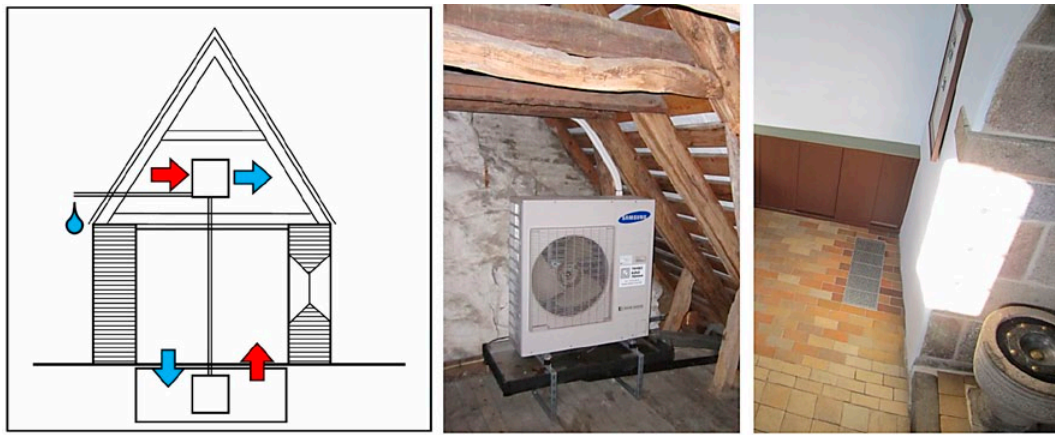

Figure 1. Principal sketch of the heat pump installation in the church (left). To the right a view of the cooling unit in the attic and the inlet in the floor (Erslev Church). Photos: Poul Klenz Larsen.

2. EXAMPLES

2.1 HEATING SYSTEM

An air-to-air heat pump was installed for conservation heating in three different churches. The cooling unit was located in the attic of the church and not outside the building (Figure 1). The water condensing at the cooling coil was collected in a steel tray with a drain to the outside. The drain was protected against frost by a thermostatic controlled heating wire. An underground space in the nave was reused for the heating unit, with inlet and outlet grills in the floor. The pipes connecting the cooling- and heating units were installed in an old smoke pipe, which was embedded in the chancel wall. There was a minimal visual impact of the technical equipment.

Low temperature radiant heating elements were mounted below the seats in the pews for comfort heating. The heating power for this combined heating system is given in Table 1. The pew heaters were controlled by thermostats and a timer to start the heating a few hours before services. The heat pump had hygrostatic control with an upper limit at 72 %RH.

2.2 TEST CHURCHES

The three churches are situated in West Jutland and dates to approximately 1200. The buildings have a similar construction with granite walls, lead roof and a flat ceiling of wood planks (Figure 2). The ceiling has thermal insulation in different thicknesses given in Table 1. The windows have single glazing in Vemb and Øster Jølby, but double glazing in Erslev church. The volume of the nave and chancel is 250 m³ or 500 m³. There is a small unheated porch to each church.

Table 1. Data for the three test churches

	<i>Vemb</i>	<i>Øster Jølby</i>	<i>Erslev</i>
<i>Volume (nave and chancel)</i>	250 m ³	250 m ³	500 m ³
<i>Area (wall & ceiling)</i>	200 m ²	200 m ²	350 m ²
<i>Window glazing</i>	single	single	double
<i>Thermal insulation (ceiling)</i>	30 mm	200 mm	100 mm
<i>Heat pump power</i>	12 kW	8 kW	12 kW
<i>Electric heat power</i>	14 kW	15 kW	26 kW



Figure 2. Exterior view of Erslev Church (left) and Øster Jølby Church (right). Photos: Poul Klenz Larsen.

3. RESULTS AND DISCUSSION

3.1 CLIMATE CONTROL

The climate record for two years in Vemb church is given in Figure 3. The relative humidity in the nave (blue) was 65–75 %RH most of the year except for a few episodes in winter. During heating episodes for services the RH dropped to 50–60 % for a few hours. The temperature in the nave (red) was between 8 °C in winter and 23 °C in summer, which was higher than in the attic most of the year. In July and August the attic (yellow) reached more than 30 °C on sunny days. In winter the attic was above 0 °C most of the time, and the RH was rarely above 90 %RH (green). It is remarkable that the RH never reached 100 %RH, which has been observed in many other churches.

Figure 4 shows the climate record for one week in October 2014. The dew point temperatures are given below in the diagram. There was a temperature rise of 2–3 °C in irregular intervals during the week, which drove the RH down below 70 % in a few hours. For every heating cycle the dew point temperature rose 2–4 °C. The increased water content of the air induced a further increase of temperature to lower the RH. The increase in dew point was not caused by human activity. Porous materials like wood or plaster responded to the RH drop by emitting water vapour to the air. The surplus of water vapour was gradually removed to the outside by ventilation. The humidity buffering by the interior surfaces of the building is an inherent disadvantage of heating for humidity control.

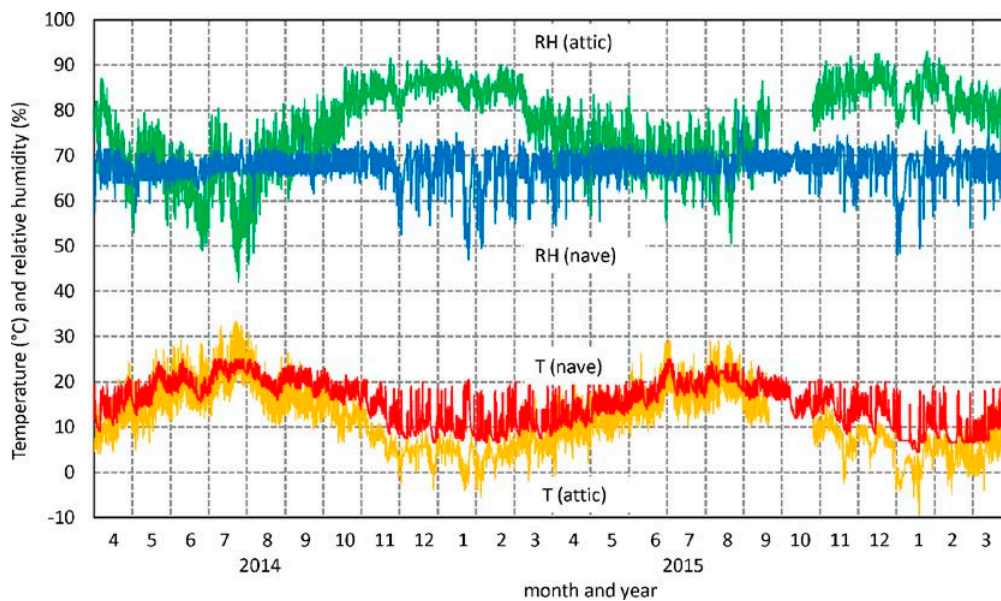

Figure 3. Two years climate record from Vemb Church.

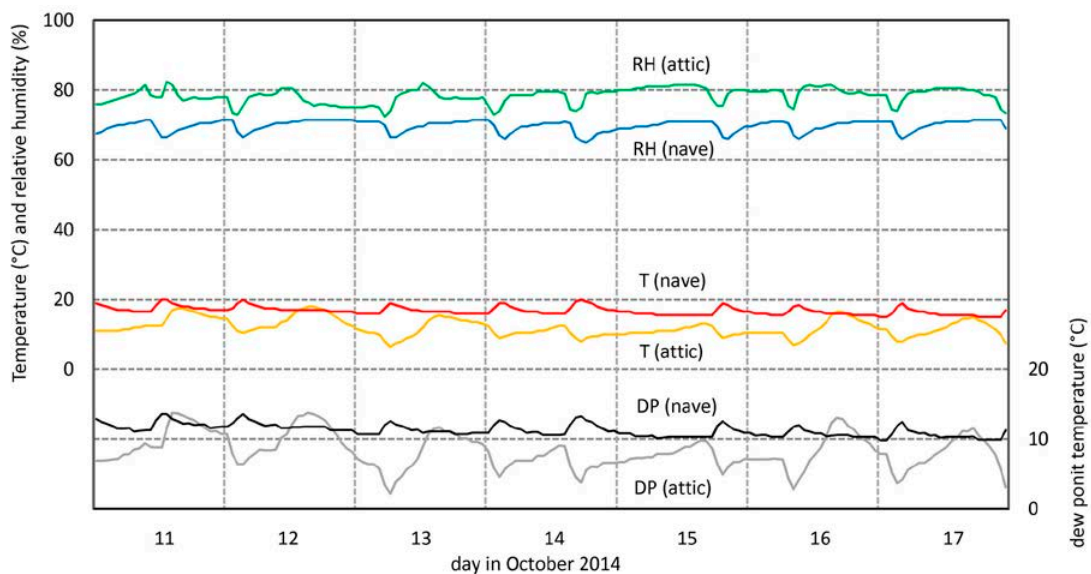

Figure 4. Climate record over one week in October 2014 from Vemb Church.

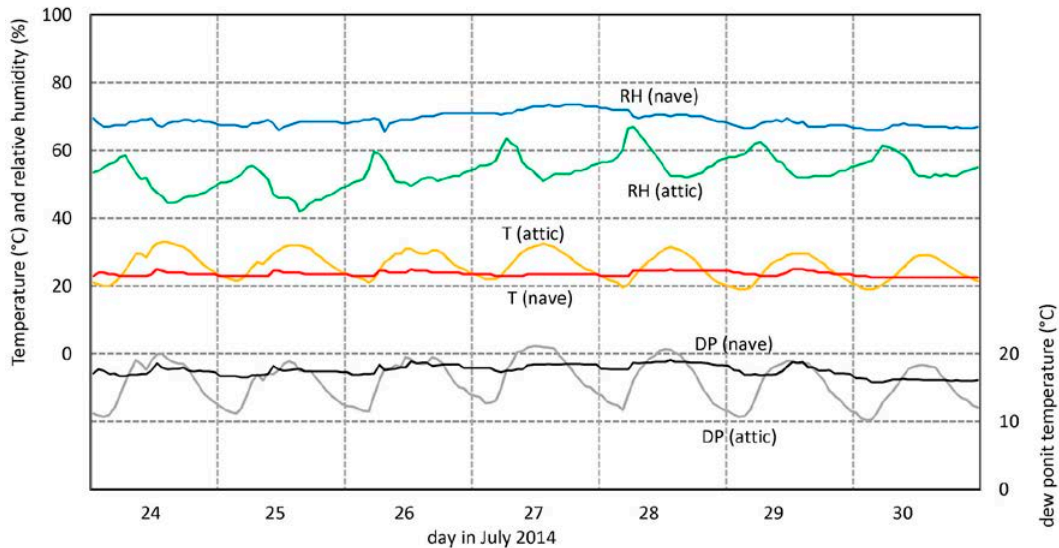

Figure 5. Climate record over one week in July 2014 from Vemb Church.

The situation in the attic was quite the opposite. For every heating cycle there was a drop in temperature, and an even larger drop in dew point temperature. This was due to condensation at the cooling coil, which removed water vapour from the air in the attic. The effect of dehumidification was so strong that there was a simultaneous drop in RH, despite the lowering of the temperature. After each heating cycle the dew point gradually approached the ambient conditions by natural ventilation. The rather slow ventilation rate is indicated by the slope of the dew point line. It is likely that the periodical dehumidification kept a lower RH in the attic during the year.

Figure 5 shows the climate record for one week in July 2014. The temperature in the nave was almost constant at 22–23 °C. The heat pump was only in operation a few times to keep the RH below 70 %, and the dew point in the nave was also rather constant. The climate in the attic was much more unstable. The temperature ranged between 20 °C in the night and 30 °C during the day, and the RH was between 40 % and 70 %. The dew point went between 10 °C and 22 °C in a daily cycle. The climatic variations were not caused by the heat pump, but related to the ambient conditions. The cooling unit did not introduce a more stressful climate in the attic than before. It is remarkable how the dew point in the nave was not affected by the outside variations. The natural ventilation must have been quite low, but the Air Exchange Rate was not measured. The possible effect of adaptive ventilation was also not considered in this study.

3.2 ENERGY CONSUMPTION

Figure 6 gives the monthly energy consumption in Vemb church over two years. The heat pump was in operation all year, whereas the direct heating was mainly used in the winter season. The energy needed for the summer heating was not significant in 2014, but in 2015 it was nearly half of the energy used for winter heating. The summer temperatures were not much different, so there is no obvious explanation for the poor performance in 2015.

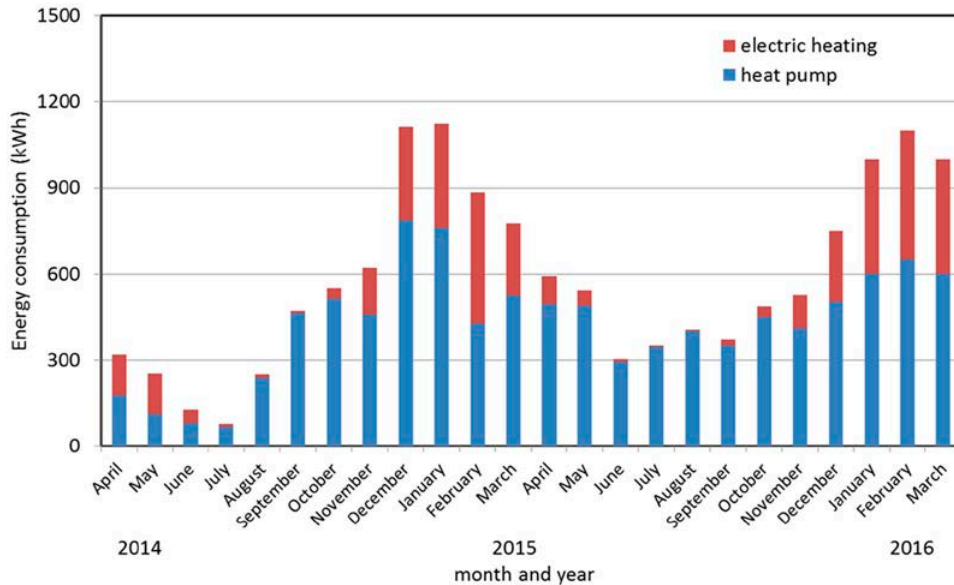

Figure 6. Energy consumption over two years in Vemb Church.

Table 2. Annual energy consumption

	<i>Vemb church</i>	<i>Øster Jølby church</i>	<i>Erslev church</i>
<i>Electric heat</i>	7,7 kWh/m ³	5,6 kWh/m ³	5,5 kWh/m ³
<i>Heat pump</i>	21 kWh/m ³	16 kWh/m ³	11 kWh/m ³
<i>Time period</i>	2013–2017	2016–2017	2016–2017

The annual energy consumption for all three churches is given in Table 2. It also includes lighting energy, which was little compared to heating, and eventually ended up as heat. The heat pump in Vemb used 21 kWh/m³ in a year to maintain RH around 70 %. In Øster Jølby it used 16 kWh/m³ although the churches are equal in size. The difference is related to the thickness of the thermal insulation in the ceiling. Vemb church has only 30 mm of mineral wool, whereas Øster Jølby has 200 mm. This difference accounts for a higher heat loss in Vemb than in Øster Jølby.

The heat pump in Erslev used 11 kWh/m³ in a year, which was only 2/3 of Øster Jølby. The energy use was monitored over the same period from May 2016 to May 2017, and the two churches are located within a distance of two kilometres, so there was no difference in the ambient conditions. The surface area of the walls and ceiling was approximately 200 m² in Øster Jølby and 350 m² in Erslev, so the heat loss per area was 20 kWh/m² and 15 kWh/m². The energy consumption was not much related to the difference in size of the buildings. The heat loss by natural ventilation was presumably less in Erslev church due to the double glazed windows. The effect of natural ventilation was not monitored in this study.

4. CONCLUSIONS

A novel application of an air-to-air heat pump was tested in three medieval churches in Denmark. The heat pump was used for conservation heating of the nave and chancel with hygrostatic control to 70 %RH all year. The purpose was

to prevent biological activity such as fungus or insects. The energy consumption depended on the thermal insulation in the ceiling and the natural ventilation. The best performance was 11 kWh/m³ for Erslev Church, with 100 mm insulation in the ceiling and double glazed windows.

Intermittent heating for comfort was mainly supplied by electrical heaters in the pews. The heating power for intermittent heating was twice that for the heat pump, to ensure a fast rise of temperature and to keep the energy use as low as possible. Heat pumps can also be retrofitted in churches with an existing electrical heating system. There is a large potential for energy savings by the combination of direct electric heating and a heat pump.

The main challenge of installing an air-air heat pump in a historic church is to find a place for the cooling unit. The attic has proven to be a suitable place for screening against the noise and the visual impact. This unorthodox location relies on heat transmission and radiation through the roof, because the natural ventilation of the attic is not enough to supply the heat. A side effect of the application is a lowering of the RH in the attic by condensation on the cooling coil.

5. ACKNOWLEDGEMENTS

The work was carried out in collaboration with architect Knud Fuusgaard, electrical engineer Steffen Pedersen, Kamp Kirkevarme Aps and Ivan Kruse, Thybo Kølleteknik A/S. The heating installations were funded by the congregations. We sincerely appreciate the support of the local communities.

6. REFERENCES

- [1] P.K. Larsen. Climate control in Danish churches. Museum Microclimates, Proceedings of the conference in Copenhagen 19–23 November 2007, pp. 167–174.
- [2] P.K. Larsen, T. Broström, L. Aa.Jensen. Energy and power demand for intermittent heating of churches. In Postprints from the conference Energy Efficiency in Historic Buildings, Visby, 9–11 February 2011, pp. 37–46.
- [3] R.H. Lafontaine. “Humidistatically-controlled heating: a new approach to relative humidity control in museums closed for the winter season. *Journal of the IIC Canadian Group*, 7, pp. 35–41.
- [4] N. Blades, S. Poupard, L. Barber. “Analysing the energy consumption of conservation heating systems at the National Trust.” *Journal of the Institute of Conservation*, 34:1, pp. 16–27. <http://dx.doi.org/10.1080/19455224.2011.556912>
- [5] T. Broström and G. Leijonhufvud. Heat pumps for conservation heating. In Proceeding for Nordic 8th Symposium on Building Physics in the Nordic Counties, Copenhagen, June 16–18, 2008, pp. 1143–1150.
- [6] M. Napp and T. Kalames. Energy use and indoor climate of conservation heating, dehumidification and adaptive ventilation for the mediaeval church in a cold climate. *Energy and Buildings* 108, pp. 61–71. Elsevier. <http://dx.doi.org/10.1016/j.enbuild.2015.08.013>

Design of indoor climate and energy efficiency of the medieval Episcopal Castle of Haapsalu museum

T. Tark¹, T. Kalamees², A. Rodin¹, E. Arumägi² and M. Napp²

¹ Hevac OÜ, Tallinn, Estonia. Email: teet.tark@hevac.ee, albert.rodin@hevac.ee

² Department of Civil Engineering and Architecture, Tallinn University of Technology (TTÜ), Tallinn, Estonia. Email: targo.kalamees@ttu.ee, endrik.arumagi@ttu.ee, margusnapp.mn@gmail.com

Abstract – The design of indoor climate in museums in historic buildings is a complex, multidisciplinary problem. The ruins of the medieval Episcopal Castle of Haapsalu in Estonia, are taken into use as a museum. This article presents the results of the designing of indoor climate using energy efficient technologies and field measurements.

Field measurements before design and mould growth on paintings showed the need for improvement of indoor climate. The interaction of indoor air and moisture performance of the building envelope was taken into account in a combined heat, air, and moisture simulation model in IDA-ICE software. The simulation model was calibrated based on field measurements. Simulations analysed performance of different indoor climate control strategies and different outdoor climatic conditions (typical year, warm summer, cold winter, humid autumn).

Simulation results showed that it is difficult to provide strict required indoor climate conditions for museums throughout the year only with passive measures, and indoor climate is strongly dependent of the outdoor climate. In addition, large thermal and moisture capacity of massive limestone walls influenced the indoor climate. Without an indoor climate system there is extensive indoor temperature and relative humidity fluctuation throughout the year. The final design solution includes room heating, humidification during winter, and dehumidification during summer and autumn to ensure suitable indoor climate.

Based on the developed design solution, renovation works started in autumn 2017. The museum will be opened again in 2019, when the museum visitor centre for the Middle Ages exhibition is ready for year-round use.

Keywords – indoor climate; energy simulations; museums; monumental buildings, building physics

1. INTRODUCTION

The design of indoor climate in museums is a complicated and multidisciplinary problem. Integrated design is needed to guarantee the conservation of objects and architecture as well as to reach high performance in energy efficiency, indoor climate and moisture safety in building physics. The solution should fulfil the need for preservation of interior objects and the building itself, as well as providing appropriate climate conditions for human comfort. Indoor climate is strictly conditioned in modern museums [1].

It is popular to accommodate museums in historic monumental buildings that also have heritage value. Usually, these heritage buildings were not originally built for being museums. Therefore, in designing suitable indoor climate in historic buildings, it is necessary to pay extra attention to using the space for building service systems. The building's massive walls with large thermal transmittance and large heat and moisture capacity need to be taken into account. Poor indoor climate design can cause damage to the artefacts in a museum [2]. The deterioration of wooden objects [3,4], mould growth [5], and indoor air pollution [6] can occur. There have been many case studies on museums in historic buildings classified as monuments. Schellen and Martens [7] conducted a case study in the Netherlands and investigated the indoor climate and HVAC systems in local museums housed in historic buildings. In their study, Kramer et al. [8] showed how different ASHRAE's museum climate classes influence energy use and protect artefacts. Arumägi et al analysed the renovation possibilities of indoor climate in the Old Observatory in Tartu [9]. A RH-sensitive heating and ventilation system was developed to keep the RH and temperature at target level.

For the preservation of collections in a museum, complex and large climate systems are needed. There are many possibilities to provide indoor climate in medieval buildings with valuable interiors [10,11]. Due to conservation, architectural or economic reasons, it is difficult or sometimes impossible to install these systems into historic buildings.

In this study, indoor climate systems were designed based on measurements and simulations for the museum in the Episcopal Castle of Haapsalu.

2. METHODS

2.1 BUILDING AND MEASUREMENTS

The Episcopal Castle of Haapsalu was built in the 13th century and it is one of the oldest castles in Estonia (Figure 1). It has massive walls typical of a medieval stronghold castle. The castle is located in the city centre of Haapsalu and today, it accommodates a museum and the dome church.



Figure 1. Episcopal Castle of Haapsalu. Photo: Hapsalu Castle (<https://www.salm.ee/>).

Indoor climate measurements in the castle were carried out in autumn 2015 to obtain data for the calibration of the indoor climate simulation model. Temperature and relative humidity (RH) were measured with HOBO U-12 001 data loggers with the interval of 15 minutes in total 9 locations: 3 located in the dome church, 2 in the castle cellar, 2 on the first floor of the castle, and one on the third floor of the castle.

2.2 SIMULATION

Since the envelope of the dome church has a massive heat and moisture capacity, it is essential to use dynamic computer simulation to calculate the church's indoor climate and energy usage. IDA Indoor Climate and Energy software was used for indoor climate and energy simulations. This software is meticulously validated, allowing the modelling of a multi-zone building, internal and solar loads, outdoor climate, HVAC systems, dynamic simulation of heat transfer and air flows. The software has also been used in many energy performance and indoor climate applications [12–14]. The comparison of the simulation model was done with outdoor measurements from October to November 2015 with good agreement in temperature and satisfactory agreement between the measured and simulated moisture content. Four different climate conditions were used to test how different climate conditions affect the indoor climate: average year, warm summer, humid autumn, and cold winter, Table 1.

Table 1. Simulation cases. Targets for indoor climate were: $t_i > 10$ °C and RH 40-70 %.

Simulation case	Outdoor climate				Heating			Ventilation		Humidification min: 40 %	Water surface 25 m ²	Water surface 4 m ²	People: 2x per day for 2 h
	Estonian TRY	Warm summer	Humid autumn	Cold winter	Winter +10 °C	Vent. supply 10 °C	Conservation heating 70 % RH	1 l/(s·m ²)	Day: 2.5 l/(s·m ²) Night: 0.3 l/(s·m ²)				
1	+	+	+	+	+	+		+			+		
2	+	+	+	+	+	+	+	+			+		
3	+	+	+	+	+	+		+				+	
4	+	+	+	+	+	+	+	+				+	
5		+	+		+	+			+	+	+		
6		+	+		+	+			+	+	+		+
7		+	+		+	+	+		+	+	+		+

Winter period heating of +10 °C was taken as a base line (case 1). Conservation heating was added to prevent the relative humidity to rise above the desired set point (case 2). When room relative humidity exceeded the given set point of 70 % RH, the heater would start to work to decrease the RH level in the room. Two different ventilation airflow rates were used in the different cases of simulations: constant airflow rate of 1 l/(s·m²) and variable airflow rates for day and night were used when 2.5 l/(s·m²) was used from 10:00 to 18:00 and during night, airflow rate of 0.3 l/(s·m²) was used. Different airflow rates were used to simulate more real conditions, where during day time, greater air change rate would be used

during museum visiting hours. A water surface was used to simulate the massive heat and moisture capacity and moisture transfer between the room and the walls. Water surface of 25 m² was received with the model calibration (cases 1 and 2). A water surface of 4 m² was used in two simulations to see how indoor climate and the energy consumption of climate control systems would change after a longer period of time when the massive walls have dried out (cases 3 and 4). Humidification was added to keep the minimum RH of 40 % in the room (cases 5-7). People were added to the simulation to see how their presence would change the indoor climate. Two groups of 20 people each were added to the simulations for two hours, from 11:00 to 13:00 and 14:00 to 16:00 (cases 6 and 7).

3. RESULTS AND DISCUSSION

3.1 INDOOR CLIMATE SIMULATIONS

The model was calibrated according to the field measurements that were carried out in the Castle of Haapsalu between the period from 24 October to 23 November 2015.

The calibration showed that there are few differences between the simulated and measured indoor temperature. Simulation temperature is slightly more affected by the change of outdoor temperature, but regardless of the fact that there is good agreement between the temperature of measured and calibrated model.

Table 2. Simulation results [15]

Case	Purpose	The main result
1	To determine the need of drying and humidifying systems	Highest room heating power was 60 W/m ² to maintain the indoor temperature of +10 °C. The highest heating power applied to the supply air was also with the cold climate, 35 W/m ² . Relative humidity on the other hand, is very unstable and lies between 18...100%. Simulations show great moisture transfer fluctuation between the room and walls and mainly influenced by the outdoor climate. The highest energy consumption is with cold winter, 151 kWh/(m ² •a).
2	Conservation heating	Annual average temperature increase is 1.3 °C and during the summer-autumn period when the RH is the highest, the average temperature increase is 2.2 °C Indoor RH was controlled throughout the year to keep it RH 70 % by heating the room. The energy consumption is the highest in cold climate, 190 kWh/(m ² •a)
3–4	Cases 1–2 after drying out of the massive lime-stone walls	Indoor temperature difference was virtually unnoticeable. Annual average moisture transfer from the walls to the room was reduced by 0.77 g/m ³ , from 0.83 g/m ³ to 0.06 g/m ³ and the annual RH was reduced by 7 %. Total annual energy consumption with supply air heating, room heating, and CH was reduced from 186 to 172 kWh/(m ² •a) (without drying or humidifying in air handling unit).
5	Variable air-flow: 2.5 l/(s•m ²) at the day time and 0.3 l/(s•m ²) at night	In summer, larger airflow rate during the day time increases the indoor temperature. The maximum indoor temperature is 28 °C in warm summer and above 24 °C, i.e. 25 % of the time in July. RH in the summer time is 37 % of time above 70 % and in the autumn 41 % of the time above 70 %. Annual energy consumption compared to simulation case 1 has increased from 132 kWh/(m ² •a) to 192 kWh/(m ² •a).
6–7	The influence of heat and moisture production of the people	The room temperature reaches the maximum of 29.0 °C and in July, the temperature is 43 % of the time above 24°C. This is 18 % more than without people. High relative humidity levels with high enough temperature also make mould thrive. Therefore, in summer, cooling and dehumidification are needed.

Indoor climate simulations showed that it is not possible to provide desired indoor climate parameters (temperature >10 °C and relative humidity 40...70 %) in the exhibition rooms only with heating system without using additional mechanical air drying and humidification.

3.2 STRATEGY AND SOLUTION FOR BUILDING SERVICE SYSTEMS

The mechanical HVAC systems was designed due to the requirements of the heritage conservation. The best indoor climate of the exposition halls would have been ensured by a space-based air-conditioning device integrated with heater, humidification and drying, which would have allowed to keep and adjust indoor climate parameters precisely as required in each room. Central Air Handling Unit (AHU) is supplied with recirculation and heat recovery system.

The design of the HVAC system was complicated because the space for horizontal placement of HVAC pipelines was very limited. Placement of pipelines was also restricted because of the fact that openings (breaking existing walls) into existing walls were allowed only in places that did not have special historical value. There were very few such places in the building.

Considering aesthetic suitability of space-based equipment, high cost, very limited possibilities for connecting this equipment to pipelines and that not very precise indoor climate parameters in the exposition rooms were required, a space-based HVAC solution was abandoned and other alternatives were looked for.

It has to be emphasized once more, that not very high value exhibits are kept in the exposition rooms of the building. Demands on indoor climate are considerably milder than common known museum's indoor climate requirements. For the client it is important, that the temperature would not drop below 10 °C and would not rise above 25 °C and that the relative humidity would be 40–70 %. If there are such milder requirements, it is possible to discard expensive space-based climate solutions and ensure indoor climate with central systems.

It was possible to deepen the basement floor by ca 0.5 m, which made it possible to install the main pipeline of the heating system under the floor. The heating of the premises was resolved as floor heating, which ensures air temperature of 10 °C during the cold period in the exposition rooms. The heat source of the building is district heating. There was not enough space for placing the ventilation ducts under the floor and under the arch.

The RH of the exposition rooms is kept by the Central AHU, Figure 2.

In winter, when moisture content of the outdoor air is low, the steam injector located in the AHU humidifies the supply air entering the exposition rooms to the extent that the relative humidity of the premises is guaranteed to be 40 %. During the summer period, when moisture content of the outdoor air is high, supply air is dried in the cooling coil, where the moisture condensates out. After the cooling battery, supply air is passed through a heating coil, in which the relative humidity of the air is reduced. The AHU has an integrated compressor-cooling unit that transfers the heat output of the condenser to the exhaust air in the AHU, so there is no need to install an external part of cooler to spoil the exterior of the building.

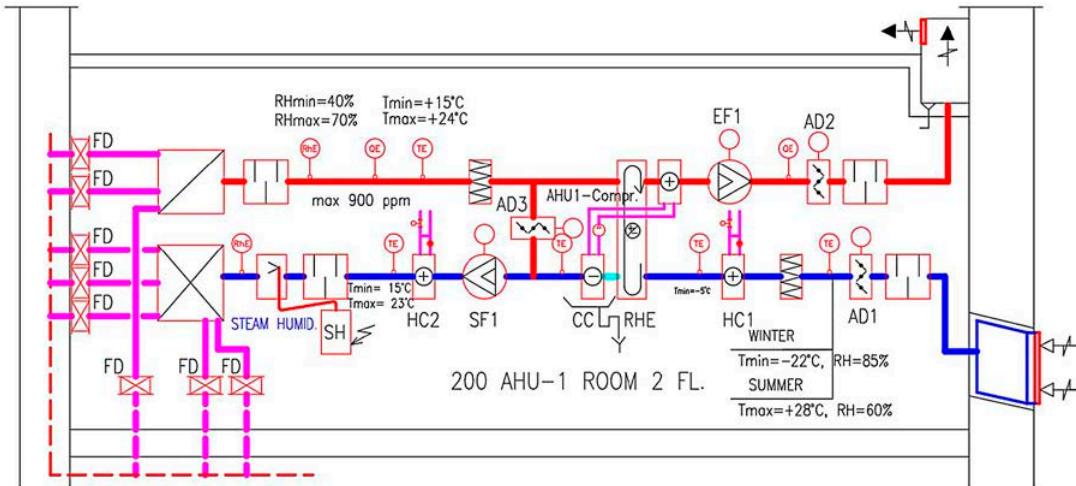

Figure 2. The principle of the Central AHU.

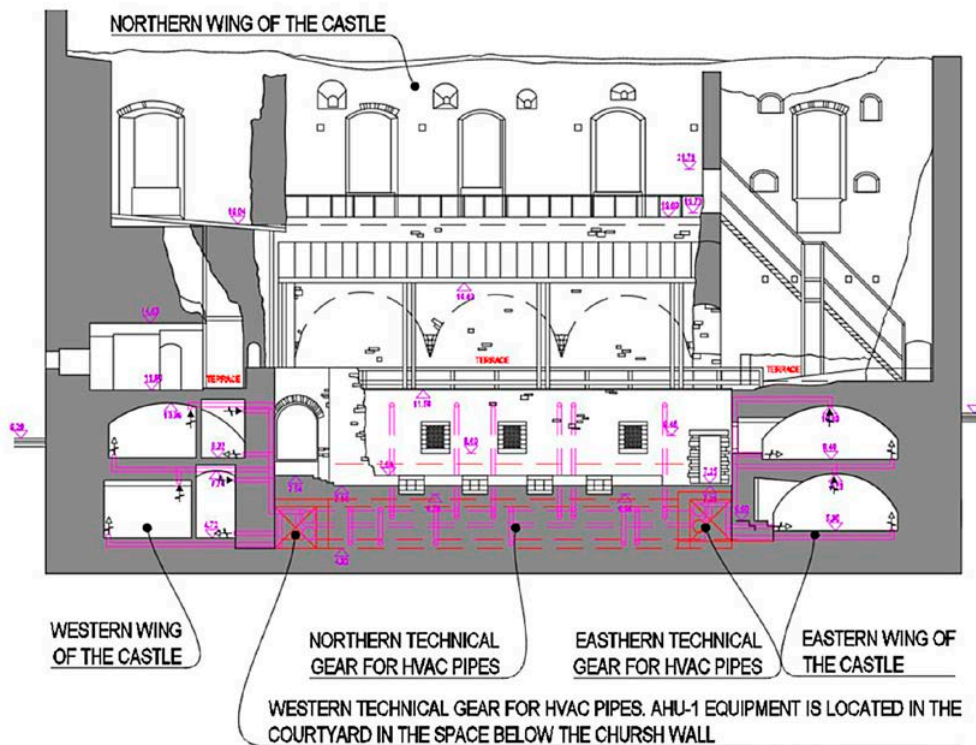

Figure 3. The first option for ventilation ducts.

The cooling unit's compressor integrated in the AHU is an inverter type and the unit operates on the variable refrigeration flow principle, which allows flexible adjusting of the cooling operation.

Another challenge in the design of indoor climate systems was to find a suitable location for horizontal air ducts heading from the ventilation chamber to the exposition rooms. According to the HVAC designer, the hinterland of the fortress would have been the most suitable location for the horizontal air ducts. Air ducts would have been located near the outer wall underneath the ground (see Figure 3). The underground solution would have caused excavation work in the

courtyard, very likely to have exposed objects of archaeological value in the ground. The client did not want to start archaeological excavations in that area, so other options had to be sought for the placement of air ducts – it would have demanded large scale destruction of heritage masonry. Holes for air ducts were possible only in limited places.

Considering other solutions, it was recognized that within the building it is not possible to find suitable location for horizontal air ducts. The roof over the exposition rooms is planned as a terrace for visitors. The external perimeter of the terrace must be encircled with security barriers for the safety of visitors. A solution was found in cooperation with the architect, namely to design

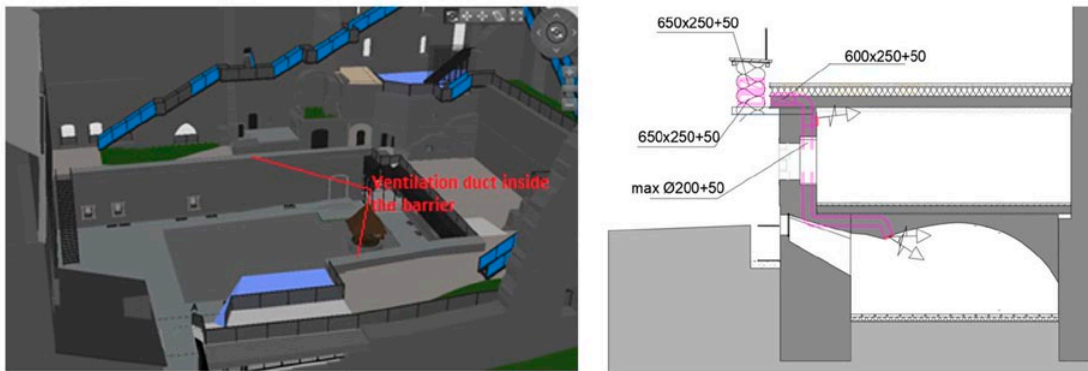

Figure 4. Section of the northern wing (right).

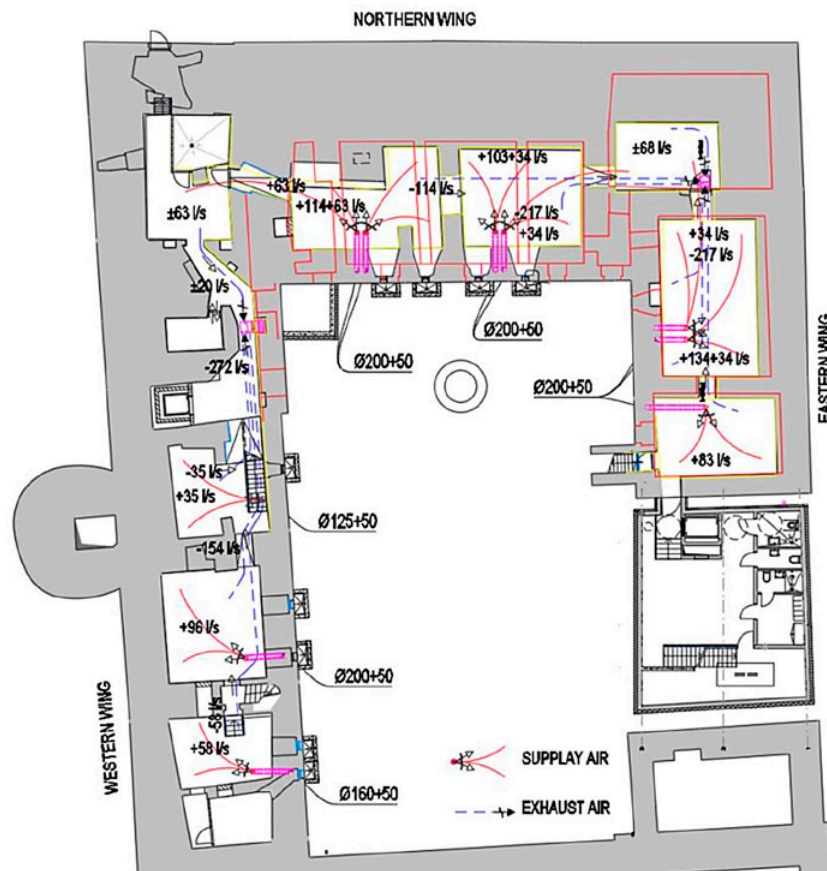

Figure 5. Ventilation ducts and airflow on the ground floor.

horizontal ventilation ducts inside the barrier (Figure 4 left). In order to avoid ventilation air to cool down and condensate, the protection barrier construction was insulated. Metal air ducts installed in the walls headed from the horizontal air ducts located in the barrier to the exposition rooms (Figure 4 right).

The original ventilation solution option provided that each exposition room had both a supply and an exhaust. Such solution would have ensured better indoor climate. Unfortunately, this solution would have required destruction of too many walls of high historical value and therefore the original principle of the air exchange of the premises had to be changed. The final solution provides supply air in every room. The spaces that are connected to each other with the doors will have extract air only from one of these spaces (Figure 5).

In addition to the aforementioned ventilation system, there are two more AHUs in the building, one serving the reception area of visitors and the second serving the cafe area.

4. CONCLUSIONS

The ruins of the medieval Episcopal Castle of Haapsalu in Estonia are taken into use as a museum. Field measurements before design and mould growth on paintings showed the need for improvement of indoor climate. Indoor climate systems were designed for the future museum using energy efficient technologies. The interaction of indoor air and moisture performance of the building envelope was taken into account in a combined heat, air, and moisture simulation model in IDA-ICE software using different indoor climate control strategies and different outdoor climatic conditions. Simulation results showed that it is difficult to provide strict required indoor climate conditions for museums throughout the year only with passive measures, and indoor climate is strongly dependent of the outdoor climate. The final design solution includes room heating, humidification during winter, and dehumidification during summer and autumn to ensure suitable indoor climate.

5. ACKNOWLEDGEMENTS

This research was supported by the Estonian Centre of Excellence in Zero Energy and Resource Efficient Smart Buildings and Districts, ZEBE, grant TK146 funded by the European Regional Development Fund, and by the Estonian Research Council with Institutional research funding grant IUT1-15.

6. REFERENCES

- [1] EN 15757, Conservation of Cultural Property—Specifications for temperature and relative humidity to limit climate-induced mechanical damage in organic hygroscopic materials, Brussels, 2010.
- [2] D. Camuffo, E. Pagan, A. Bernardi, F. Becherini, The impact of heating, lighting and people in re-using historical buildings: a case study, *Journal of Cultural Heritage*. 5 (2004) 409–416. doi:10.1016/j.culher.2004.01.005.
- [3] K. Konsa, I. Tirrul, A. Hermann, Wooden objects in museums: Managing biodeterioration situation, *International Biodeterioration & Biodegradation*. 86 (2014) 165–170. doi:10.1016/j.ibiod.2013.06.023.

- [4] L. Bratasz, R. Kozłowski, L. Lasyk, M. Lukomski, <?>. Bartosz Rachwak, Allowable Microclimatic Variations for Painted Wood: Numerical Modelling and Direct Tracing of the Fatigue Damage, in: ICOM-CC (International Council of Museums–Committee for Conservation) 16th Triennial Conference, 2011: pp. 1–7.
- [5] T. Kalamees, A. Väli, L. Kurik, M. Napp, E. Arumägi, U. Kallavus, The influence of indoor climate control on risk for damages in naturally ventilated historic churches in cold climate, *International Journal of Architectural Heritage*. (2015). doi:10.1080/15583058.2014.1003623.
- [6] M. Ryhl-Svendsen, Indoor air pollution in museums: a review of prediction models and control strategies, *Reviews in Conservation*. 7 (2006) 27–41. doi:http://dx.doi.org/10.1179/sic.2006.51.Supplement-1.27.
- [7] M. Martens, H. Schellen, A sound indoor climate for a museum in a monumental building = Un sano clima interno per un museo in un edificio monumentale, in: *Indoor Environment and Preservation: Climate Control in Museums and Historic Buildings = Ambiente Interno E Conservazione: Il Controllo Del Clima Nei Musei E Negli Edifici Storici*, 2010: pp. 183–189.
- [8] R. Kramer, H. Schellen, J. van Schijndel, Energy Impact of ASHRAE’s Museum Climate Classes: A Simulation Study on Four Museums with Different Quality of Envelopes, *Energy Procedia*. 78 (2015) 1317–1322. doi:10.1016/j.egypro.2015.11.147.
- [9] E. Arumägi, T. Kalamees, K. Öiger, U. Kallavus, L. Kurik, Indoor climate analyzis of the Old Observatory in Tartu, in: 9th International Conference and Exhibition–Healthy Buildings 2009, HB 2009, 2009.
- [10] M. Napp, T. Kalamees, Energy use and indoor climate of conservation heating, dehumidification and adaptive ventilation for the climate control of a medieval church in a cold climate, *Energy and Buildings*. 108 (2015) 61–71. doi:10.1016/j.enbuild.2015.08.013.
- [11] M. Napp, M. Wessberg, T. Kalamees, T. Broström, Adaptive ventilation for climate control in a medieval church in cold climate, *International Journal of Ventilation*. 15 (2016) 1–14. doi:10.1080/14733315.2016.1173289.
- [12] J. Kurnitski, T. Kalamees, J. Palonen, L. Eskola, O. Seppänen, Potential effects of permeable and hygroscopic lightweight structures on thermal comfort and perceived IAQ in a cold climate., *Indoor Air*. 17 (2007) 37–49. doi:10.1111/j.1600-0668.2006.00447.x.
- [13] J. Jokisalo, T. Kalamees, J. Kurnitski, L. Eskola, K. Jokiranta, J. Vinha, A Comparison of Measured and Simulated Air Pressure Conditions of a Detached House in a Cold Climate, *Journal of Building Physics*. 32 (2008) 67–89. doi:10.1177/1744259108091901.
- [14] K. Kuusk, T. Kalamees, nZEB Retrofit of a Concrete Large Panel Apartment Building, *Energy Procedia*. 78 (2015) 985–990. doi:10.1016/j.egypro.2015.11.038.
- [15] M. Napp, T. Kalamees, T. Tark, E. Arumägi, Integrated Design of Museum’s Indoor Climate in Medieval Episcopal Castle of Haapsalu, *Energy Procedia*. 96 (2016) 592–600.

Adaptive ventilation to improve IEQ

The case study of the pilgrimage Chapel of Holy Stairs

M. Lyszczas and K. Kabele

Department of Micro-environmental and Building Services Engineering, Faculty of Civil Engineering, Czech Technical University in Prague, Prague, Czech Republic. E-mail: michala.lyszczas@fsv.cvut.cz; kabele@fsv.cvut.cz

Abstract – The paper presents the problem of unsatisfactory indoor environmental quality in the Chapel of Holy Stairs in the north of Czech Republic, which is represented by high value of air moisture leading to the degradation of historic interior and frescoes. In order to understand the overall hygro-thermal airflow in the chapel, the monitoring of air temperature and relative humidity in the chapel and the cloister was carried out. Monitoring data, which provides a basis for examining the initial condition of the Chapel, allows the calibration of the numerical model, which applies a suitable algorithm for timing of supplying outdoor air. The model works in simplified form on the physical principles and heat balance method.

The main aim of the contribution is presentation the possibilities and limits of natural ventilation, if a suitable algorithm is applied. The analysis highlights the influence on the indoor environmental quality and overall reduction in the amount of air moisture.

Keywords – adaptive ventilation; historical interior; condensation risk; indoor environmental quality; regression-based numerical model

1. INTRODUCTION

Historically valuable interiors require special attention in terms of the indoor environmental quality, especially hygrothermal parameters play a significant role. Relative humidity value and its fluctuation over the time have a fundamental influence on the preservation of the cultural monuments. Other important parameters are air temperature and surface temperature. Unfortunately, in many cases, these parameters lie far beyond the tolerance zone. In the most common cases, these interiors contend with unacceptably high relative humidity level caused by structural problems, as well as moisture-producing occupants.

Historic interiors contain hygroscopic materials whose moisture content is directly dependent on the relative humidity of the surrounding air [2]. Changes in the relative humidity of the ambient air lead to a decrease or increase of moisture content of the materials and can cause irreversible damage to the material [3]. The ideal problem solving could be to install air conditioning systems that can maintain the exact required parameter value. However, this solution is unacceptable in terms of operational cost and often difficult to implement for many objects [4]. In this case, the use of adaptive ventilation is provided. Natural ventilation with correct definition of the algorithm can lead to improvement of the indoor parameters with minimal energy input.

This paper presents a simplified numerical model describing actual behaviour of the object in sufficient detail. The goal of this model is to find a suitable algorithm, able to indicate proper time and regulation of natural ventilation (e.g. window opening). One of the aims of the paper is to verify the hypothesis that the quality of indoor environment can be improved by applying a suitable adaptive ventilation algorithm.

2. CASE STUDY

The Pilgrimage Chapel of the Holy Stairs is part of the important cultural monument called Loreto in Rumburk in the north of the Czech Republic. Since 2014, it has been included as one of the significant places on the “Via Sacra” Pilgrims’ Way [5]. The Chapel was built between 1767 and 1770 and its staircase is surrounded by unique sculptural decorations and historical ceiling frescoes, which underwent complete renovation between 2007 and 2012 [5, 6]. However, shortly after repair work, the fresco painting and artefacts began to show signs of damage. The presumed cause of this damage is the unsatisfactory indoor environmental quality. This is caused by recurring conditions of higher air humidity combined with lower air and surface temperatures, resulting in condensation of water vapour on the ceilings with frescoes. Moreover, during the winter period the air temperature often falls below zero, causing the condensed water vapour to freeze and ice to develop on the surfaces (Figure 1).

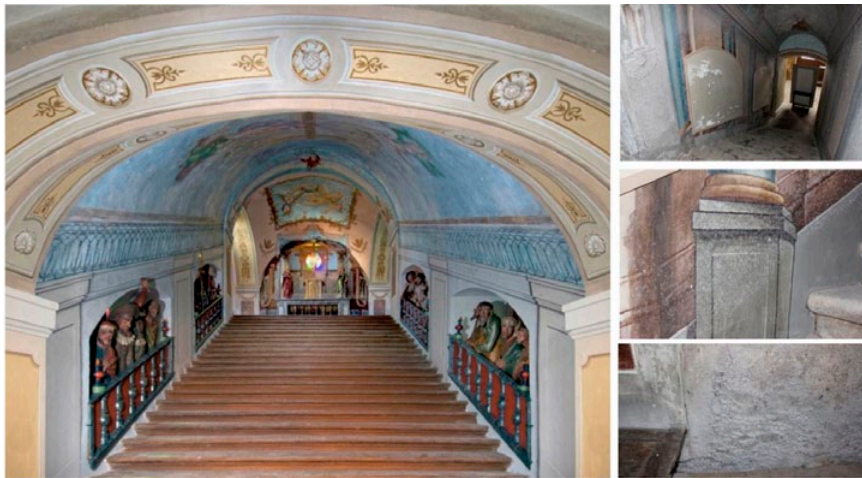

Figure 1. The Pilgrimage Chapel of the Holy Stairs [6], Frost on the frescoes.

The results of the analysis which evaluated the measured data were described [7], and confirm the assumption of moisture ingress from the adjacent corridor. From the previous analysis, it is possible to assume that adaptive ventilation would have a beneficial effect on the reduction of moisture in the chapel.

3. THEORY

The key factor to ensure appropriate internal environment, consists mainly in a moisture balance between hygroscopic material in the interior and ambient air, where the change in the specific humidity of materials reflects on their dimension.

Exposing the interior to air with high relative humidity causes a volume increase of material and, thus, its destruction. On the other hand, constant natural ventilation leads to significant fluctuation in relative humidity, causing damage due to the frequent shrinkage and increased volume of the materials, and increasing of condensation risk on indoor surfaces [8].

Adaptive ventilation takes into account the change in air temperature and level of air moisture in the exterior and interior and, based on the evaluation of the current condition, suggests the supply of fresh air. It can be made functional by a signal for operator, which opens the window [11]. Occasionally, the force from wind and buoyancy is not sufficient for providing enough fresh air. In this case, the use of fan is necessary [12, 13].

Adaptive ventilation cannot replace a full air control system, which is used for accurate environmental management. It only tries to improve the condition from not satisfying to acceptable.

The goals of adaptive ventilation are to:

- move the parameters (air temperature and relative humidity) closer to the required (tolerated) zone;
- avoid an increased risk of condensation associated with the natural ventilation;
- minimize high relative humidity fluctuation associated with the natural ventilation [14].

Parameters of the indoor environment for historical interior are defined in the ASHRAE standard [1], which divides the indoor environment into several categories according to the degree of preservation risk. An acceptable risk is defined by values with $\pm 10\%$ RH and $\pm 5\text{ K}$ deflection from ideal values of 50% RH and $20\text{ }^\circ\text{C}$. Extremely high risk is defined for relative humidity values higher than 75% [1]. At the same time, it is necessary to check the maximum fluctuation during the day, where larger difference than 15% RH throughout the day is considered critical.

Historic buildings are characterized by massive structures with high heat and moisture accumulation capability, which is characterized by frequent condensation. This phenomenon occurs especially during the transition period, when humid exterior air condenses on the still cold surface of the walls.

4. NUMERICAL MODEL

4.1 MODEL METHOD

Different methods can be used to model building behaviour. Most of the software available on the market (eg. DesignBuilder, WUFI, etc.) work on the principle of explicit method, when parameters of object properties are known and behaviour of the object can be calculated. In cases when building behaviour is known and some of input parameters are missing, regression method is used. One of the regression methods describing non-linear function is the neural network method [9].

The task of the regression analysis is to find the appropriate theoretical regression function to describe the dependence, determine the point, interval estimates of regression coefficients, estimation of regression function values for prognostic purposes, and verification of compliance between the proposed regression function and experimental data [9].

In case of examining parameters of hydro-thermal microclimate, dependent variable represent T_i , x_i , T_m as a function (2), (3) and (4).

$$T_i, \tau_{(x)} = T_i, \tau_{(x-1)} + f(m, c, A, U, Te, Tm, h, p, d, Ve, Vi) \quad (2)$$

$$x_i, \tau_{(x)} = x_i, \tau_{(x-1)} + f(c, A, bm, xe, Ti, \Delta p_v, Vi, Ve) \quad (3)$$

$$Tm, \tau_{(x)} = Tm, \tau_{(x-1)} + f(c, A, h, U, Te, Ti, p, d, Vi, Ve) \quad (4)$$

The simplified numerical model created in software MS excel, works on the principle of the regression method.

Calculation of dependent variables T_i and T_m was determined on the principle heat balance method, which is based on the law of energy conservation. This law expresses that heat fluxes always have to be in equilibrium with the total heat energy of the space. Thermal equilibrium is valid at each time step. For this reason, it is possible to say that total energy of space at time $\tau_{(x-1)}$ with the count of all heat fluxes is equal to the total thermal energy of the space at time $\tau_{(x)}$. The heat balance of the space can be written according to formula (5).

$$Q_{total, \tau(x-1)} + Q_{trans} + Q_{inf} + Q_{accu} + Q_{source} + Q_{sol} + Q_{total, \tau(x)} \quad (5)$$

The calculation of dependent variable x_i takes into account the amount of outdoor humidity by ventilation and infiltration, and ability of the material to absorb moisture. Due to the complexity of the issue related to the accumulation of the moisture in the structures, the parameter of moisture accumulation was determined by the regression method from measured data as a function of relative humidity. This assumption was further verified in the software DesignBuilder, which generated identical results with simplified model in MS excel.

Choice of appropriate time step is required for proper model operation. The above described model works with 5-minutes time step that corresponds to the time step obtained from the dataloggers in object monitoring. An additional source of moisture was applied to the model in an amount that corresponds with results from a previous analysis [7].

The model is not able to take into account the possibilities and limits of natural ventilation in terms of buoyancy driven and wind driven ventilation, and is only set to two modes (infiltration: 0,2 ach, or infiltration with natural ventilation 1,5 ach). Determination of air change based on differences in temperature and wind effect is subject to further investigation.

4.2 MODEL CALIBRATION

The model was calibrated based on measured data for a period of 10 days and subsequently verified for other periods with measured data.

The graphs (Figures 2 and 3) show the results of the model verification for the randomly selected period of 10 days. The air temperature results are almost identical to the measured values in all periods that have been verified after calibration. The specific humidity values show acceptable deviations. These differences can be attributed to the considerable simplification of the extensive problems of moisture accumulation in the masonry, and the non-linear influence of the measured values by the additional air humidity coming from the adjacent corridor.

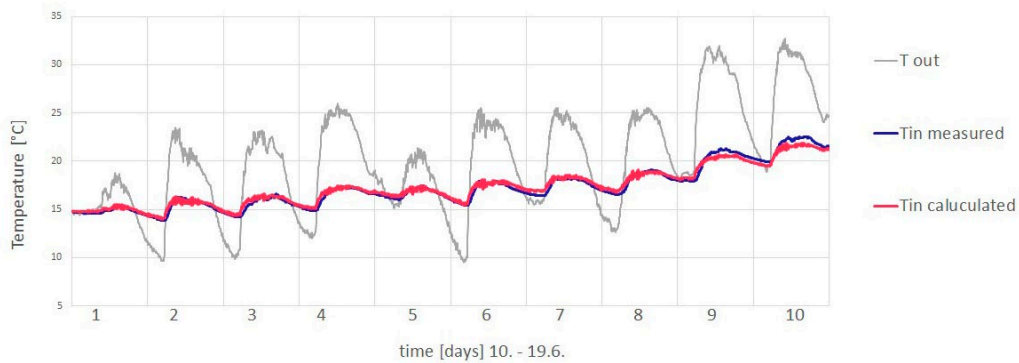

Figure 2. Comparison of measured and calculated air temperature values in the chapel.

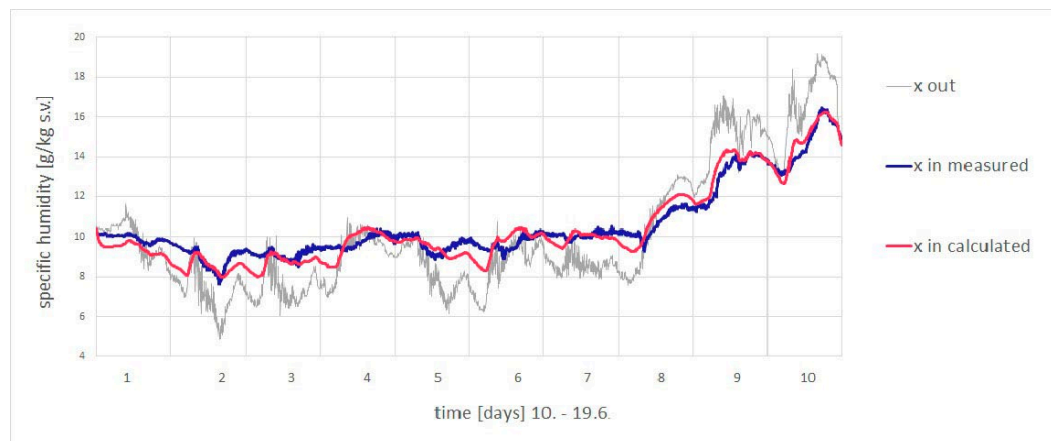

Figure 3. Comparison of measured and calculated specific humidity values in the chapel.

4.3 BOUNDARY CONDITIONS

After verifying the functionality of the model, it was possible to apply the boundary conditions determining the appropriate time for increasing the outdoor air supply. Two conditions mentioned in (5) and (6) were applied in order to move the parameters of air temperature and relative humidity closer to the tolerance zone. The boundary condition (7) avoid undesirable fluctuations of relative humidity in

the interior during the day. The last boundary condition (8) prevents an increase in the risk of condensation on the interior surfaces.

$$T_i < T_e \wedge T_i < 25 \Leftrightarrow \text{„OPEN“} \quad (5)$$

$$x_i < x_e \wedge RH_i < 60 \Leftrightarrow \text{„OPEN“} \quad (6)$$

$$| \max (RH_{\tau,0} - RH_{\tau,30min}) - \min (RH_{\tau,0} - RH_{\tau,30min}) | > 1,5 \Leftrightarrow \text{„CLOSE“} \quad (7)$$

$$T_{dp,ex} > T_m \Leftrightarrow \text{„CLOSE“} \quad (8)$$

In case the model evaluated at least one of the conditions as a “CLOSE” mode, it considers only infiltration.

5. RESULTS

5.1 EVALUATED CRITERIA

The results of the impact of adaptive ventilation to the interior, were evaluated in terms of three criteria: fluctuation of relative humidity, risk of condensation and reduction of air moisture.

The three ventilated modes are presented for assessment:

- Only infiltration: constant 0,2 ach;
- Permanent ventilation: constant 1,5 ach;
- Adaptive ventilation: 0,2 or 1,5 ach (depending on boundary conditions).

5.2 PREVENTION OF HIGH FLUCTUATION DURING THE DAY

Figure 4 represents comparison of relative humidity results. For a better overview of the values, the graph shows only a short period (10 days).

The results with only infiltration mode (blue line) indicate minimal fluctuation, however, these values in just a few cases fall below the critical value of 75 % RH. On the other hand, permanent ventilation results (green line) show extreme daily

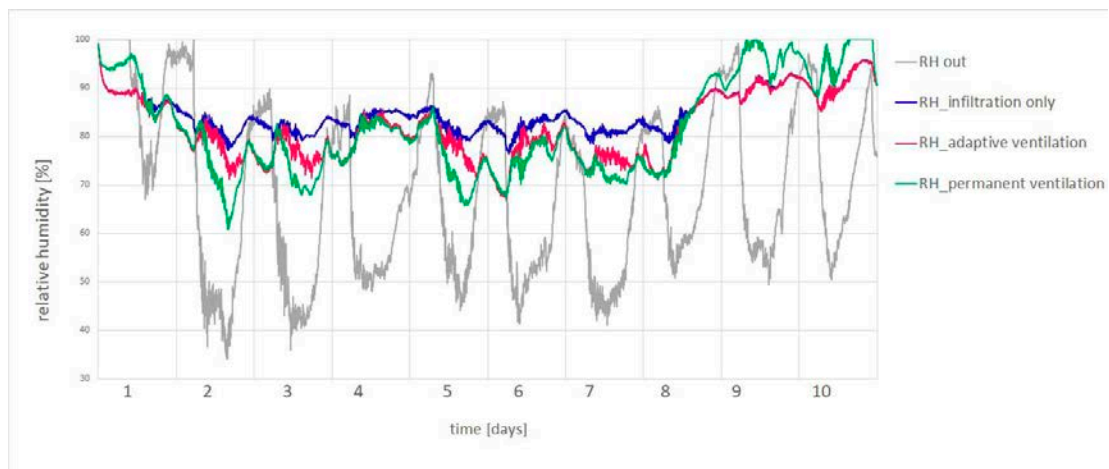

Figure 4. Comparison of relative humidity values for different ventilation mode during the selected period of 10 days.

fluctuations reaching almost 30 % RH. Moreover, in some cases it could also lead to increased values. Adaptive ventilation (red line) represents an acceptable rate of relative humidity decrease, and leads to an overall decrease in relative humidity values.

5.3 PREVENTION OF SURFACE CONDENSATION

The graphs on figure 5 assess the degree of condensation risk during the year for individual modes of ventilation. The red numbers defined percentage of time in which the indoor dew point temperature drops to a lower value than the surface temperature of walls.

The critical periods, in all variants, represent mainly the spring season. In spring, the surface temperature is still low caused by heat accumulation, and warm wet outdoor air together with moisture from the corridor, caused condition for condensation. Due to the lower relative humidity values in the interior, the adaptive ventilation expresses lower condensation risk than infiltration only. As was expected, the highest potential for condensation risk, is represented by constant ventilation.

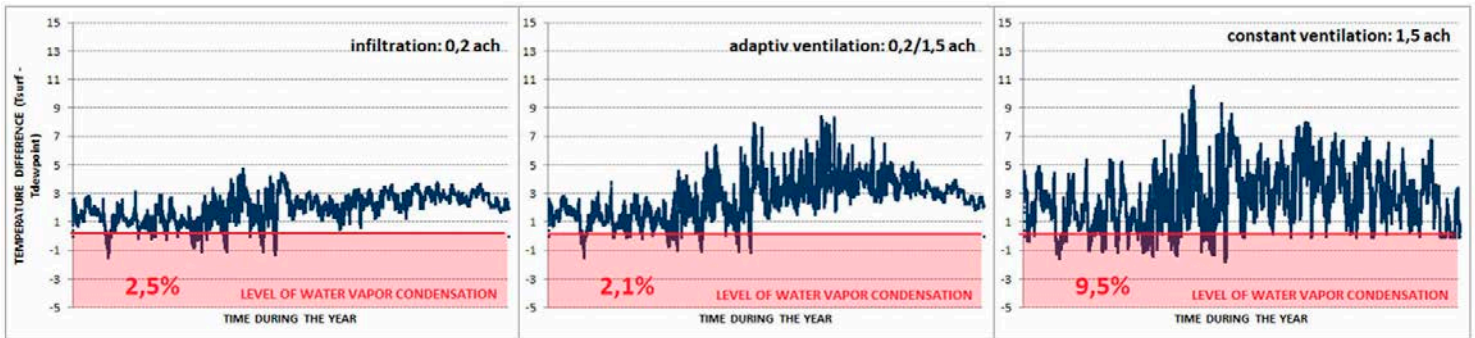

Figure 5. Comparison of condensation risk for different ventilation mode during the year.

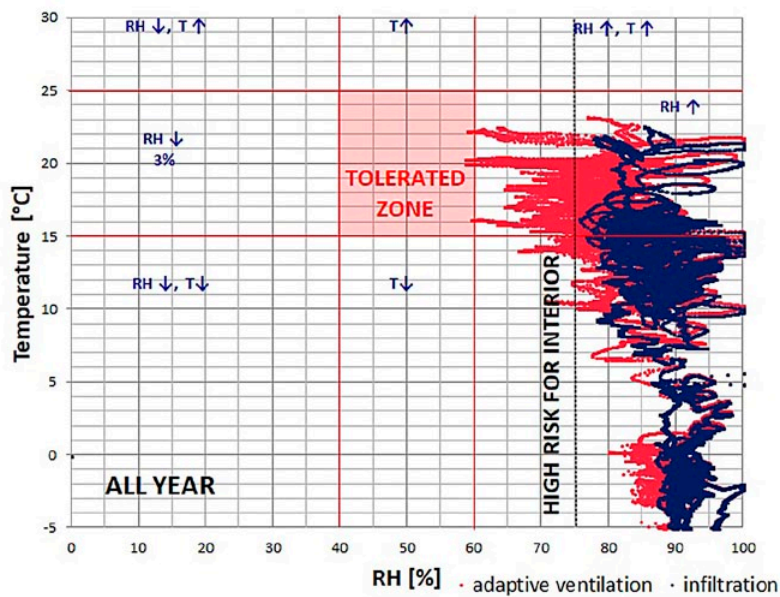

Figure 6. Comparison of calculated air temperature and relative humidity values (blue dots: with infiltration only, red dots: with adaptive ventilation).

5.4 REDUCTION OF RELATIVE HUMIDITY

The adaptive ventilation effect assessment was based on Performance Index (PI) determination, defined as the percentage of time in which the parameters (in this case air temperature and relative humidity) lie within the required (tolerance) parameters [10].

The red dots (representing adaptive ventilation) indicate the moving relative humidity values closer to the tolerance zone. On the other hand, it is possible to observe some time periods where no improvement is observed. Due to very low outdoor air temperature during the winter season, it is not recommended to ventilate to prevent more decreasing of indoor air temperature. In numerical model, this fact is checked by boundary conditions (5).

6. DISCUSSION

The proper timing of natural ventilation is essential, and failure to observe the basic conditions can cause a negative effect for preservation representing high relative humidity fluctuation and condensation on the surfaces. For this reason, the need for more knowledge regarding ventilation of interiors is necessary.

As expected, adaptive ventilation is not able to offer significant change in the quality of the indoor environment. However, the results show the improvement of the indoor air parameters with minimal energy input. It can be assumed that the influence of adaptive ventilation on the quality of the indoor environment will not be similar for buildings with different operations. A positive effect is expected especially in buildings with some added source of moisture, which can be caused by occupants or structural defect. In this case, adaptive ventilation could provide a way to cheaply achieve still acceptable parameters that would not destroy the interior.

Subsequent development of the numerical model will be addressed regarding the issue of natural ventilation limits and value of air change intensity. The presented numerical model considers the use of a simple fan.

7. CONCLUSION

The presented simplified numerical model demonstrates that if a suitable algorithm is chosen, adaptive ventilation can have a positive effect on the quality of the indoor environment. The model was created by regression method using the measured data of air temperature and relative humidity in the interior and exterior. The paper describes the boundary conditions ensuring that the interior will not be damaged due to the sudden change of internal parameters and large amount of outside air. The results of the numerical model confirmed the positive effect of adaptive ventilation on buildings with some additional source of moisture (e.g. occupants or structural defects). At the same time, the assumption of different efficiency in individual periods was verified, proving that in winter the influence on parameters is minimal.

8. REFERENCES

- [1] ASHRAE. "Ashrae application book: Museum, libraries, and archives," pp. chapter 21, 2017.
- [2] P. Zídek, T. Vyhliđal, J. Fiřer, V. Tornari, E. Bernikola, N. Tsigarida. "Diffusion – model – based risk assessment of moisture originated wood deterioration in historic building," *Energy and Environment* 94, pp. 218–230, 2015.
- [3] G. Pavlogeorgatos. "Environmental parameters in museum," *Building and Environment* 38, pp. 1457–1462, 2003.
- [4] M. Filippi. "Remarks on the green retrofitting of historic buildings in Italy," *Energy and Buildings* 95, pp. 15–22, 2015.
- [5] Loreto Chapel. "Loreto Chapel," Available: www.loretarumburk.cz
- [6] Biskupství Litoměřické. "Measurement report of Loreto in Rumburk," Available: <http://www.dltm.cz/ceske-vysoke-uceni-technicke-provadi-vyzkum-v-lorete-v-rumburku>
- [7] M. Balounová, K. Kabele. "Vyhodnocení rizika kondenzace a kvality vnitřního prostředí v poutní kapli Svatých schodů," *IBPSA – CZ Simulace budov a techniky prostředí* 9, 2016.
- [8] J. G. Holmberg. "Environmental control in historical building," *Royal institute of technology building services engineering, Bulletin No. 53*, 2001.
- [9] E. Kindler, I. Křivý. "Simulace a modelování," *University of Ostrava guide-book*, 2001.
- [10] S.P. Corngrati, M. Filippi, M. Perino. "A new approach for the IEQ (Indoor Environmental Quality) assessment, Research in Building Physics and Building Engineering," *Proceeding of 3rd International Conference on Research in Building Physics IBPC 2006, Montreal*.
- [11] V. Sinivee, L. Kurik, T. Kalamees. "A simple adaptive ventilation controller for mediaeval church." *11th Nordic Symposium on Building Physics, NSB2017, Trondheim, Norway. Energy Procedia* 132, pp. 957–962, 2017.
- [12] S. Omrani et. al. "Effect of natural venitlaton mode on thermal comfort and ventilation performance: Full-scale measurement." *Energy and Buildings* 156, pp. 1–16, 2017.
- [13] T. Broström, C.E. Hagentofl, M. Wessberg. "Humidity Control in Historic Buildings through Adaptive Ventilation: a Case Study." *9th Nordic Symposium on Building Physics, Tampere, June 2011*.
- [14] D. Erhardt, F. Antretter, R. Kilian. "Measured and Modeled Influence of the Moisture Buffer Effect in a Historic Stone Church and its Influence on Possible HVAC Measures". *Proceeding of CLIMA 2013–11th REHVA World Congress and the 8th International Conference on Indoor Air Quality, Ventilation and Energy Conservation in Buildings 2013*.

7. LIST OF SYMBOLS

c	specific heat capacity	[J.kg ⁻¹ .K ⁻¹]
T_i	indoor air temperature	[°C]
T_e	outdoor air temperature	[°C]
T_m	temperature of the mass	[°C]
T_{dp}	dew point temperature	[°C]
RH	relative humidity	[%]
ρ	density	[kg.m ⁻³]
A	area	[m ²]
V_i	volume of indoor air	[m ³]
V_e	volume of outdoor air	[m ³]
U	overall heat transfer coefficient	[W.m ⁻² .K ⁻¹]
d	effective thickness	[m]
h	convection heat transfer coefficient	[W.m ⁻² .K ⁻¹]
x_i	indoor specific humidity	[kg.kg ⁻¹]
x_e	outdoor specific humidity	[kg.kg ⁻¹]
τ	time	[s]

Different HVAC systems in historical buildings to meet collection demands

L. Krzemień¹, A. Kupczak¹, B. Pretzel², M. Strojecki¹, J. Radoń³ and E. Bogaczewicz-Biernacka⁴

¹ The Jerzy Haber Institute of Catalysis and Surface Chemistry, Polish Academy of Sciences, Krakow, Poland. Email: nckrzemi@cyf-kr.edu.pl; nckupcza@cyf-kr.edu.pl; ncstroje@cyf-kr.edu.pl

² The Victoria and Albert Museum, London, United Kingdom. Email: boris.pretzel@vam.ac.uk

³ Faculty of Environmental Engineering and Land Surveying, University of Agriculture in Krakow, Krakow, Poland. Email: jradon@kki.pl

⁴ The Radziwiłł Palace in Nieborów and Romantic Park in Arkadia/Division of the National Museum in Warsaw, Poland. Email: ebogaczewicz@mnw.art.pl

Abstract – Energy consumption modelling in historical buildings has been performed to estimate the cost of maintaining the desired indoor microclimate, with the emphasis put on the humidity stabilization for collections care. The chosen buildings represented various types of construction and interactions with the outside conditions. Performance of three methods of humidity stabilization was tested: portable humidifiers and dehumidifiers, a typical HVAC with cooling and heating coils, and an advanced HVAC system with a thermal and enthalpy recovery wheel. The results show that, using a recovery wheels based HVAC system, one can reduce energy consumption from 31 % up to 69 % depending on the building type when compared to portable devices and from 60 % to 85 % in comparison with an inefficient simple HVAC system.

Keywords – HVAC; optimization; microclimate; energy consumption; historical buildings

1. INTRODUCTION

In recent years, there has been growing attention towards reducing energy consumption and attaining sustainable management strategies in buildings. EU guidelines on energy efficiency [1, 2] point to this issue as the key-strategy. However, historic buildings do not have to comply with building energy requirements, since the energy retrofit operations may influence their heritage value. Nevertheless, significant energy savings can be achieved without altering the historic character of the buildings with the use of proper HVAC systems installed in the interiors. Although there is a lot of evidence in the literature showing the potential in taking such actions [3-7], their main focus is to maintain the desired temperature limits, mostly for human comfort.

This paper attempts to extend the analysis of HVAC systems also to the control of relative humidity (RH) levels, which are important from the perspective of protection of heritage collections, since they are very often housed in museums placed in historical buildings. Bellia et al. [8] studied one HVAC system and its variations in a museum building to find a suitable system for the conservation of artworks. In the present work, a step forward is being taken by investigating three

different types of HVAC control systems installed inside a museum gallery space placed in three distinct historical buildings. Attention is paid to both the thermal comfort of the visitors (temperature level limits) and the protection of collections containing hygroscopic materials stored in the museum gallery (RH level limits).

2. METHODOLOGY

2.1 GENERAL REMARKS

This section describes the characteristics of investigated historical buildings, such as construction materials used, operation schedules and assumptions behind the choice of particular spaces for simulations. Secondly, it gives information on the HVAC systems chosen to control indoor microclimate in the selected building spaces. The energy performance of the buildings has been analysed using the EnergyPlus software [9].

2.2 BUILDINGS CHARACTERISTICS

Three historical buildings were chosen to represent various building constructions and interactions with the outside conditions. The Furniture Gallery of the Victoria and Albert Museum in London (the V&A), placed in a 19th century masonry building, is the first museum space analysed (Figure 1a). A glazed roof (skylights) is a characteristic feature of the gallery. Together with operable windows, located along one of the gallery's walls, they provide significant solar gains. However, the internal shades covering the skylights, assumed in the modelling to be closed at all times, reduce the solar radiation. The Temple of Diana, in Nieborów close

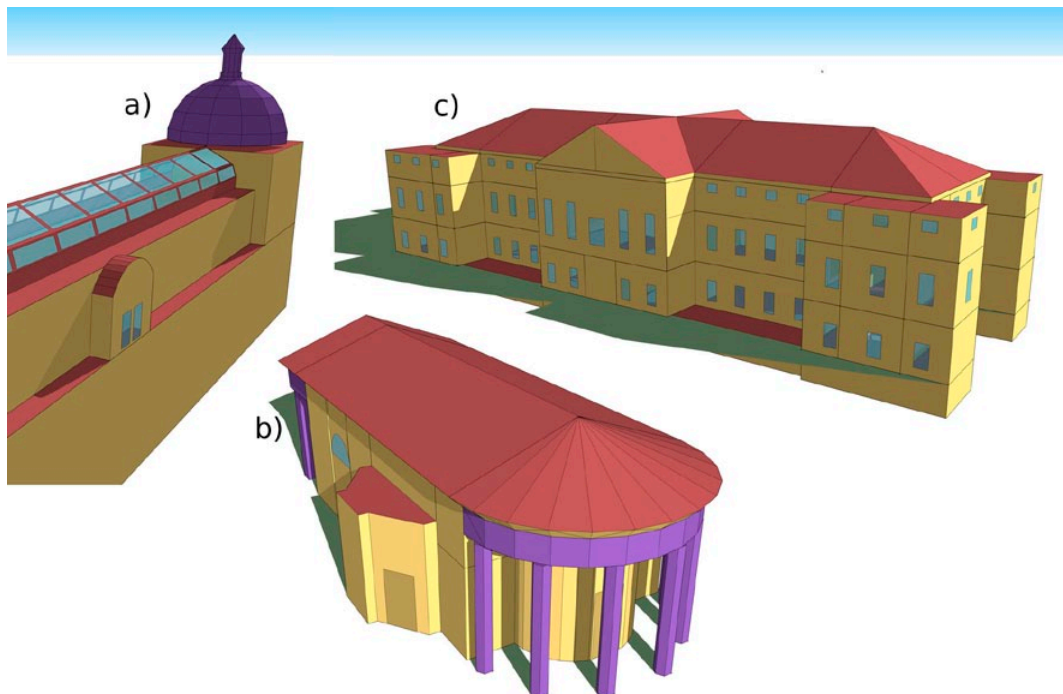

Figure 1. Analysed historical buildings. The Furniture Gallery in the Victoria and Albert Museum (a), the Temple of Diana (b), the Krasieński palace (c).

to Warsaw, Poland an 18th century pavilion in the Greek Revival style (Figure 1b) with solid brick walls and a wooden roof covered with metal panels was the second building analysed. It has almost no windows and is located in a park, which additionally minimizes the solar gains. The third building, the Krasiński Palace, in Warsaw is a typical baroque palace with massive masonry walls and a thermally isolated roof covered with metal sheets (Figure 1c).

As this work was focused on the calculation of energy performance while keeping the indoor temperature and relative humidity (RH) within limits minimizing the risk of damage to cultural heritage objects, a 'gallery space' open to visitors, where furniture collections were stored, was selected in each building. This space type was based on the actual Furniture Gallery located in the V&A and all parameters characterising the use of such gallery space are described in section 2.2. Physical parameters of construction materials that constitute the investigated structures are given in Table 1. One room placed between two towers is the gallery space in the V&A, creating the first zone in the model. The rest of the building, directly connected to the museum gallery, was represented by the cuboid below it, which constituted the second zone in the model. Four rooms on the ground floor formed the gallery space in the Temple of Diana, and four thermal zones in the model. Four smaller rooms constituted the rest of the modelled space, where energy usage was not determined. Since the Krasiński Palace is a very large building with multiple rooms, a small part of it was selected to represent the gallery. It was placed on the ground floor in the north wing and consisted of four rooms.

Table 1. Construction materials (from outside to inside) and features of the simulated museum spaces

Material/ Feature	The V&A	Temple of Diana	Krasiński palace
Interior walls	gypsum plaster (0.013 m), solid brick (1 m)	plaster (0.015 m) solid brick (0.32 m) plaster (0.015m)	cement-lime plaster (0.02 m), solid brick Wienerberger (0.9m), cement-lime plaster (0.02 m)
Exterior walls	gypsum plaster (0.013 m), solid brick (1 m)	plaster (0.08 m) solid brick (0.9 m) plaster (0.015 cm)	cement-lime plaster (0.02 m), solid brick, hand-formed (0.24 m), cement-lime plaster (0.02 m)
Floor	reinforced concrete (0.375 m), woodblock parquet (0.025 m)	stone (0.5 m) airgap wood (0.04 m)	solid brick masonry (0.4 m), concrete (0.05 m), oak (0.03 m)
Ceiling	stone roofing tiles (0.01 m), asphalt roof felt, reinforced concrete (0.15 m), insulation, plasterboard (0.05 m)	wood (0.04 m) plaster (0.015 cm) roof metal panel, wood (0.02 m)	linoleum (0.002 m), softwood (0.02 m), concrete (0.15 m), stucco (0.015 m)
Windows	walls: single glazing skylights: double glazing	single glazing	triple-glazing

2.3 MODELLING ASSUMPTIONS AND STUDIED HVAC SYSTEMS

In the computer simulations, the HVAC systems controlled the indoor microclimate only in the rooms belonging to the museum gallery space where the wooden objects were kept. All other rooms in each building were assumed to be offices, with working hours from 8:00 a.m. to 8:00 p.m. The energy usage in the offices was not determined. As the goal of the microclimate stabilization was to minimize the risk of damage to heritage wooden objects, the climate control scenario for the museum galleries followed the ASHRAE specifications for microclimate quality in museums, libraries and archives [10]. The ASHRAE AA and A class of climate control was chosen, where the relative humidity is allowed to stay within 45–55 % (AA class) and 40–60 % (A class without seasonal adjustments of RH). As wooden objects are of hygroscopic nature, they will interact with the surrounding environment by absorption and desorption of water vapour, affecting in this way the indoor RH. However in the case of museum gallery, based on the previous work [11], the amount of stored objects is not sufficient to visibly influence the indoor microclimate. Although the buffering of moisture by the building including its content was taken into account using simple effective capacitance model [12]. To guarantee thermal comfort for visitors, the heating set point was set to a daily cycle, with 17 °C for night-time and 21 °C during the day. The cooling set point was set at 25 °C.

The analysed museum gallery space type was characterised by the following parameters defining its operation schedules. The human activity started at 7:00 a.m. and ended at 8:00 p.m. The number of people inside the gallery varied and increased gradually reaching its maximum of 0.1 people/m² just before lunchtime. The peak in activity started from 11:00 a.m. and ended at 4:00 p.m. and from this point on decreased gradually to one person at 8:00 p.m. The power released by a single visitor in the form of sensible heat was assumed to be 130 W. All electrical equipment, continuously active, released 1 W/m². Lighting operated from 7:00 a.m. to 8:00 p.m., and 600 lx LED lightbulbs were used, which gave 10 W/m². Each of the analysed HVAC systems was set to maintain one air exchange per hour, a value that was more than sufficient to maintain fresh air for the visitors.

Statistical climatic data for London (the V&A case) and Warsaw (the cases of the Temple of Diana and the Krasiński Palace) were taken as outside weather conditions in the simulations.

In each building, three microclimate control systems (Figure 2 depicts each system) were studied separately to estimate their energy performance. Their characteristics are described in the following paragraphs.

Dehumidification at room temperature involved cooling down air in order to condense the desired amount of water and reheating it afterwards. The main difference between the modelled HVAC systems was the approach to this process. In the system, called 'simple', the air was cooled by a cooling coil powered by a direct expansion chiller and reheated by an electric heating coil. In the system called 'advanced', the same cooling coil was placed between two

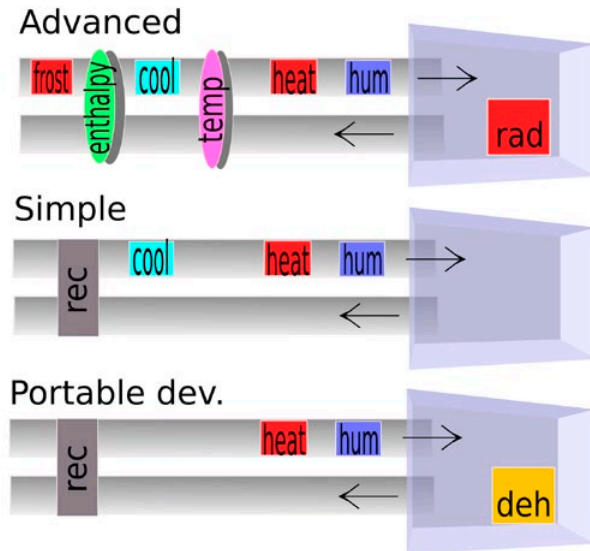

Figure 2. Three HVAC systems installed in the analysed historical buildings: frost – heating coil that preheats air; enthalpy – enthalpy wheel; cool – cooling coil; temp – thermal wheel; heat – heating coil; hum – steam electric humidifier; rad – radiator; deh – dehumidifier; rec – recirculation.

air-to-air heat exchangers. Their role was to aid the cooling and heating coils at no cost. The first one precooled the air entering the cooling coil and transported the heat to the exhaust air. The second heat exchanger reheated the air after the cooling coil, taking energy from the exhaust air. These heat exchangers, apart from aiding the dehumidification process, prevented the conditioned air from being blown out of the building while ventilating. The system called 'portable devices' used standalone dehumidifiers. In this case, thermodynamic transitions that the air underwent during dehumidification were not modelled. Instead, the performance curves, as a function of humidity and temperature, were used.

The approach to the heating and humidification in all the systems was very similar. A steam electric humidifier was used. Cooling and heating were done by the same devices as used for the dehumidification, with the exception of the 'advanced' system, where radiant zone heaters were used to aid heating and 'portable devices' where space was heated by an electric furnace.

3. RESULTS AND DISCUSSION

The annual energy spent on heating, cooling (as a sum of cooling energy for keeping thermal comfort and the dehumidification process) and humidification for three types of HVAC system in the investigated historical buildings is gathered in Table 2.

It can be seen from Table 2 that, for every studied building, the advanced HVAC system with thermal and enthalpy wheels was the most efficient among the tested systems in terms of the total energy consumption. Using this system, the total energy consumption, for ASHRAE AA class of climate control, could be reduced by 30 %, 54 % and 67 % when compared to the portable devices for the Temple of Diana, the V&A and the Krasiński palace, respectively. This reduction increases when the advanced system was compared to the typical HVAC system, spanning from 60 % for the Temple of Diana to 85 % in the Krasiński Palace. Loosening of the microclimate control boundaries from ASHRAE AA to ASHRAE A, reduces

Table 2. Annual energy consumption in kWh/m² for different HVAC systems for ASHRAE AA (ASHRAE A) class of climate control

	Heating	Cooling	Humidification	Total
Victoria and Albert Museum				
Portable devices	220 (225)	7 (3)	43 (26)	269 (254)
Simple HVAC	420 (402)	96 (87)	41 (28)	557 (518)
Advanced HVAC	100 (100)	16 (8)	8 (5)	125 (113)
Temple of Diana				
Portable devices	301 (304)	8 (4)	69 (48)	378 (356)
Simple HVAC	471 (455)	130 (114)	59 (44)	660 (613)
Advanced HVAC	207 (206)	38 (24)	20 (14)	264 (244)
Krasiński Palace				
Portable devices	187 (188)	4 (2)	52 (39)	242 (230)
Simple HVAC	328 (304)	165 (158)	45 (33)	538 (494)
Advanced HVAC	51 (51)	15 (11)	15 (10)	81 (71)

the energy consumption on average by 7 % for Temple of Diana and V&A and by 8 % for the Krasiński Palace. However, additional observations can be drawn by looking at distinct processes. Heating demand for the advanced HVAC compared to other two systems, was low in the V&A and the Krasiński Palace, but increased in the Temple of Diana, due to poor insulation of its walls and the fact that it is a free-standing building with no attached buildings or constructions. Cooling demands showed an interesting feature of the advanced HVAC system. It was less energy efficient than the portable devices. The function of enthalpy

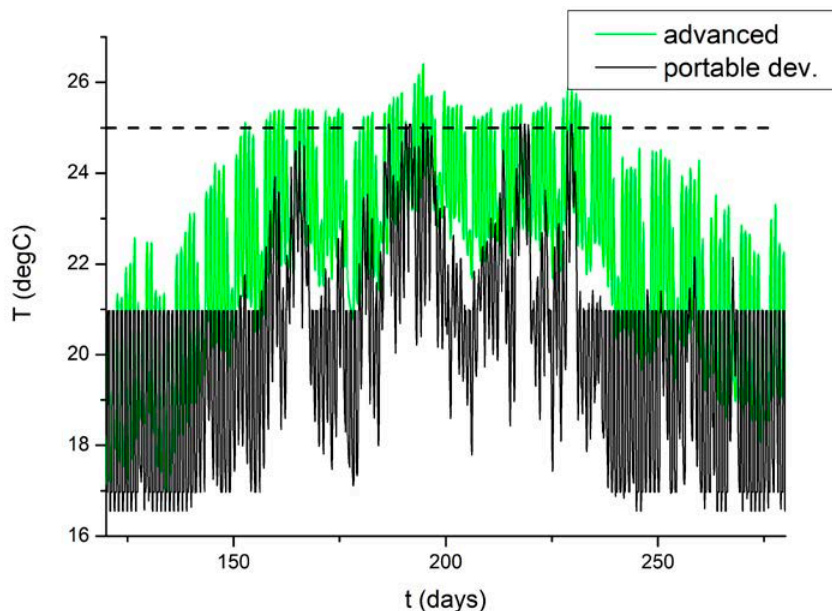

Figure 3. Comparison of temperature variations in the Krasiński Palace induced by two different systems. The advanced system trapped hot air in the zone, therefore, cooling was needed which otherwise would have not been necessary. Dashed line shows the cooling set point.

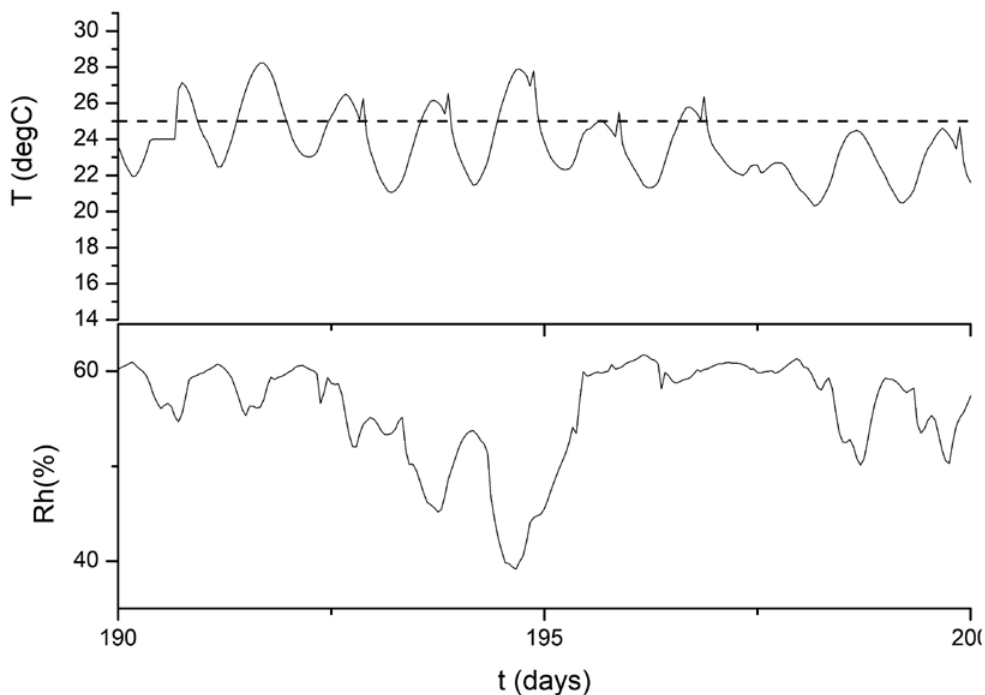

Figure 4. Temperature and humidity in the Temple of Diana during a hot summer period when the advanced HVAC was in operation. RH drops during hot days are shown, because the system was meant for the dehumidification rather than cooling.

and thermal wheels was to keep more heat indoors, so, as a consequence, the temperature rose and if during the night building did not cool down sufficiently, an additional cooling was needed (see Figure 3). Additionally, the portable devices used in calculations were very efficient when it came to dehumidification. It has to be noted however that such effect was strong only for Warsaw weather conditions. It was not so pronounced for London mild weather, without very warm summers.

The advanced HVAC system showed an additional unusual behaviour. It led to severe summer humidity drops during hot weather periods (see Figure 4). The effect was caused by a heat exchanger located after the cooling coil, which reheated the processed air regardless of its condition. In this way, the air was only slightly cooled but very well dehumidified. In hot summer days, when demand for cooling was high, the system just pumped more air which was not so cold but very dry, causing the drops of indoor RH.

4. CONCLUSIONS

The control of indoor microclimate for collection care in museum galleries located in historical buildings requires stabilization of both temperature and relative humidity. Three types of HVAC systems were analysed in three types of buildings in terms of energy needed to maintain the desired limits of these parameters. The system equipped with thermal and enthalpy recovery wheels turned out to be the most energy efficient, consuming less total energy than other two systems.

Additionally, the present study showed two interesting features of this system when used in climates with hot summer. It requires more energy for cooling than it would have in mild climates, since its design keeps the processed warm air indoors. And secondly, during hot days, it may induce significant drops of RH, so the microclimate has to be constantly monitored to avoid long over-dry episodes, which might be dangerous for hygroscopic heritage objects. Another observation can be drawn, that is by relaxing the RH allowable band, greater relative savings can be achieved in the case of more energy effective systems.

5. REFERENCES

- [1] Directive on the energy performance of buildings, EPBD Recast 2010/31/EC.
- [2] Commission Delegated Regulation (EU), No. 244/2012 of 16 January 2012.
- [3] A. Ghahramani, S. A. Karvigh, and B. Becerik-Gerber, "HVAC system energy optimization using an adaptive hybrid metaheuristic". *Energy and Buildings*, vol. 152, pp. 149–161, Oct 2017.
- [4] F. Ascione, N. Bianco, C. De Stasio, G.M. Mauro and G.P. Vanoli, "Building envelope, HVAC systems and RESs for the energy retrofit of a Conference Hall on Naples promenade". *Clean, Efficient and Affordable Energy for a Sustainable Future, Proceedings Paper* vol. 75, pp. 1261–1268, 2015.
- [5] H.E. Silva, F.M.A. Henriques, T.A.S. Henriques and G. Coelho, "A sequential process to assess and optimize the indoor climate in museums". *Building and Environment*, vol. 104, pp. 21–34, Aug 2016.
- [6] A. Kusiak, G.L. Xu and Z.J. Zhang, "Minimization of energy consumption in HVAC systems with data-driven models and an interior-point method". *Energy Conversion and Management*, vol. 85, pp. 146–153, Sep 2014.
- [7] N. Nassif and S. Moujaes, "A cost-effective operating strategy to reduce energy consumption in a HVAC system". *International Journal of Energy Research*, vol. 32, no. 6, pp. 543–558, May 2008.
- [8] L. Bellia, A. Capozzoli, P. Mazzei and F. Minichiello, "A comparison of HVAC systems for artwork conservation". *International Journal of Refrigeration- Revue Internationale Du Froid*, vol. 30, no. 8, pp. 1439–1451, Dec 2007.
- [9] "U.S. Department of Energy. Energy Plus simulation software," Version 8.6.0, 2016.
- [10] ASHRAE Handbook : Heating, Ventilating, and Air-conditioning Applications. Atlanta: ASHRAE 2003, chap. 21 Museums, libraries and archives.
- [11] A. Kupczak, A. Sadlowska-Salega, L. Krzemien, J. Sobczyk, J. Radon and R. Kozłowski, "Impact of paper and wooden collections on humidity stability and energy consumption in museums and libraries," *Energy and Buildings*, vol. 158, pp. 77–85, Jan 2018.
- [12] H. Janssen, S. Roels, "Qualitative and quantitative assessment of interior moisture buffering by enclosures", *Energy and Buildings*, vol. 41, pp. 382–394, Apr 2009.

Status determination and risk assessment of measures in historic buildings

J. Arfvidsson¹, B. Bjelke-Holtermann² and J. Mattsson³

¹ *Building Physics., Lund University, (LTH), Lund, Sweden.*

² *Tyréns AB, Lund, Sweden.*

³ *Mycoteam AS, Norway*

Abstract – Today there is a need for energy-efficiency measures in historic buildings. Clarifying both opportunities and risks for energy-efficiency measures in historic buildings is a challenging task. To ensure that such measures will provide the planned result without damage to the building or poor indoor climate, a skilled holistic approach is required. To be able to propose accurate measures requires a thorough understanding of the individual cultural heritage, the existing building's function and how the measures will affect the building. This requires a multidisciplinary knowledge, for example building antiquarian, building biological and building physical expertise. In this paper, a method for status determination of existing buildings, and a method for risk assessment of energy saving measures, are presented.

Keywords – historic buildings, energy efficiency, moisture safety, status determination.

1. INTRODUCTION

1.1 BACKGROUND

There is currently a major focus on how use and maintenance on one side, and climate and climate change on the other, influence service life of materials in historic buildings. [5,6]. Less known is the problem how other changes significantly can influence the building physics performance and any consequential damage due to this [7,13]. Most of Scandinavia's historic buildings have during various times undergone changes in design and usage. Older structures have been renovated with new construction solutions and materials. Changed requirements for indoor climate and energy use has led to use of new heating and ventilation systems. The results of these changes have not always been satisfactory, and sometimes resulted in different building damages or non-acceptable indoor climate [8,16]. These mistakes have sometimes led to extensive costs in damage remediation. In addition, in many cases, important historic values are lost during the restoration work.

Building a new energy efficient house requires considerable expertise in a number of areas. To implement energy-saving measures in existing buildings often requires even more. Changes into thicker insulation, intermittent heating, new types of building materials and reduced or modified ventilation, affect the thermal and hygroscopic properties of the building. These changes increase the risk for moisture and mould damage [15,11]. Unfortunately, it is usually the case

that the sensitivity and the risk of for example moisture damage have increased because of these measures. A number of structures, which we know is critical to moisture, will become even more sensitive, and new parts of the building, which previously functioned well, will be in the risk zone. We have many examples of this in buildings with crawl space basements or cold attics that were remedied after the energy crisis in the 1970's. When additional insulation is used in the building envelope of poorly insulated buildings, the temperature in the crawl space, attic and parts of the outer wall will be lower than before during the cold period. For example, if warm moist air can be transported from the heated space in the building up of the attic, it cools down and the relative humidity increases. Also, during cold clear winter nights, the inside of the outer roof will sometimes be so cold that the outside air, through ventilation from outside, may condense on the inside of the attic. The inside of the roof becomes damaged, as will the attic floor because of the condensation that forms on the inside of the outer roof, dripping down and causing moisture and mould damage [18]. Basement walls were up to 1994-95 thermally insulated on the inside, normally in combination with a windbreaker against the foundation wall and a damp barrier on the warm side of the insulation. Such construction is a high-risk construction with respect to moisture problems, and in old buildings, where there might be some intrusion of water through the wall, the risk of both mould fungi and decay fungi is extremely high [4]. If we look at the crawl space, it is another time of the year that becomes dangerous regarding moisture. In winter, the crawlspace cools down. When spring and summer arrive, warm and humid outdoor air gets into the crawlspace through ventilation openings. The crawl space is still cold and when hot humid outdoor air enters the crawl space, it cools down and the relative humidity of the air increases. When humid air comes into contact with sufficiently cold surfaces, condensation and free water occurs. This increases both the risk of moisture and mould damage [19] and decay problems [13]. Use of modern building materials, such as gypsum boards and fibreboards instead of traditional wooden materials, also increases the risk of mould damage due to poor mould resistance capacity in modern materials [18,17].

A number of measures to reduce the risk of moisture damage are found in modern constructions. These should however also be adapted to use in historic buildings. Often change in heating system is made, for example from a local system to district heating. A chimney that previously was hot and warmed up the cold attic gets cold. The negative pressure created through the "chimney effect", and contributed to the ventilation, is gone. The result can be a building, which is indeed energy efficient but has a very high risk of moisture and mould, poor ventilation and therefore a bad environment for both the building and humans. A critical side effect in access to moisture problems is also often elevated radon values in these poorly ventilated buildings, especially in basements and the ground floor. Change of windows and more efficient air-tightening reduce the natural ventilation in old buildings. In concrete buildings this can be critical and change from a ventilation rate about 0,5 to less than 0,15 air change/hour, which has been documented after replacement of windows [16].

A methodology to handle renovation and energy update of historic buildings is requested by many actors in the process of updating historic buildings without causing damage and undesirable effect. A method that takes into account various important aspects would reduce the risk of this kind of negative effects during renovation.

1.2 AIM

The goal is to develop a method and to produce different types of tools that are necessary to ensure proper status determination and risk assessment of energy update targets in historical buildings. The method should take into account the various aspects that are believed to affect the results of renovation/energy updates of historic buildings.

1.3 LIMITATIONS

Effects due to actions in connection with the accessibility and fire safety has not been fully taken into account so far. These parts will be developed within the framework of the project.

2. METHOD

Performing a risk assessment of existing and future problems and damage is complicated. No complete method, dealing with this, is used today. To make an accurate risk assessment requires knowledge of a number of factors.

The work to develop a methodology for status determination and risk assessment of energy conservation in historic buildings involves different experts working together. In our case it is limited to building physicists, building biologists and building conservators but also fire safety and accessibility will be considered within the project. Also other relevant disciplines can easily be supplemented if needed.

The goal has been to develop a method that can be used in the same way for the different disciplines, reflecting the different aspects but in the end create a result of consensus for the proposed actions. Different existing working methods and methodologies have been looked at and parts of them have been adopted and put together under a development in time. Through frequent meetings and discussions, with a goal to understand more of each other's specific areas and way of thinking, the method has grown and been developed.

Different versions of the method have been tested in real case scenarios during the process and the experience of the practical use of the method has caused changes and corrections to make the method better and easier to understand and use. Examples, where the method has been used, have earlier been published and can be found in [1] and [2].

At present, the method is ready to be tested by other actors, consultants as well as national boards and agencies, to get their feedback and make the necessary adjustments in order to find a working method for future renovations and energy updates of historic buildings.

3. RESULT

3.1 SUMMARY OF THE DEVELOPED METHOD

The work has resulted in a method to address the building physical, biological, and antiquarian aspects, as well as fire safety and accessibility of a building at present and after certain measures.

Each of the disciplines has been treated in a similar way, which makes it possible to handle them all within the same system. The systematics in the method is inspired from the ByggaF-method [14], which is developed to assess the moisture safety in buildings through out the whole building process.

The Building physics part deals with energy efficiency, moisture safety, ventilation and indoor climate, but also building technology. A number of checklists are developed to cover and assess the different building physical aspects. Example of a checklist is found in Appendix 1.

The Building biological part deals primarily with the presence of different kinds of mould and wood-decaying fungi and insects. However, absence of expected damage is also of special interest. Examples of checklists have been designed to facilitate the possibility to assess the degree of attack and how dangerous it is, but also the reason behind and the way to minimize the future effects [10].

It is important to distinguish between old, inactive and ongoing active attacks of various organisms. One must also be able to assess the occurring organisms and the current building physics that cause the suitable conditions for bio-deterioration. In addition, it is important to distinguish between species that can easily be developed further by even low humidity values, and those that die out if it is not very wet. This knowledge and understanding is in fact the foundation in order to be able to assess the consequences of various energy efficiency measures in the building in question.

The building conservator (conservation consultant) deals with building technology, traditional building materials and heritage values. The care of the historically valuable buildings is governed by certain general principles, special requirements and legislation, based on each building's individual cultural and technical characteristics. Some general guidelines are: preserving the character, using minimally invasive procedures, preventing damage, using traditional materials and traditional techniques. This does not necessarily exclude modern technology as long as it preserves both the character and the life of the house.

The method is divided in different modules:

1. The building (building envelope)
2. The interior (loose and solid)
3. Building services installations
4. Climate (outdoor, indoor)
5. Current laws and regulations (informative part)

The information is built up by the different experts from "bottom to top". All details are dealt with and successively put together in bigger and bigger units and

modules that are either approved or not. In Figure 1 a schematic picture of the process is showed.

When the status determination is made, it is much easier to see what has to be done and what is the most urgent to take care of. Different measures, and how they may influence other parts in the system, have to be assessed. A kind of risk assessment has to be made, at this stage we use different mould models.

All together the result of the method gives an overview of the present status of the building and also the possibilities for different measures. It forms a more holistic base for decision makers to be able to decide what to do and at what risk.

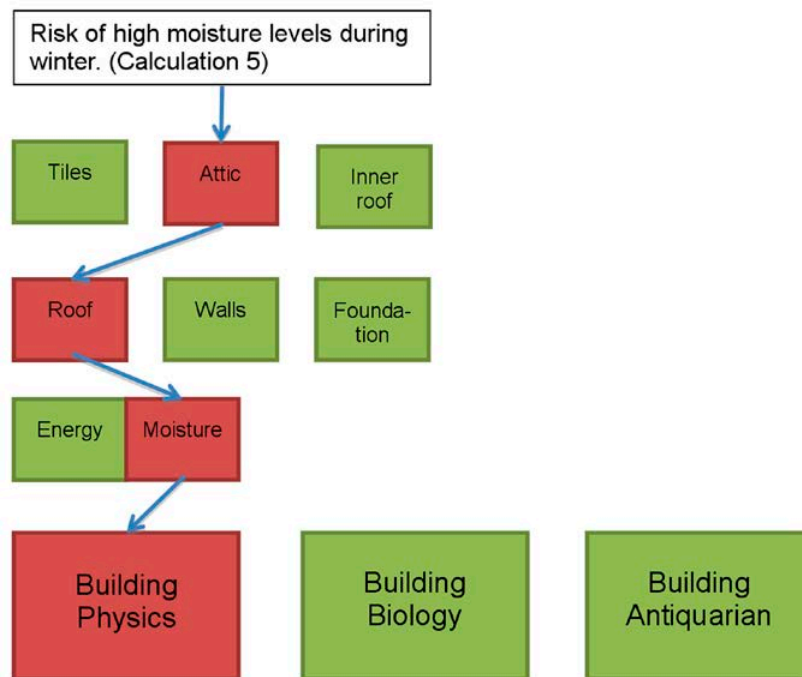

Figure 1. The “bottom to top” process. All details are successively put together in bigger and bigger units. The objective is to give an, easy to understand, overview as a base for decision makers.

The method can also be used the other way around, “top to bottom”, see Figure 2. If a module is not approved, it is possible to step down in the hierarchy and in detail find the reason why a special part has failed to pass. The reason could be found in any of the main three different parts; building physical, building biological or building antiquarian aspects.

One challenge in the Building Antiquarian aspects is to find levels and adequate information and guidelines within the method in order to identify and preserve cultural and historical values. As a user of the method, one must also be aware of, and accept, that conservation aspects will not always lead to optimal improvements and vice versa. Another challenge was to make the whole method user-friendly.

For historic buildings and those of traditional construction, an appropriate balance needs to be achieved between building conservation and measures to

improve energy efficiency if lasting damage is to be avoided both to the building's character and significance and its fabric. [9].

An understanding of what constitutes the special interest or significance of a historic building requires experience. Very often technical, philosophical and aesthetic conflicts will need to be resolved and on occasion highly creative solutions to problems will be necessary. In such circumstances there is no substitute for the knowledge, skill and judgment of qualified and experienced professional advisors, such as architects or surveyors experienced in historic buildings. Such experts have both the technical ability and wide working knowledge of historic buildings, essential to properly informed maintenance and adaptation. Their advice can thus prevent damage and unnecessary expense and heartache [10].

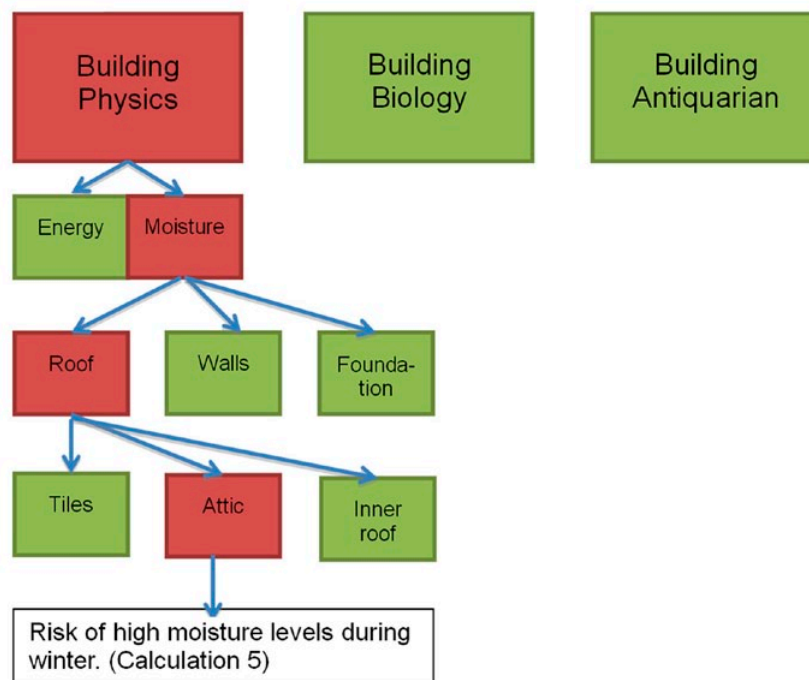

Figure 2. The overview of the status of the building is shown with coloured boxes. For more detailed information it is possible to get more and more information about the background to different problems or damage.

3.2 PRACTICAL WORK USING THE METHOD

The typical procedure for carrying out a status determination and risk assessment of actions in a historic building, is divided into the following working parts:

3.2.1 Preparations

This part clarifies which laws and regulations apply to the particular object. Drawing documents are provided as well as any documentation of previous actions. If possible, interviews are conducted with persons who know the history of the objects.

3.2.2 In situ inspection

In this part, different experts work parallel to each other and collect information important for their specific expertise. Photo documentation and checklists are used to ensure that all parts and aspects of the object is considered and checked. Necessary measurements are made and samples are taken. Larger measurements or samples are suggested. The checklists are made in a way that makes it possible to get necessary help, partly through concrete proposals, but also through examples from already completed status determinations.

3.2.3 Status determination

The different experts discuss and explain their results to each other. A joint document is created that describes the status of the object. This document is the most important and most comprehensive in the method, and will provide the basis for future assessment and decisions regarding any changes and renovations of the object.

3.2.4 Proposed actions

With a well-conducted status determination, it is easier to assess which actions must be done and which are possible to be implemented. Sometimes immediate action is required to prevent further damage; sometimes it is an assessment where one must take into consideration the future desirable use of the object.

It is common for different experts to have different views/opinions about what kind of actions need be taken in an object. Everyone monitors their respective special areas. In order to find out which measures are best suited, measures in which all areas are taken into account, require the different experts to explain how they have thought and prioritized. The aim of this is that in consensus find out what measures are possible to take within the framework of the different scenarios of the object.

3.2.5 Documentation

All steps presented above are documented in a transparent way to give experts, as well as decision makers, as much information as desired.

4. DISCUSSION

In order to propose measures in an existing building, it is important to know the status of the building at present. One must get a clear picture of how the existing building works building physically today (and maybe even how it was intended to work from the beginning), considering heat-, air- and moisture transfer in materials and structures, and what influence various changes might have.

The condition of the materials and structures must be determined with respect to moisture exposure, mould, wood decaying fungi and wood-destroying insects. This is important both for the potential need for repair or replacement, and also for evaluation of the risk for a possible further development of the occurring damage, such as in cases with dry rot.

Due to the fact that damage, caused by bio-deterioration in old buildings, are the result of an accumulated damage development through the buildings' service life, it is important to clarify when and why the damage has occurred, and what the yearly development has been [11]. Such knowledge of damage does often give a detailed understanding in both what the general risk for bio-deterioration in the actual building is, and the consequences of a possible further development.

Lack of expected attack also provides important information that must be considered and analysed.

5. CONCLUSION

Energy efficiency measures in old buildings are a challenging task. By using a multi-disciplinary approach, it is possible to interpret how the building has functioned so far and what consequences various changes in use and construction may have. This provides an opportunity to optimize measures regarding energy efficiency while maintaining cultural heritage values and reduce risk of occurrence of fungal and insect damage, and a poor indoor-air climate.

5. REFERENCES

- [1] Arfvidsson, J., Bjelke-Holtermann, B., Mattsson, J., 2017. Status determination of a historical building including measures for three different scenarios. 11th Nordic Symposium on building Physics, (NSB 2017), Trondheim, Norway. *Energy Procedia* 132 (2017) 939–944.
- [2] Arfvidsson, J., Bjelke-Holtermann, B., Mattsson, J., 2015. Status determination of a historical buildings, an example. 1st International Symposium on Building pathology, ISBP 2015, Porto Portugal.
- [3] English Heritage. 2012.
- [4] Gobakken, L., Mattsson, J. and Alfredsen, G., 2014. The importance of critical in-situ conditions for in-service performance of wood. *Agarica*, 34, pp. 29-36.
- [5] Grøntoft, T., 2008. Effekten av klima og klimaendringer på den bygde kulturarven.
- [6] Online at: http://www.klimakommune.no/kulturarv/Effekter_av_klima_og_klimaendringer_p_den_bygde_kulturarven_Nedbrytningsmekanismer_og_s_rbarhet.shtml
- [7] Haugen, A., Mattsson, J. 2011. Preparations for climate change's influences on cultural heritage. *International Journal of Climate Change Strategies and Management*, vol. 3 no 4. 2011, 386-401.
- [8] Mattsson, J., 1995. Råte- og insektskader. Tilstandsanalyse og utbedringstiltak. FOK programmets skriftserie nr 23. Norges Forskningsråd.
- [9] Mattsson, J. 2000. Inspection and evaluation of decay in log structures. In S.J. Kelly et al, eds. *Wood structures: A global forum on the treatment, conservation and repair of Cultural heritage*, ASTM STP 1351. West Conshohocken, PA: American Society for Testing and Materials, pp. 79–94.
- [10] Mattsson, J. 2004. Muggsopp i bygninger. Oslo, Mycoteam.
- [11] Mattsson, J. 2010. Råtesopp i bygninger. Oslo, Mycoteam.

- [12] Mattsson, J., Austigard, M.S. 2014. Introduksjon til bygningsmykologi. *Agarica* 34, pp. 3–10.
- [13] Mjörnell, K., Arvidsson, J., and Sikander, E., 2012: A method for including moisture safety in the building process. *Indoor and build Environment* 21(4), pp. 583–594.
- [14] Mundt-Petersen, 2015, *Moisture Safety in Wood Frame Buildings*, Repprt TVBH-1021, Lund 2015, Building Physcs, Lund University, Sweden, ISBN 978-91-88722-57-7.
- [15] Mycoteam, 2013. Internal Research Report. Unpublished. Oslo.
- [16] Nore, K., Mattsson, J., Austigard, M.S. 2014. Cross Laminated Timber vs. timber frame walls in water damage – comparing drying and mould growth. In *Full Papers – NSB 2014*. Lund: Nordic Symposium on Building Physics 2014, pp. 1261–1268.
- [17] Nunez, M., Hammer, H. 2014. Microbial Specialists in below-grade foundation walls in Scandinavia. *Indoor Air*, pp. 1–9.
- [18] Viitanen, H., 1995. Models of the critical time of humidity and temperature conditions for the development of mould fungi in pine and spruce sapwood. IRG/WP 95 – 20066. International Research Group of Wood Protection. Stockholm. Proceedings ISBN: 978-91-88722-53-9 (TVBH-3061) pp. 1149–1155.

Appendix 1 – Example of a checklist

3.1 Outer wall	Building antiquarian aspects		Building Physics Aspects		Building Biological Aspects		Result All Aspects
	Comment	OK	Comment	OK	Comment	OK	
Type of wall construction							
Material in wall							
Critical moisture levels							
Thermal insulation							
Drying of rain penetration							
Frost safety							
Air gaps (ventilated?)							
Cracks							
Water-dissipating plates							
Eaves							
Multilevel seal							
Joints							
Connections							
Grommets							
Drip plate							
Colour System							
Socket height							
Connection socket wall							
Pressure Picture							
Air tightness							
Vapour barrier							
Moisture Insulation							
Thermography							
Paint discoloration							
Other observations							

Preservation strategy and optimization of the microclimate management system for the Chapel of the Holy Trinity in Lublin

A. Sadłowska-Sałęga¹, J. Sobczyk², J. M. del Hoyo-Meléndez², K. Waś¹ and J. Radoń¹

¹ Faculty of Environmental Engineering and Land Surveying, University of Agriculture in Krakow, al. A. Mickiewicza 24–28, 30-059 Krakow, Poland. Email: agnieszka.sadlowska@urk.edu.pl, krzysztof.was@ur.krakow.pl, jradon@ur.krakow.pl

² Laboratory of Analysis and Non-Destructive Investigation of Heritage Objects (LANBOZ), National Museum in Krakow, al. 3 Maja 1, 30-062 Krakow, Poland. Email: jsobczyk@mnk.pl, jdelhoyo@mnk.pl

Abstract – The Chapel of the Holy Trinity in Lublin is one of UNESCO’s World Heritage Sites in Poland. Its interior houses unique frescoes depicting the coexistence of two medieval cultures in Europe, namely the Greek East and the Latin West. Maintaining an optimal microclimate in the chapel is possible through the use of an extended HVAC system, which includes humidification, dehumidification, and underfloor heating. Temperature and relative humidity of indoor air were constantly measured for five years. The inner wall surface temperature was also measured for two years. The results do not indicate moisture or biological threat for the frescoes. Nevertheless, maintenance costs, in terms of energy, are very high. This paper presents the results of the analysis of alternative scenarios for microclimate control, which would potentially reduce energy use, but will not compromise the preservation of the frescoes. The simulations were carried out using WUFI®Plus and WUFIBio software. The calculations were partly validated by long-term measurement results.

Keywords – preservation strategy, preventive conservation, simulation of energy consumption, microclimate control, medieval architecture and art

1. INTRODUCTION

The Chapel of the Holy Trinity (Figure 1) is a Gothic building, which is a part of the castle complex in Lublin, founded in 1418 by King Władysław Jagiełło. The castle, with its medieval polychromy, is a world-class monument in terms of the state of preservation, richness in iconographic representation, and artistic value.

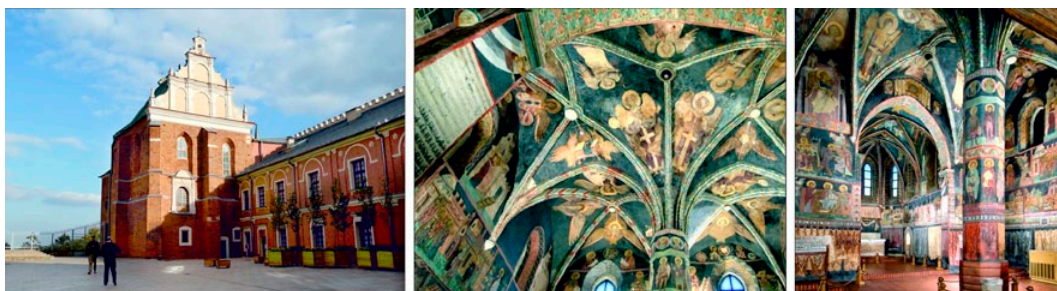

Figure 1. Lublin Castle and Chapel of the Holy Trinity interior. Photos: Lublin Museum.

The Chapel is a place where two cultural circles: East and West, came together and have co-existed up to these days.

The building is a two-story centrally-planned pillar type castle chapel, common in Medieval Latin Europe. There are nine unprotected windows in the Chapel: five windows in the presbytery in the eastern part and four windows in the main aisle in the western part. The Chapel is illuminated with eight halogen lamps. At present, church services are celebrated sporadically.

The Chapel is part of the Lublin Museum. It is open seven days a week, except during the period from October to March, when sightseeing is possible from Tuesday to Sunday. The Chapel cannot be visited by more than 30 people at the same time and the duration of each visit is half an hour. In addition, there is a 30-minute break between groups. Preserving the optimal microclimate in the chapel is supported by an extended HVAC system that takes into account heating, cooling, humidification, and dehumidification [1]. The Lublin Museum carried out monitoring and registration of microclimate parameters, temperature (T) and relative humidity (RH), in the chapel for a number of years. The surface temperature of the walls was also measured for two years.

The analysis of available long-term measurement results does not indicate moisture or biological threats. Nevertheless, the development of a preservation strategy for this monument, together with optimizing the microclimate management system, including alternative scenarios, are important for the reduction of maintenance costs. Reducing the use of energy in addition to economic advantages, has also ecological and ethical implications. The protection of cultural heritage and simultaneous preservation of the natural environment leads to the implementation of the "green museum" concept. Various scenarios of microclimate control, usage patterns, and potential climatic changes were analyzed within the framework of this research. The basic tools used to reach these objectives were simulations of microclimate by means of WUFI®Plus – a specialized software for modelling microclimate and energy consumption in buildings. In addition, risk of mould growth was determined by WUFIBio software.

2. PROTECTION STRATEGY

The assessment of physical hazards, related to microclimate variability, is based on standards adopted by the Lublin Museum. Acceptable microclimate parameters were defined based on risk assessment methods for mould growth developed at the National Museum in Krakow according to the model proposed by Klaus Sedlbauer [2] and literature data on the rate of chemical degradation of frescoes. The range for T and RH established by the Museum are 18–22 °C and 45–55 %, respectively.

The assumed parameters are maintained with the help of an air handling unit (AHU) located in a nearby room. The base cooling or heating power is 22 kW. An additional 24.5 kW unit is available if the power demand is higher, or in case of failure of the base unit. The AHU is capable of providing up to 8 kg water vapor

per hour within humidification demand. The heating system is supplemented by 15 kW electric underfloor heating.

The microclimatic data was provided by the Chief Conservator of the Castle for a period of five years. The data were collected from November 2011 to June 2016, with one-hour time intervals. Figure 2a shows the measured T and RH patterns including allowed ranges defined by the Museum. As can be seen in the Figure, the air conditioning system was not able to maintain the ranges defined by the Museum. For example, RH in heating seasons was lower from the designed range, which indicates an improper humidification process.

To assess the quality of real microclimate, analysis of data was performed in accordance with the EN 15757: 2011 standard [3] (Figure 2b). The upper and lower limits of the target relative humidity fluctuation ranges are determined respectively on the 7th and 93rd percentile of fluctuations recorded during the control period. According to this standard, no indications on climate-induced damage were identified. Additionally, the mycological risk index attack (growing of fungal spores) was calculated from the measured data of air parameters. It was found that the current microclimate in the Chapel does not favour this type of threat. Also, thermographic measurements did not reveal humid areas, which would constitute local sources of mycological activity.

Based on the measurement analysis, visual assessment, ad hoc measurements, and interviews with employees, general recommendations regarding microclimate maintenance were reconsidered. The authors have recommended relaxing the preservation target by increasing these ranges to 15–25 °C and 35–65 % for T and RH , respectively. It should be noted that heating of the interior of the Chapel during winter time is dictated by the comfort of staff and visitors. This would also maintain a large margin of safety against all types of physical, chemical, and biological threats. The proposed value ranges were adopted for simulations using alternative scenarios.

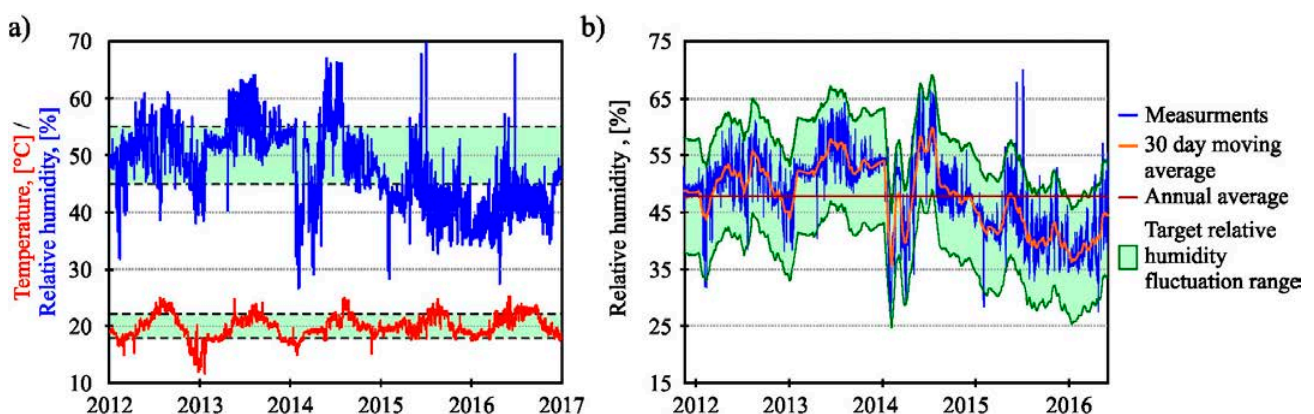

Figure 2. Temperature and relative humidity variation in the Chapel in 2012–2016 (a). Determination of the permissible range of changes in relative humidity (b).

3. SIMULATION OF MICROCLIMATE AND ENERGY CONSUMPTION BY DIFFERENT CONTROL SCENARIOS

3.1 CALCULATION TOOLS

Calculations of microclimate and hygrothermal partition performance in the Chapel were made using the WUFI®plus software. The tool, developed by the Fraunhofer Institute for Building Physics, allows realistic calculations of transient coupled one- and two-dimensional heat and moisture transport in walls and other multi-layer building components exposed to natural weather. The software has been widely validated through many years of experimental research including historical buildings [4, 5]. The risk of mould growth was estimated using the WUFI®Bio software. This tool includes a biohygrothermal model based on the comparison of measured or calculated transient boundary conditions with growth conditions for typical mould found on building materials [2, 6, 7].

3.2 MODEL OF THE BUILDING

Three-dimensional modelling of the Holy Trinity Chapel in Lublin began with a detailed review of inventory drawings and photographic documentation of the building. Based on these documents, digital versions of the building were made in Sketchup and WUFI®plus (Figure 3). The building has many architectural elements and details, which have been simplified due to their geometrical complexity. The key task was to reflect the wall and window areas, cubature, and orientation towards the cardinal points. The massive brick walls of the Chapel do not have a homogeneous structure. They consist of two layers of solid brick (external and internal) and the empty space between, filled with brick rubble. The thickness of particular layers was estimated based on technical documentation. The vault thickness varies depending on the spot in the vault cross-section. In the model, the thickness of the vaults was averaged for the entire cross-section.

For the purpose of the analysis, 72 variants of calculations were developed. These are constituted by a combination of five alternatives of microclimate control based on Lublin Museum and Protection Strategy guidelines (lack of any control, only heating: setpoint 15 °C or 18 °C, full control: temperature 18–22 °C or 15–25 °C, *RH* in the range 45–55 % or 35–65 %); four variants of the presence of visitors (lack of visitors as well as groups of 30, 45 and 50 people – including and excluding breaks between individual groups); six variants of external climate

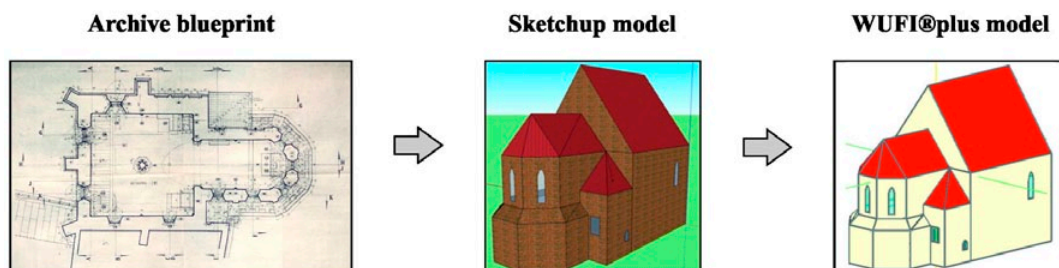

Figure 3. Scheme showing the creation of a building model in WUFI®plus starting from a blueprint.

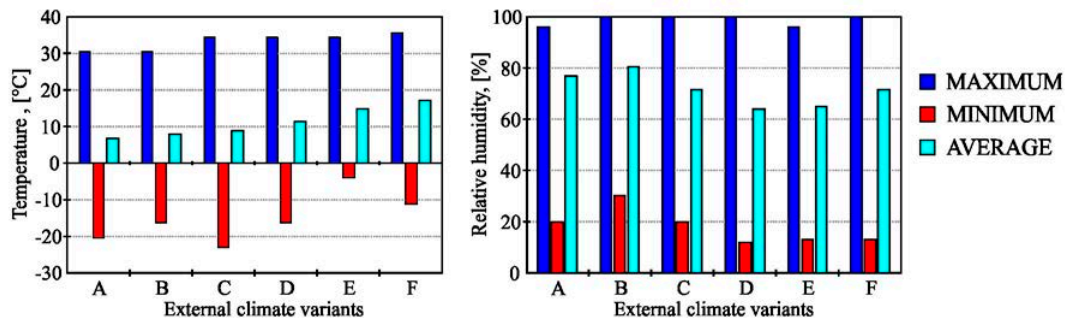

Figure 4. Extremes and mean value of temperature and relative humidity for external climate variants.

characterized by different values of temperatures and relative humidity (variant B in Figure 4) corresponds to the statistical climate for Warsaw, which is similar to the statistical climate for Lublin).

The climate data were taken from the WUFI®Plus database, which contains a vast number of statistical climates as well as properties of historical building materials, heat and moisture gains from people depending on their metabolic activity, etc.

Simulations were performed for one calendar year with a 30-minute time step. In order to eliminate the so-called initial condition error, a three-month preliminary calculation was performed.

Due to the lack of accurate climate data on the external air (temperature, relative humidity and solar radiation intensity) and the operation parameters of the air-conditioning unit, it was impossible to fully validate the model. The plausibility of calculations was determined based on the average difference between the wall surface temperature measured in the period from July 2016 to July 2017 and the simulation results, which amounted to 0.9 K (with a strong positive correlation – correlation coefficient of 0.774).

3.3 PARAMETERS OF THE INDOOR CLIMATE

As a result of the simulation, the patterns of temperature and relative humidity of the air, for all variants inside the Chapel were obtained. In the absence of microclimate control, air temperature drops below 0 °C, as can be seen in Figure 5. According to statistical climate for Lublin, temperatures lower than 0 °C cover 12 % of year. The period in which the temperature is in the range of 18–22 °C covers 19.4 %. In the summer, the temperature slightly exceeded the desired maximum temperature (exceedances accounted to 0.3 %). Relative humidity, on the other hand, stays permanently above the required range. Its minimum value was 63.1 % (average – 85.6 %). To keep the temperature in the desired range, it is enough to introduce heating. However, in the case of relative humidity, full microclimate control is necessary (regardless of the external climate variant).

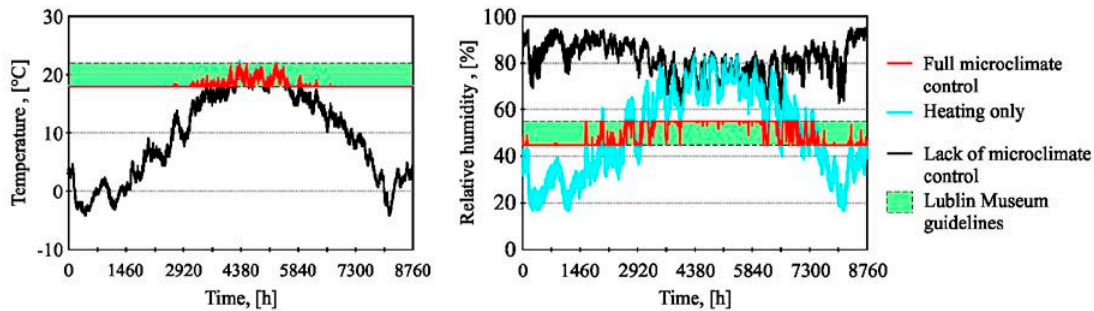

Figure 5. Annual variability of temperature and relative humidity of the indoor air for various microclimate control variants (statistical climate for Lublin, touring groups of 30 people, 30-minute breaks between groups; requirements of the Lublin Museum); in the temperature graph, the blue line is almost indistinguishable as it is overlapped with the red one.

3.4 RISK OF MOISTURE CONDENSATION ON THE INNER SURFACE OF THE WALL

In the absence of microclimate control with simultaneous presence of visitors, there are episodes in which the wall surface temperature was lower than the internal air dew point temperature. The annual share of hours in which condensation occurs is small. The maximum of 1.03 % was observed in the case of the statistical climate for Lublin, for the variant in which the break between groups was not taken into account. The risk of condensation appears in the winter months (December to March). The introduction of breaks resulted in reducing the risk of condensation to 0.13 % per year.

In all variants, which included active systems, condensation risk did not occur. In the case of no humidity control, the minimum difference between temperature of the surface of the partitions and the dew point temperature of air was 1.2 K. With full microclimate control, the minimum difference increases (for all external climate variants) to 8.5 K and 5.6 K for the guidelines of Lublin Museum and Protection Strategy, respectively.

3.5 RISK OF MOULD GROWTH

The Viitanen model, implemented to the WUFI@Bio, uses a six-level “mould index” describing the mould-infested fraction of a surface [8]. As a result of the calculations, index values for individual partition layers were determined. Similarly, as in the case of the risk of moisture condensation, the risk of mould growth was noted only for the variant in which the microclimate control system was not taken into account and in the presence of visitors. The value of mould index in this case reached the maximum of 0.9 (index 0 corresponds to no growth, and index 1 corresponds to some growth visible under the microscope). In this case, mould growth is 50–200 mm per year. Additional criteria or investigations are thus needed in order to assess acceptability.

3.6 CO₂ CONCENTRATION

It was assumed that the air exchange rate in the Chapel (ACH) is 0.5 h⁻¹. Taking into account the groups of 30 visitors and the lack of breaks between groups, CO₂ concentration can reach 1438 ppm (Figure. 6). In order to reach the acceptable

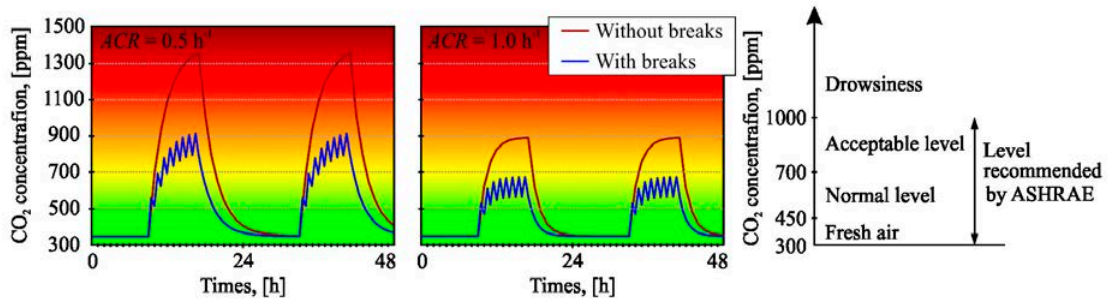

Figure 6. CO_2 concentration with exchange rates of 0.5 h^{-1} and 1.0 h^{-1} for groups of 30 visitors, with and without breaks.

level indicated by ASHRAE equal to 1000 ppm, the air exchange rate should increase to 1.0 h^{-1} . To go below 700 ppm, the air change rate should be greater than 1.7 h^{-1} . After introducing 30 minute breaks between groups, the CO_2 concentration did not exceed 1000 ppm (max. 960 ppm).

3.7 ENERGY CONSUMPTION

The energy potentially consumed for heating and cooling was obtained from the calculation in WUFI@plus. The energy for humidification and dehumidification was derived from modelling in terms of kilogrammes of water that need to be taken or added to the air. The heat of evaporation of water at $100 \text{ }^\circ\text{C}$ – $2500 \text{ kJ}\cdot\text{kg}^{-1}$ – was used to calculate the energy consumption in the humidification process. The energy needed to remove 1 kg of water vapour was estimated at $1.9 \text{ kWh}\cdot\text{kg}^{-1}$ [9].

In the case of statistical climate, as shown in Figure 7a, heating is the most energy-consuming process. The narrowing of the required range of air temperature and relative humidity from the proposed alternative scenario ($T = 15\text{--}25 \text{ }^\circ\text{C}$, $RH = 35\text{--}65 \%$) to preliminary Museum Lublin assumptions ($T = 18\text{--}22 \text{ }^\circ\text{C}$, $RH = 45\text{--}55 \%$) results in an increase of energy consumption. For the statistical climate of Lublin, a 43 % increase in costs can be expected. In the case of warmer summers and milder winters, increases in costs can be significantly higher (Figure 7b).

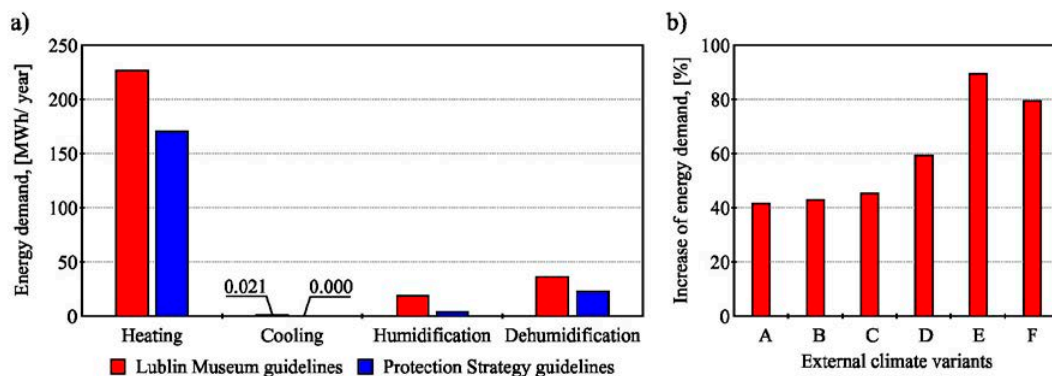

Figure 7. Energy demand for all HVAC processes for groups of 30 visitors, including breaks (a). Increase of energy demand in case of loosening microclimate requirements (b).

The analysis of power demand for heating, cooling, humidification, and dehumidification shows that the existing HVAC system is capable to maintain both climate scenarios simulated under statistical climate. In case of relaxed inner climate parameters, it has about a 10 % power excess for heating/humidification and a 40 % excess for cooling/dehumidification accordingly.

4. SUMMARY AND CONCLUSIONS

In situ measurements and computer simulations indicate that currently there is neither risk of moisture condensation on the internal surface of the partitions nor mildew growth in the Chapel of the Holy Trinity in Lublin. However, the climate control scenario, preliminary applied by the Museum could not be maintained by the extended HVAC system.

The analysis of measured real climate parameters according to the EN 15757: 2011 standard did not indicate any climate-induced threat. Based on this results, as well as on other assessments, a new relaxed climate control scenario was proposed. The new scenario allows to reduce maintenance costs without compromising the preservation of frescoes.

The theoretical calculations of energy demand were carried out with the assumption of two variants of acceptable ranges of temperature and relative humidity fluctuations: preliminary conditions required but not kept by existing HVAC and conditions proposed in the Protection Strategy (coinciding with the measurement results). The narrowing of proposed new requirements to the preliminary scenario may result in an increase of energy demand by 40 to 90 % depending on external climate. Since the calculations were carried out assuming statistical climate, the real savings could not be determined.

The duration of breaks between groups of visitors has a significant impact on fresh air demand, and thus the energy use for ventilation. No break will require an increase of ACH from 0.5 to 1.0 h⁻¹ to keep the CO₂ concentration below 1000 ppm.

The existing HVAC system has sufficient power capacity to maintain the proposed environmental conditions. The system will be readjusted to the new scenario and then regularly inspected.

5. ACKNOWLEDGMENTS

The authors would like to thank the Polish National Center for Cultural Heritage Research (KCBD) for providing financial support to this project. Special thanks to Izabella Jarosławska, from the Lublin Museum for the support during the measurement campaign and for providing the microclimate data from the Chapel.

6. REFERENCES

- [1] Energy Efficient HVAC Systems [in:] *Energy and Buildings*, Edited by Husam Jouhara, Junjing Yang, Volume 150, 2017, ISSN 0378-7788.
- [2] K. Sedlbauer, "Prediction of mould fungus formation on the surface of and inside building components". Dissertation, Universität Stuttgart, 2001.

- [3] PN-EN 15757: 2011 Conservation of cultural property. Specifications for temperature and relative humidity to limit climate-induced mechanical damage in organic hygroscopic materials.
- [4] A. Sadłowska-Sałęga, "Możliwości i ograniczenia obliczeniowego wyznaczenia ciepłno-wilgotnościowych parametrów powietrza w budynkach historycznych (Possibilities and limitations of computational designation of the temperature and humidity in historical)", Dissertation, Cracow University of Technology, 2014.
- [5] F. Antretter, F. Sauer, T. Schöpfer i A. Holm, "Validation of a hygrothermal whole building simulation software," Sydney, 14–16 November 2011.
- [6] M. Krus, M. Seidler i K. Sedlbauer, "Comparative evaluation of the predictions of two established mould growth models," ASHRAE Transactions, Volume 116, Part 2, 2010.
- [7] K. Sedlbauer, M. Krus i K. Breuer, "Mould Growth Prediction with a New Bio-hygrothermal Method and its Application in Practice, Materials Conference," Łódź, 2003.
- [8] H. Viitanen i A. Ritschkoff, Mould growth in pine and spruce sapwood in relation to air humidity and temperature, Uppsala: Swedish University of Agricultural Sciences, Department of Forest Products, 1991.
- [9] A. Kupczak, A. Sadłowska-Sałęga, L. Krzemień, J. Sobczyk, J. Radoń, R. Kozłowski, "Impact of paper and wooden collections on humidity stability and energy consumption in museums and libraries," Energy and Buildings, Volume 158, 2018, pp. 77–85.

Effect of intervention strategies on seasonal thermal comfort conditions in a historic mosque in the Mediterranean climate

K.S.M. Bughrara¹, Z. Durmuş Arsan² and G. Gökçen Akkurt³

¹ Energy Engineering Programme, Izmir Institute of Technology, (IYTE), Gülbahçe, Urla, Izmir, 35430, Turkey. Email: khaledbughrara@gmail.com

² Department of Architecture, Izmir Institute of Technology, (IYTE), Gülbahçe, Urla, Izmir, 35430, Turkey. Email: zeynepdurmus@iyte.edu.tr

³ Department of Energy Systems Engineering, Izmir Institute of Technology, (IYTE), Gülbahçe, Urla, Izmir, 35430, Turkey. Email: guldengokcen@iyte.edu.tr

Abstract – Periodic occupation of the mosque five prayer times per day throughout the year brings about the question: how can we improve prayers' thermal comfort while preserving the heritage value? This paper investigates seasonal thermal comfort variations of a historic mosque in Mediterranean climate based on adaptive thermal comfort model by assessing different intervention strategies with specific attention on cultural heritage value. Salepçioğlu Mosque, located in Izmir-Turkey was monitored for thermal comfort parameters for one year. Calibrated dynamic model of the Mosque was created. Simulation results indicated that the mosque does not satisfy comfort levels for winter, while autumn is the most comfortable season. The utilization of an underfloor heating system is the most effective strategy in increasing seasonal comfort conditions by 55 percent in winter, while the night-time ventilation supports up to 6.1 percent in summer.

Keywords – historic mosque; adaptive thermal comfort; dynamic simulation model, intervention; Mediterranean climate

1. INTRODUCTION

Historic buildings are inherently able to provide acceptable levels of thermal comfort for their occupants. The building itself may achieve a tolerable performance of indoor environment through overall form, orientation, landscape, materials and thermal mass, external openings and natural ventilation. In addition, occupants' behavioural habits such as opening and closing windows, or clothing choices are the variables for optimum human comfort.

Because of their cubic-like volume with a large-spanned dome, intermittent operation schedule and high thermal mass of building envelope, historic mosques have the intrinsic character of developing a microclimate. They function as the public place of worship for Muslims. Unlike other types of public buildings, historic mosques originally have no mechanical heating/cooling system, and for centuries the indoor climate of these buildings has been mainly determined by the outdoor climate. The periodic occupation based on five prayer times per day throughout the year brings about the question: How can we improve prayers' thermal comfort while preserving the heritage value?

Adaptive thermal comfort model defined in ASHRAE 55 can be used as a powerful tool to provide a full picture of occupants' thermal comfort conditions in buildings without HVAC system and with natural ventilation [1–2]. It has an advantage over the conventional thermal comfort standard of the Fanger method [3]: a wider range of thermal comfort can be achieved by providing occupants with the ability of indoor climate control by operable windows and adjusting clothes as well as by psyching up to overheating or cooling [4–6].

A great number of studies have been conducted on possible intervention strategies for public buildings such as dwellings, offices and schools to improve occupants' thermal comfort while a small number dealt with mosques. A mosque in Malaysia, for instance, was evaluated in terms of its insufficient thermal comfort conditions in hot and humid climate [7] and a scenario, by addition of new materials including thermal barrier to the roof, was assessed by a dynamic simulation software. Al-Homoud *et al.* [8] examined the quality of thermal comfort and energy efficiency of several mosques in Saudi Arabia. The authors proposed the addition of thermal insulation to the envelope and the use of an air-conditioning system with intermittent operation as possible intervention strategies to enhance the comfort conditions with less energy consumption.

Salepçioğlu Mosque, built in 1906 in Izmir-Turkey, is registered as a monumental building which is protected by Directorate General of Foundations of Turkish Prime Ministry. This mosque differs from other well-known mosque typologies with its main prayer area located on the first floor. This worship space is covered with a single 12.5 m diameter dome that is characterized by its unique engravings and paintings. The ground floor houses a smaller worship space and classrooms. Women's prayer area is just over the portico (*Revak*), and is directly connected with men's worship space (Figure 1).

The latest restoration work was held in the main prayer area in 2012. The work was focused mainly on the deterioration of wall paintings caused by humidity and waterproofing problems arising from leakages in the roof and windows. Izmir #1 Council for Conservation of Cultural Property (ICCCP)-Ministry of Culture and Tourism, the responsible official body for approval of restoration projects in the city centre of Izmir, restricts the type and qualification of any intervention which will influence indoor thermal balance and create possible risks on wall paintings.



Figure 1. Salepçioğlu Mosque (a) outer view, (b) dome paintings and engraving. Photos: (a) <http://www.umart.com.tr/en/project-details.aspx?p=41&k=1>, (b) Zeynep Durmuş Arsan.

Izmir is located in Mediterranean climate (a.k.a Csa type climate zone under the Köppen Geiger climate classification) [9]. The Mediterranean climate has four seasons: hot and dry summers, mild to cool, and rainy winters, spring and autumn.

This paper presents the seasonal thermal comfort variations of Salepçioğlu Mosque, which has no mechanical HVAC system, based on adaptive thermal comfort model presented in ASHRAE 55 [2]. A measurement campaign was conducted to determine the existing thermal comfort condition of the mosque, then simulation tools were used for the evaluation of the impact of multiple intervention strategies on the existing thermal comfort level. The compatibility and applicability of the intervention strategies were agreed with the local council.

2. METHODOLOGY

2.1 MONITORING

An extensive measurement campaign was performed to determine seasonal thermal comfort variations in the mosque, recording indoor and outdoor temperature (T) and relative humidity (RH) data over a one-year period from October 2014 to October 2015. While three Onset Hobo U12 mini data-loggers were situated in the main prayer area at different heights (M1 at 1.5 m; M2 at 3 m; M3 at 5 m) and positions, one data-logger was installed on the outer surface of the mosque (O) to generate a local weather file for the modelling (Figure 2).

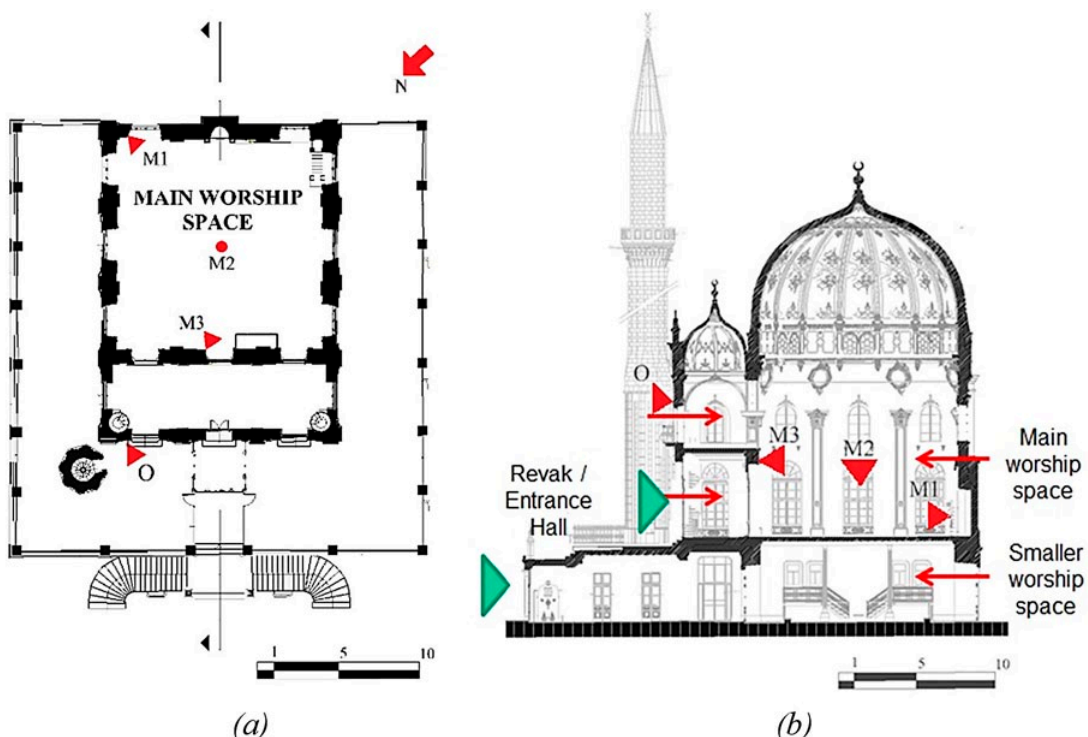

Figure 2. (a) First floor plan of the mosque and location of measurement points in horizontal plane (M1, M2, M3, O), (b) cross-section of the mosque and location of measurement points in vertical plane (M1, M2, M3, O). Source: Modified from the drawings provided by ENVAR Architecture and Engineering Inc.

2.2 MODELING, CALIBRATION AND SIMULATION

The mosque was modelled (baseline model) by DesignBuilder v.4.2 and EnergyPlus v.8.1 [10–11] and then calibrated with measured temperature data.

The calibration process is defined by ASHRAE Guideline 14 [12] which proposes the calculation of two statistical error indices; Mean Bias Error (MBE) and Coefficient of Variation of the Root Mean Squared Error CV(RMSE) with several iterations until the model reaches acceptable level of error ratios. Considering the availability of measurement cycle, the calibration with hourly data approach is done by using (1) for MBE and (2) for CV(RMSE).

$$MBE(\%) = (100 / T_{ma}) \times \left[\sum (T_s - T_m) \right] / N$$

$$CV(RMSE)(\%) = (100 / T_{ma}) \times \left[1 / N \times \left(\sum (T_s - T_m)^2 \right) \right]^{1/2}$$

where:

- N is the number of observations;
- T_{ma} is the average measured temperature for N observations;
- T_s is the simulated hourly temperature;
- T_m is the measured hourly temperature.

The upper limit for CV(RMSE) and MBE values were defined in ASHRAE Guideline 14 [12] as 30 % and ± 10 % for hourly measurements, respectively. The upper limits were used to decide whether the model is calibrated, or not.

The calibrated model was used to simulate the existing thermal comfort condition and to exhibit the effect of intervention strategies on existing thermal comfort condition. All the data needed for the software were obtained from the actual measurements, detailed site surveys, and authors' personal observations.

The structure of the mosque consists of stone masonry. Construction materials were defined by X-ray fluorescence (XRF) and X-ray powder diffraction (XRD) tests. Overall heat transfer coefficients of the materials were calculated based on the material information indicated in the architectural drawings.

2.3 INTERVENTION STRATEGIES

Simulation results on the baseline model showed that improvement of thermal comfort conditions in the mosque is essential. Therefore, four different intervention strategies were proposed to ICCCP, three of which have been approved. These are change of window panes, addition of Khorasan mortar to the roof, and utilization of night-time ventilation. Although rejected by ICCCP, the fourth proposed intervention, application of an underfloor heating system to the main prayer area, was still included in this study to demonstrate the performance of an active heating system. The proposed intervention strategies are summarised below:

- 1) To replace all single window panes with 6–12-6 mm double-glazed ones (low-e) which have a solar heat gain coefficient (SHGC) of 0.43 and an overall heat transfer coefficient (U) of 1.6 W/m²K. U value of single pane windows is 5.77 W/m²K;

- 2) To add a 2.5 cm Khorasan mortar layer under the copper layer of the dome to decrease the U value from 1.096 to 1.042 W/m²K);
- 3) To leave all upper level windows open from 20:00 to 06:00 every day to benefit from lower outdoor temperatures at night-time during spring, summer and autumn seasons;
- 4) To lay out a low-temperature underfloor heating system under the carpet, which consists of electrical resistance wire embedded into a foldable mat. The 15 kW heating system is operated during autumn, winter and spring seasons every day from 10:00 to 22:00. Heating set point temperature is 22 °C.

3. RESULTS AND DISCUSSION

3.1 MONITORING

Indoor and outdoor T and RH values were recorded during the monitoring campaign for one year (October 2014 to October 2015) covering four seasons (Figure 3). Outdoor and indoor T and RH values showed the same trend since the mosque has no HVAC system. Outdoor T values ranged from -2.4 °C to 38.3 °C with the yearly average of 19.7 °C, while indoor T values of the main prayer area varied between 4.9 °C and 35.9 °C with a yearly mean of 21.5 °C. Outdoor RH data vary from 12 % to 99.2 % with the yearly average of 60.5 %, while RH values for the main prayer area ranges between 18.9 % and 83.0 % with a 56.1 % yearly average.

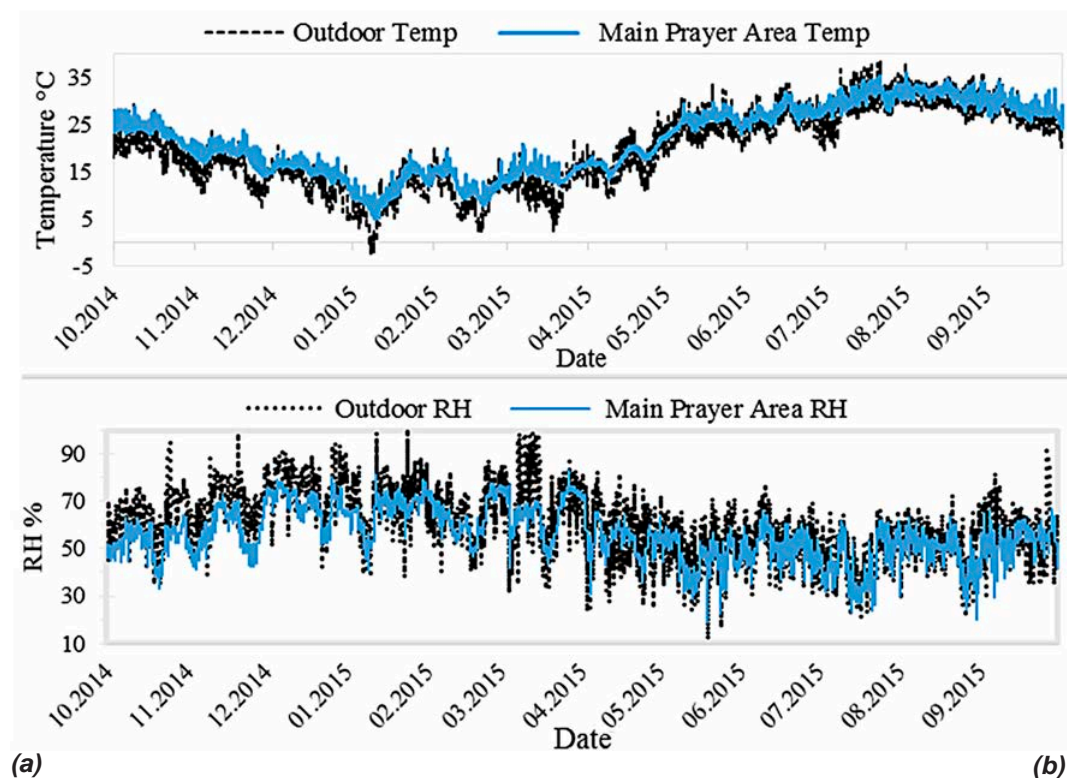

Figure 3. (a) Temperature (T), (b) relative humidity (RH) values for outdoor and main prayer area.

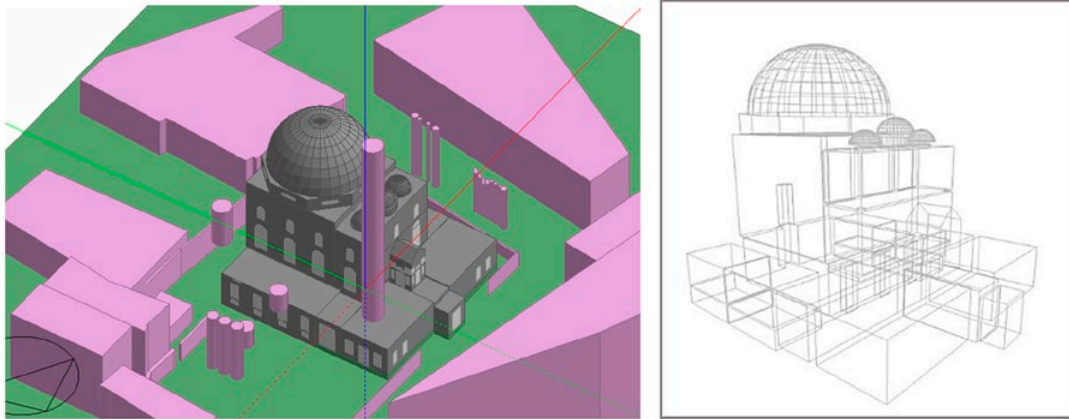

Figure 4. DesignBuilder model of the mosque and defined thermal zones.

Table 1. Errors of DesignBuilder model calibration

Error Indices	Months (2014–2015)												ASHRAE Guide- line 14
	Oct	Nov	Dec	Jan	Feb	Mar	Apr	May	Jun	Jul	Aug	Sep	
MBE (%)	-5.6	-9.3	-6.7	-8.8	1.7	-5	5.5	0.6	1	1.3	1.9	4.1	±10
CV(RMSE) (%)	6.9	10.6	9.5	14.1	7.6	12	9.4	3.7	3.5	4.5	3.9	6.8	30

3.2 MODELING AND CALIBRATION

Salepçioğlu Mosque was modelled along with surrounding buildings, trees, and the minaret by DesignBuilder v.4.2 and EnergyPlus v.8.1 [10–11], and composed of 26 inner thermal zones (Figure 4).

The model was calibrated with hourly measured indoor T data with respect to ASHRAE Guideline 14 [12]. The calibrated error ratios for the model is given in Table 1.

3.3 SIMULATION RESULTS

Following the calibration, the model was simulated for existing conditions (base case) and the four proposed intervention strategies. Simulation results were used to create adaptive comfort charts for each season based on the adaptive comfort model (with 80 % acceptability limit) of ASHRAE 55 [2], shown in Figure 5.

Table 2 exhibits season periods and the share of discomfort hours (%) in that period. Considering the baseline, it can be clearly seen from Figure 5 and Table 2 that the most comfortable season is autumn (42.4 % discomfort hours), while higher thermal discomfort is experienced during winter (100 % discomfort hours).

As far as the winter season is analysed, the best result is obtained by introducing an underfloor heating system, decreasing the discomfort hours to 45 % meaning significant improvement compared to the baseline. All other strategies failed to provide any improvement. The spring season was slightly more comfortable than winter, yet still more than half of the period is out of the 80 % comfort range (57.6 % discomfort hours). The application of underfloor heating effectively

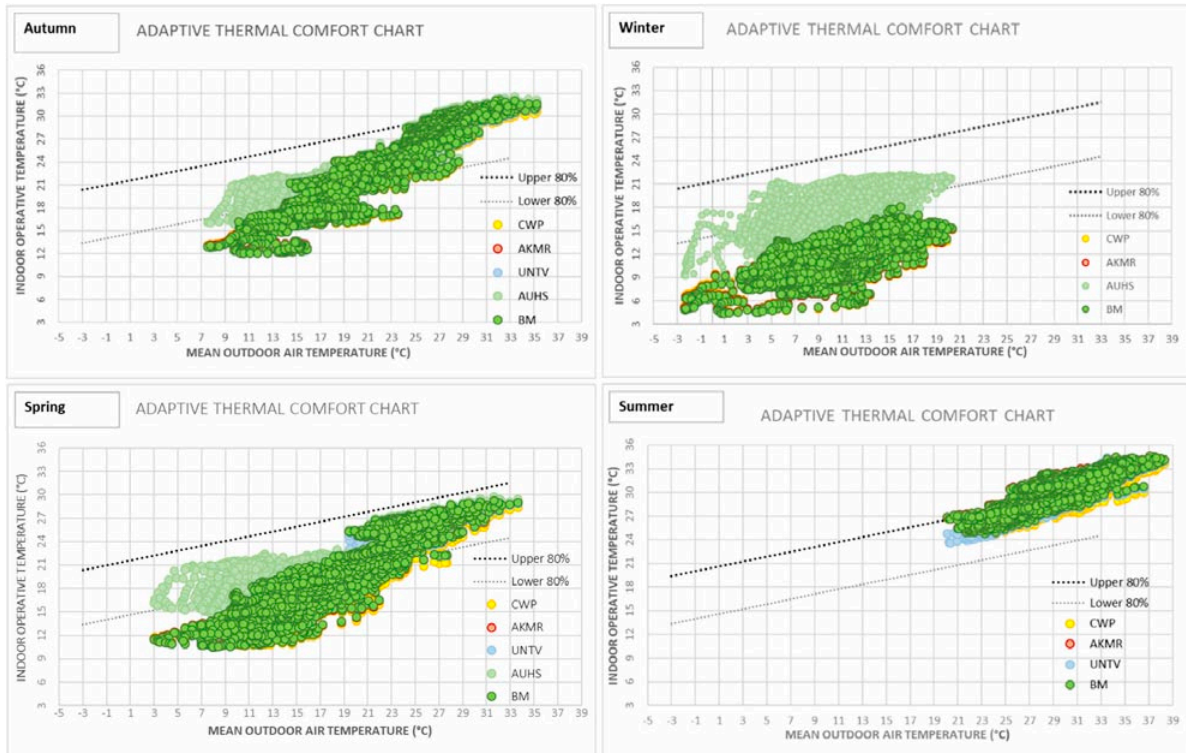

Figure 5. Seasonal adaptive comfort charts for baseline model and intervention strategies (BM: Baseline Model, CWP: Change of Window Panes, AKMR: Addition of Khorasan Mortar to the Roof, UNTV: Utilization of Night-Time Ventilation, AUHS: Application of Underfloor Heating System).

Table 2. Seasonal results of discomfort hours. Numbers in parenthesis indicate percentage improvements compared to the baseline model

Adaptive Discomfort (ASHRAE 55) (%)	Winter (12.2014, 01-02.2015)	Spring (03-05.2015)	Summer (06-08.2015)	Autumn (9.2015, 10-11.2014)
Baseline Model	100	57.6	57.1	42.4
Change of Window Panes	100 (0%)	59.8 (-2.2%)	52.5 (4.6%)	41.8 (0.6%)
Addition of Khorasan Mortar to the Roof	100 (0%)	57.4 (0.2%)	57.1 (0%)	42.2 (0.2%)
Utilization of Night-Time Ventilation	-	59.3 (-1.7%)	51 (6.1%)	41 (1.4%)
Application of Underfloor Heating System	45 (55%)	31.8 (25.8%)	-	13.1 (29.3%)

minimized the levels of discomfort down to 31.8 %, while addition of Khorasan mortar to the roof has an insignificant improvement (0.2 %). Change of window panes and utilization of night-time ventilation only led to worsened thermal comfort. During summer, baseline discomfort hours determined as 57.1 % were found to be improved by 6.1 % and 4.6 % with night-time ventilation and change of window panes, respectively. In autumn, which is the most comfortable season, only one of the intervention strategies, i.e. the use of underfloor heating system, strongly reduced the discomfort levels by 29.3 %.

4. CONCLUSIONS

Conservation of cultural and heritage values of historic buildings may predominate the thermal requirements of occupants. Salepçioğlu Mosque presents a vital case to search for an optimum balance between the preservation requirements and human comfort needs. The mosque underwent restoration between March and September 2012, with a specific attention to its conservation problems related to humidity, dampness and waterproofing.

The objective of this study was to emphasize that the intervention strategies should be implemented without any compromise of culture heritage value of historic buildings, while also considering the thermal comfort of the occupants. The results indicated that reaching thermal comfort levels in winter is the main problem of the mosque. The most comfortable season for main prayer area is the autumn period, while half of summers and springs are slightly below the acceptable levels of comfort which is tolerable by the occupants.

The utilization of underfloor heating is the most effective strategy for improving comfort conditions in winter, autumn and spring even though it was not approved by the local council, concerned as they were that it would cause damage to the wall paintings. A further study should be conducted on the risk assessment of micro-climate on the wall paintings and other objects in the mosque to show if the intervention strategies are acceptable.

Night-time ventilation improves indoor thermal comfort by 6.1 % in a passive manner in summer. Therefore, scheduling the night-time ventilation may be more preferable strategy in the Mediterranean climate. The other applicable strategies requiring physical interventions, such as change of window panes and addition of a layer to the roof, should be taken as the secondary retrofit actions, considering their lower impact.

5. ACKNOWLEDGMENTS

The authors would like to thank The Prime Ministry Directorate General of Foundation, Republic of Turkey, ENVAR Architecture and Engineering Inc., JEOMER-Izmir Institute of Technology and Prof.Dr. Sedat Akkurt for their support and help.

6. REFERENCES

- [1] J. Sateri. Performance Criteria of Buildings for Health and Comfort, 2014. CIB REPORT.
- [2] ASHRAE Standard 55 – 2010: Thermal Environmental Conditions for Human Occupancy. Atlanta: American Society of Heating and Air-Conditioning Engineers, Inc., 2010.
- [3] P. Fanger. Thermal Comfort. Analysis and Applications in Environmental Engineering. Copenhagen: Danish Technical Press, 1970.
- [4] S.P. Corgnati, M. Filippi and S. Viazzo. "Perception of the thermal environment in high school and university classrooms: Subjective preferences and thermal comfort." *Building and Environment*, 42 (2), pp. 951–959, 2007.

- [5] R. de Dear, G.S. Brager, J. Reardon and F. Nicol. "Developing an adaptive model of thermal comfort and preference / Discussion." *ASHRAE Transactions*, vol. 104, pp. 104–45, 1998.
- [6] J. Nicol, M. Humphreys. "Adaptive thermal comfort and sustainable thermal standards for buildings." *Energy and Buildings*, 34 (6), pp. 563–572. 2002.
- [7] S. Ibrahim, A. Baharun, M. Nawi and E. Junaidi. "Assessment of thermal comfort in the mosque in Sarawak, Malaysia." *International Journal of Energy and Environment*, 5 (3), pp. 327–334, 2014.
- [8] M.S. Al-Homoud, A.A. Abdou and I.M. Budaiwi. "Assessment of monitored energy use and thermal comfort conditions in mosques in hot-humid climates." *Energy and Buildings*, 41 (6), pp. 607–614, doi: 10.1016/j.enbuild.2008.12.005, 2009.
- [9] World Map of Köppen-Geiger Climate Classification, 2006.
- [10] DesignBuilder. (2015), Version 4.2.0.054. [On-line]. Available: http://www.designbuilder.co.uk/component/option,com_docman/task,doc_details/gid,53/Itemid,30/ [Aug. 12, 2015].
- [11] EP. (2015). "EnergyPlus Energy Simulation Software." [On-line]. Available: http://apps1.eere.energy.gov/buildings/energyplus/energyplus_about.cfm [Aug. 22, 2015].
- [12] ASHRAE Guideline 14 – Measurement of Energy and Demand Savings, Atlanta: American Society of Heating and Air-Conditioning Engineers, Inc., 2002.

A baroque hayrick as storage centre for pipe organs

Whole building simulation of different climatization strategies in the context of primary energy demand

S. Bichlmair, M. Krus and R. Kilian

Fraunhofer Institute for Building Physics, Holzkirchen, Germany.

Email: stefan.bichlmair@ibp.fraunhofer.de; martin.krus@ibp.fraunhofer.de; ralf.kilian@ibp.fraunhofer.de

Abstract – A refurbished baroque hayrick in Bavaria is being used as museum storage for pipe organs. The indoor air relative humidity is very stable in the unheated hayrick, but the level of relative humidity is overall too high. Therefore different climatization strategies to improve the situation are being compared and evaluated using whole building simulation. The comparison of energy consumption shows that at first sight dehumidification uses less energy to reduce high moisture levels than conservation heating by a Temperierung wall heating system. When primary energy is considered, it becomes evident, that also warm-water systems can have a good performance in terms of the overall CO₂ footprint, especially when renewable resources are used.

Keywords – museum storage, hygrothermal whole building simulation, climatization, HVAC-systems, primary energy, mould risk assessment

1. INTRODUCTION

1.1 A MUSEUM STORAGE IN A BAROQUE HAYRICK

An old palace at the small Bavarian village of Valley, houses a very special collection of historic pipe organs in a museum and cultural centre. A large number of these musical instruments are located nearby in an old wooden farm building that has been dated to the year 1780. Recently it has been redesigned as museum storage (see Figure 1).



Figure 1. The baroque hayrick at Valley Old Palace houses a large collection of pipe organs. Photos: Stefan Bichlmair.

As this building was relocated in 1991 from its original position at a farm in Oberdarching, close to Valley, it was thermally improved at the same time. At present it features core insulated walls made out of the ancient wood and insulating lime sand bricks as well as a special Temperierung wall heating system with copper pipes for warm water heat distribution. The pipes are fixed on the surfaces of the wooden cladding of walls and ceilings. This wall heating system has up to now not yet been put into use – mainly for reasons of energy saving.

1.2 CURRENT INDOOR CLIMATE

Climate measurements in the years 2013 to 2014 show that the building features a very stable climate over the course of a year with little variations of RH and a seasonal change of temperature. However, the overall relative humidity is unfortunately at a high level with half of the values above 70 %RH (median is 70.2 %RH) during the whole year. Half of the year (mostly spring and summer) the climate values indicate a possible risk of mould growth. The range of relative humidity lies between 62 %RH and 79 %RH with only a few hours up to 82 %RH. The temperature course varies between 0.3 °C and 23.9 °C with an annual average of 10.5 °C, see Figure 2. A more detailed analysis of the indoor climate with WUFI® Bio [6] shows a very low Mould index close to 0, meaning no risk of obvious mould growth, see Figure 3. Actually, mould has been observed on some surfaces of the musical instruments. This may be caused in former climatic situations or in moisture input while using the instruments or special local micro climatic situations.

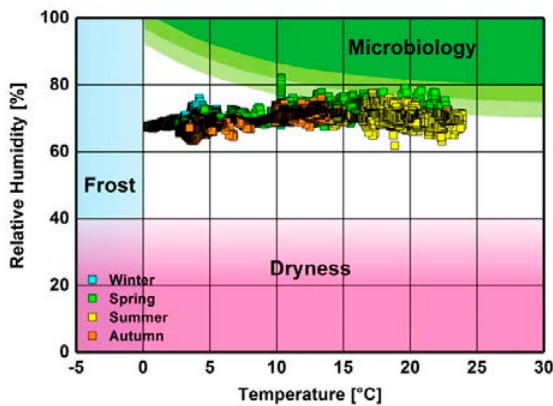
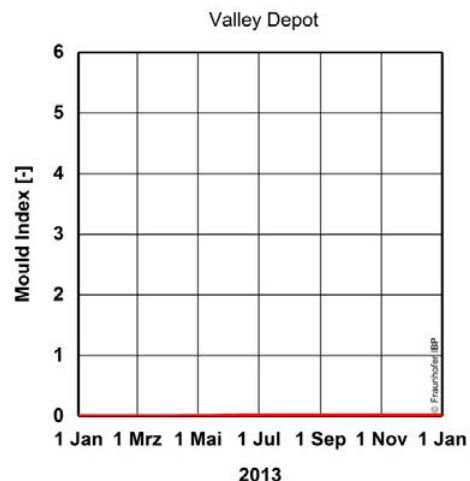

Figure 2. Indoor climate of the pipe organ storage in the baroque hayrick. Hourly values for the year 2013. The relative humidity fluctuations are very low although there is no active climate control. Due to high values of RH (average above 70 %RH) an increased risk for mould growth exists.

Figure 3. Calculated mould index using the climate conditions in the centre of the storage room.



The risk assessment shows no mould activity. However, mould is present and local microclimates may differ from the climate monitoring location.

2. WHOLE BUILDING SIMULATION

Hygrothermal building simulation allows the assessment and prediction of climate conditions in building components as well as in whole buildings. Thus, the effects of measures with regard to the indoor climate, or the modification of building components or the construction, can be tested and assessed beforehand. The question of quality, and thereby validity of these forecasts within the context of risk assessment in preventive conservation, is of significant importance, since decisions made on the basis of these predictions have far-reaching effects on the preservation of precious artefacts.

By coupling several one-dimensional hygrothermal models a whole building model is generated, which does not only give temperature and humidity profiles in building components as a result but also the indoor climate and the energy balances. They are calculated in dependence of outdoor climate, surface areas and internal influences such as users, visitors, moisture in building components, heating or ventilation and air-conditioning systems or other sources, and sinks of humidity and heat. A recent development is the combination of hygrothermal calculations of building components with the energetic building simulation [2].

The advantage of these tools for preventive conservation is that they allow the assessment of different measures in buildings in advance, e.g. change of heating system, thermal insulation of historic building constructions or sealing of windows. These simulations can also partially replace long-term real experiments for complex problems or supplement them by variant calculation. Due to the existing uncertainties of the input parameters, the exact calibration of the models and plausibility testing of the results is essential to assure the accuracy of results. An example for a hygrothermal room model is WUFI® Plus developed at the Fraunhofer IBP. The software was validated in numerous tests [3], among other in a common exercise of the EU Project Climate for Culture [5].

For the simulation of the baroque hayrick, a rather simplified model was developed and the input parameters were adjusted step by step using one year of measured data for the calibration until a satisfactory fit of simulation and reality was reached (Figure 4).

Locally measured outdoor air temperature and relative humidity were used as outdoor climate boundary conditions and completed by additional weather data from the Holzkirchen station (about 5 km distance). For the stored organs, additional internal hygrothermal active masses were introduced into the simulation model in the form of 56 m³ of wooden elements with a hypothetical thickness of 2 cm and of 8 cm respectively. The air exchange rate by infiltration was assumed to be 0.5 h⁻¹ in winter and 0.8 h⁻¹ during summer.

The overall quality of the hygrothermal whole building simulation model was assessed after [4]. The fit between simulation and measured indoor climate was in most aspects excellent and in some minor ones acceptable.

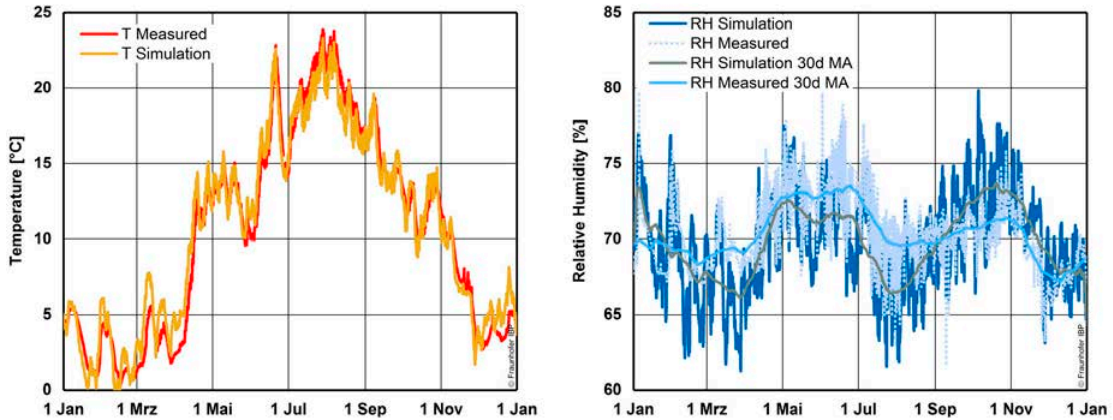

Figure 4. Measured indoor climate of the pipe organ storage vs. results from hygrothermal whole building simulation with WUFI Plus from January 2013 to January 2014. The Temperature is very well represented by the simulation and also the general level of RH even though here are some minor deviations.

3. CLIMATIZATION SCENARIOS

Having a calibrated whole building simulation model available, the next step introduced and compared different climatization scenarios, such as dehumidification, and constant or conservation heating. For the comparison of systems not only the energy demand is taken into account but also the primary energy use. The overall aim was the reduction of the level of relative humidity and thus also of the mould risk. The following strategies were simulated and compared to the simulation of the “natural” indoor climate (free sliding) with the same simulation model:

- Temperierung wall heating with standard heating curve;
- Minimum heating to 5 °C;
- Hygrostatic conservation heating to max. 60 %RH;
- Dehumidification to 60 %RH without Temperierung wall heating.

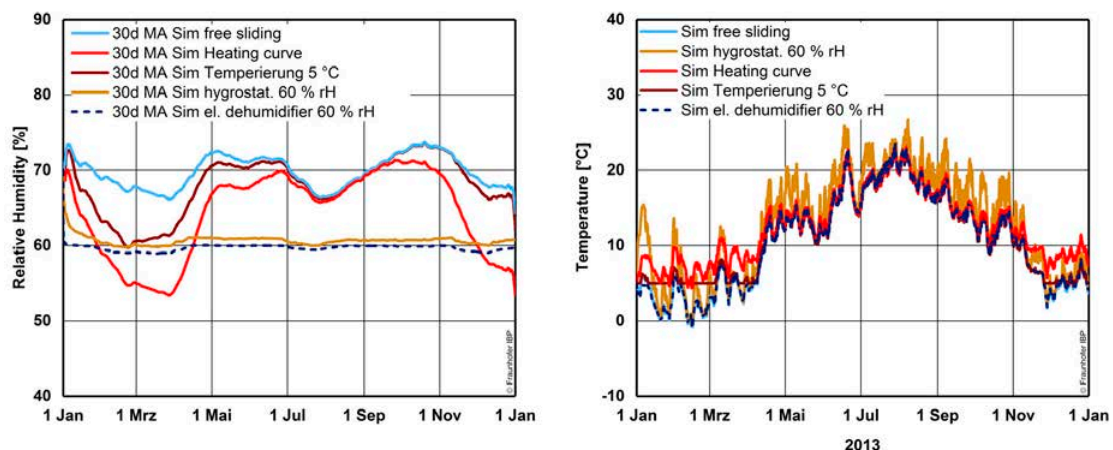

Figure 5. Monthly moving average (30d MA) values of the hygrothermal whole building simulation of different climatization strategies in comparison to the simulated natural (free sliding) indoor climate. Hygrostatic heating to 60 %RH as well as dehumidification show the best results in terms of indoor climate stability.

The two scenarios with heating to a minimum temperature of 5 °C and heating with a standard heating curve, lead to higher temperatures during winter and at the same time to lower relative humidity (Figure 5, left). During summer none of the systems do operate. Therefore the relative humidity rises well above 60 and even above 70 %RH. Both other systems, hygrostatic conservation heating and dehumidification, secure the wanted level of relative humidity inside the storage building around 60 %RH constantly. It can also be observed that due to the high hygric and thermal masses inside the archive, rather stable conditions are reached. In regard to indoor air temperature, dehumidification does not change the course of the “natural” indoor climate at all. Conservation heating will lead – in clear accordance with the underlying principle of adjusting the level of relative humidity by controlling the temperature – to higher indoor air temperature, also during the summer months (Figure 5, right).

4. ENERGY EFFICIENCY OF HVAC SYSTEMS

Hygrothermal whole building simulation cannot only help in assessing the quality of indoor climate, but makes it also possible to receive rough estimates of energy use for different heating or climatization systems and strategies.

For the comparison real existing heating systems were implemented. A real sorption dehumidifier can take 2.2 kg/h of moisture out of the air, using 2.9 kW/h. For the size of the museum storage two such machines are necessary to secure the 60 %RH target. The Temperierung heating system can provide about 30 W/m of pipe length, if the system will run with a max. over-temperature of 50 Kelvin. For 430 m overall length of pipes with a diameter of 15 mm this leads to a maximum heating power of 13 kW. In the simulation this was reduced to max. 8 kW heating power which was sufficient for reaching the 60 %RH target of the hygrostatic conservation heating strategy. Since the existing Temperierung system in the hayrick has never been put to use, no real-life data are available. The cumulative curves of heating power (Figure 6) show that heating for maintaining a minimum temperature of 5 °C do not use much power compared to the other heating strategies but will not improve the indoor climate either (Figure 5). Also the heating strategy with heating curve is not improving the

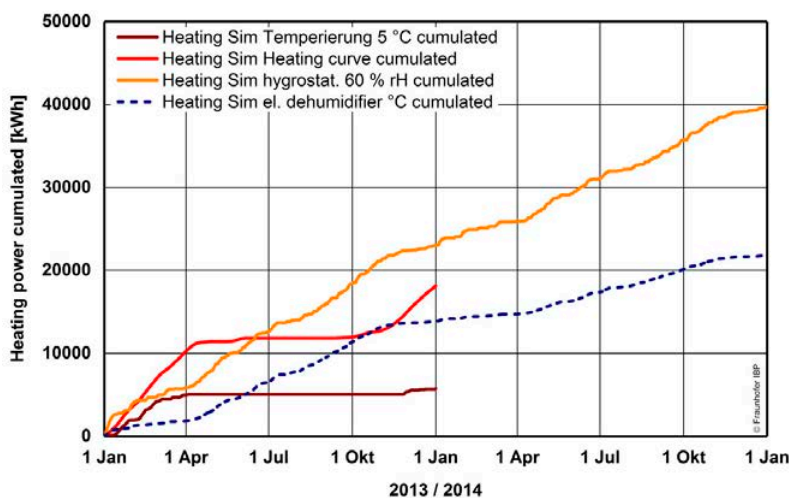

Figure 6. Cumulated heating power results from Hygrothermal whole building simulation for the different climatization strategies. The energy use for Hygrostatic heating to 60 %RH is almost double compared to dehumidification.

indoor climate sufficient, but has considerably energy needs. Heating with hygro-static heating to reach 60 %RH with the Temperierung system has a significant higher energy use, especially compared to dehumidification. For the first year ca. 23.000 kWh are estimated and for the second year still 17.000 kWh. Dehumidification needs about half the amount of energy; the pure electric power used was approximately 14.000 kWh in the first and 8000 kWh in the second year.

5. PRIMARY ENERGY COMPARISON

For comparison of the different energy sources (electricity, petroleum gas and wood pellet) on the impact of primary energy demand, the concept of primary energy factor of the German code DIN V 18599 [1] is used, see Table 1. In a simplified approach, the building energy demand for heating or dehumidifying Q_h is multiplied by the primary energy factor f_p to get the primary energy Q_p , as in (1), not taking into account the technical heat losses for control and emission, distribution, storage losses and generation at building level.

$$Q_p = Q_h \cdot f_p \quad (1)$$

Q_p Primary energy

Q_h Energy demand building by heating or dehumidifying

f_p Primary energy factor

Table 1. Energy sources and primary energy factor according to DIN V 18599 [1]

Energy source		Primary Energy factor f_p not renewable
Fossil fuel	Heating oil	1,1
	Petroleum gas	1,1
Biogenous fuel	Wood (e.g. wood pellets)	0,2
Electricity	German Electricity mix	2,4 ; since 2016: 1,8

To compare the overall environmental impact of the different climatization strategies for the pipe organ museum storage each system is multiplied with the relevant primary energy factor. The left graph in Figure 7 shows the cumulated primary energy demand for one year, based on the results of the whole building simulation. As electric energy is becoming constantly more and more sustainable, the primary factor has been reduced from 2.4 to 1.8 in 2016 for the non-renewable share of primary energy. This trend will probably go on in the future when the renewable energy share of electricity production will increase. Gas and other fossil fuels have a factor of 1.1. Energy sources from renewables like wood can even have a factor below 1, in the case for wooden pellets it is 0.2 for the non-renewable share of the primary energy. Taking all this into account, conservation heating with gas becomes comparable in primary energy use with dehumidification. When using wood as fuel, only about a quarter of primary energy is needed compared to electric energy. For a more exact and comparable

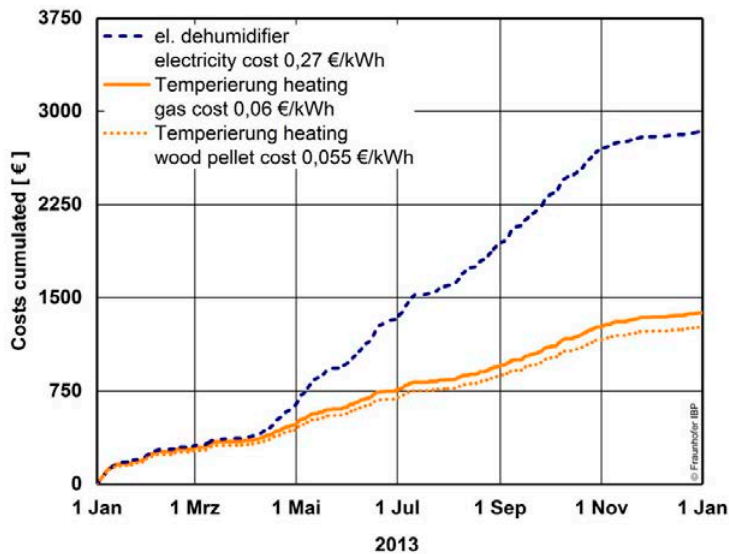
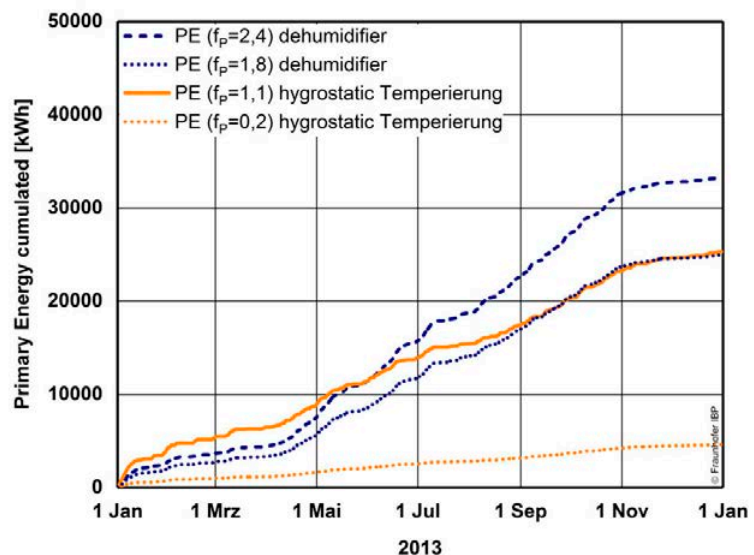

Figure 7. Cumulated primary energy use (above) and energy costs (right) from whole building simulation for Temperierung heating vs. dehumidification. Electric energy for dehumidification has a primary energy-factor of 2.4 and since 2016 of 1.8 while it is 1.1 for Temperierung with gas as fuel and with renewable resources like wood pellets as low as 0.2. Also energy costs are considerably higher for dehumidification.



assessment, DIN V 18599 (2016) “Energy efficiency of buildings – Calculation of the net, final and primary energy demand for heating, cooling, ventilation, domestic hot water and lighting“, can be used.

The fuels costs for gas are ca. 0.06 €/kWh while the costs for electric energy currently lie at ca. 0.27 €/kWh. With an estimated price of 0.22 €/kg for wooden pellets and a caloric value of 4.8 kWh/kg, this leads to energy costs of ca. 0.06 €/kWh when assuming an overall 80 % degree of efficiency. Compared to electricity, this means a factor of 4.5 in regard to costs. This makes Temperierung conservation heating considerably more cost efficient in this case. The right graph in Figure 7 shows the cumulated costs for one year.

6. CONCLUSIONS AND OUTLOOK

When trying to find a decision which climatization system and strategy are best for a certain task in a historic building, hygrothermal whole building simulation can be a useful tool to assess the quality of the indoor climate. Simulations can

also give a first estimate of energy use as well as costs beforehand. The central precondition is a reliable and tested simulation model. The question of local microclimates in certain areas of the room due to humidistat heating or hygrostat dehumidification cannot be answered with this simulation study. Since the assessed climate was measured and simulated in the middle of the building, local microclimate in the vicinity of floors or outside walls may be worse, and thus the mould growth risk could be higher here.

Simulation for the baroque hayrick at Valley showed that conservation heating is more efficient both in terms of primary energy use and costs. However, as low temperature is favourable to reduce chemical decay rates and activity of micro-biological pests, dehumidification can still be considered as an alternative in regard to aspects of preventive conservation.

Investment costs into materials and systems were not investigated in this very simplified examination. For a more detailed estimation of costs, separate calculations are necessary for each individual case.

7. ACKNOWLEDGMENTS

The examinations of the organ pipe storage in a baroque Hayrick were part of a research project about Temperierung heating in Bavaria (Germany) funded by the German Volkswagen Foundation [7, 8, 9].

8. REFERENCES

- [1] DIN V 18599 (2016): "Energy efficiency of buildings – Calculation of the net, final and primary energy demand for heating, cooling, ventilation, domestic hot water and lighting". Beuth Verlag 2016.
- [2] H.M. Künzle, A. Holm, D. Zirkelbach, A.N. Karagiozis, (2005): "Simulation of indoor temperature and humidity conditions including hygrothermal interactions with the building envelope". In: *Solar energy* (78), pp. 554–561.
- [3] F. Antretter, F. Sauer, T. Schöpfer, A. Holm (2011). "Validation of a hygrothermal whole building simulation software". Proceedings of Building Simulation 2011: 12th Conference of International Building Performance. Simulation Association, Sydney, Australia.
- [4] R. Kilian. "Klimastabilität historischer Gebäude – Bewertung hygrothermischer Simulationen im Kontext der Präventiven Konservierung". Dissertation. Universität Stuttgart. Fraunhofer IRB Verlag, Stuttgart 2013 Available online: <http://publica.fraunhofer.de/documents/N-264923.html>
- [5] Leissner, Johanna; Kilian, Ralf; Kotova, Lola; Jacob, Daniela; Mikolajewicz, Uwe; Broström, Tor; Ashley-Smith, Jonathan; Schellen, Henk; Martens, Marco; van Schijndel, Jos; Antretter, Florian; Winkler, Matthias; Bertolin, Chiara; Camuffo, Dario; Simeunovic, Goran and Vyhliđal, Tomáš: "Climate for Culture: Assessing the impact of climate change on the future indoor climate in historic buildings using simulations". In: *Journal of Heritage Science* (2015) 3:38.
- [6] K. Sedlbauer (2001): Vorhersage von Schimmelpilzbildung auf und in Bauteilen. Dissertation Universität Stuttgart 2001.

- [7] BLfD (Hrsg.) (2014): Die Temperierung – Beiträge zum aktuellen Forschungsstand. Schriftenreihe des bayerischen Landesamtes für Denkmalpflege Nr. 8. Volk Verlag, München.
- [8] Bichlmair, S., Raffler, S.; Kilian, R. (2015): The Temperierung heating systems as a retrofitting tool for the preventive conservation of historic museums buildings and exhibits. In: *Energy and Buildings* (95), pp. 80–85.
- [9] Bichlmair, S.: Die Temperierung und die Erhaltung von Gebäuden in traditioneller Bauweise – Wirkung auf Raumklima und Baukonstruktion. Dissertation in progress.

Study of the indoor microclimate for preventive conservation and sustainable management of historic buildings

The case of Villa Barbaro, Maser

A. Bonora, K. Fabbri and M. Pretelli

Dept. of Architecture, University of Bologna, (UniBO), Bologna, Italy.

Email: anna.bonora3@unibo.it; kristian.fabbri@unibo.it; marco.pretelli@unibo.it.

Abstract – In recent years, there has been an increasing awareness of the need for proper and sustainable management of historic buildings – energy efficiency and availability must go hand in hand with preservation. To find solutions, we propose a new concept: Historic Indoor Microclimate (HIM). The HIM is used to find out the building's history, considering how and what has changed inside and outside the building over time (destination of use, plant, climate changes, etc.). Moreover, this study identifies a magnitude index to assess the microclimatic risk. The case study presented shows the results of research carried out in 2016 and applied to Villa Barbaro, Maser, which concerns the evaluation of the indoor microclimate through monitoring and planning of the management of this building. It permits to guarantee a better energy efficiency; the preservation of the historic building and of the collections and artefacts inside it, and to increase the level of visitors' comfort.

Keywords – historic buildings; sustainable; energy efficiency; Historic Indoor Microclimate (HIM); microclimatic risk

1. INTRODUCTION

This paper reports the results obtained from the indoor microclimate monitoring campaign of an historic building: Villa Barbaro, built in Maser between 1554 and 1560 by the architect Andrea Palladio and registered on the UNESCO World Heritage Site list from 1994, as Palladian Villa of Veneto [1].

Regarding the subject of indoor microclimate in the area of museums, it already exists literature, for example Thomson [2], Camuffo [3, 4] about deterioration and microclimate monitoring (indoor and outdoor); also in Italy this is an issue which has been particularly emphasized, for example by Bernardi [5]; others as de Guichen [6] have proposed specific methodologies for museums.

Furthermore, there is a crucial connection between indoor microclimate and architectural configuration, deduced from the study of Historic Indoor Microclimate (HIM). The definition of the HIM concept was conceived by Fabbri [7] and Pretelli [8–10], as a result of a series of research on several historic buildings on the UNESCO heritage list. The HIM approach refers to the historic buildings' indoor microclimatic conditions, in contrast to the traditional one, which

usually consists of a study on the specific conservation artefacts' range. Once a sound knowledge of the indoor microclimate is acquired, it is possible to verify and to simulate the state of conservation of the objects.

2. GOALS

This paper is aimed to describe a specific methodology which has proved to be successful to find the right management of historic buildings' conservation. This methodology has proven effective in evaluating the effects of indoor microclimate parameters' changes on the thermal comfort of visitors, and at the same time on the conservation of artefacts kept inside historic buildings.

The best strategy to preserve the cultural heritage is the one that allows to detect in time any potential risk situations, due to microclimate, and setting alert thresholds. For that reason, considering all the microclimatic variables and their continuous changes in time and space, this study wants to define and to calculate a magnitude index to assess the "Heritage Microclimate Risk" (HMR).

3. CASE STUDY

Villa Barbaro (Figure 1) is characterised by the presence of many frescoes, realised by Paolo Caliari, so-called "il Veronese" (Figure 2); it was built in a suburban estate of about 230 hectares. The central part of the building is on two levels. On each side there is a porch and the front is about 16 meters, equivalent of 1/3 of the building's depth. Due to the tilted soil, the lower level is a basement, connected with the main floor by backstairs. The masonry structure is a typical three-layered one: the two external façades enclose an internal less regular brickwork (the so-called "a sacco" typology). The external walls of this architecture are about 0.80 m thick. The stone is used just for the decoration: capitals

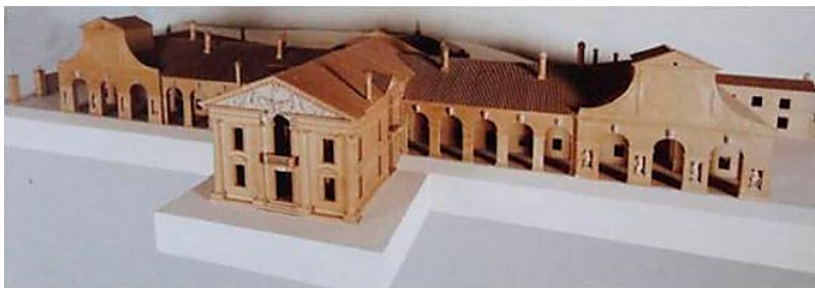

Figure 1. Maquette of Villa Barbaro, scale of 1:33. Credits: G. Beltraimini, H. Burns, Palladio, Marsilio, Venice, 2008, p.123 [11].



Figure 2. Indoor frescos: Croce centrale (left) and Sala dell'Olimpo (right). Photo: A. Bonora.

and frames. The doors and the windows' fixtures are in wood; there are single-glazed windows and hollow slab roof.

Nowadays, Villa Barbaro, one of the most famous of Palladio's Villas, is used partially as a museum and partially as a house inhabited: there are only six rooms accessible to the public and three of those have been monitored during the monitoring campaign illustrated below.

4. RESEARCH METHODOLOGY

4.1 LEVELS OF ANALYSIS

The proposed methodology is structured as follows: (a) the archive search, (b) the monitoring campaign, (c) the virtual building modelling, by a dynamic software (IESVE [12]), and (d) the calculation of the percentage of the Heritage Microclimate Risk (HMR).

The first phase is about the acknowledgment of the fabric and it is constituted by the bibliographic and archival research and by the monitoring campaign. The second one is about the realization of a virtual building model of Villa Barbaro. The aim of this monitoring is to measure the Villa's indoor microclimate and the creation of a virtual building model of it, which allows evaluating the physic behaviour of the indoor microclimate through thermo/fluid-dynamic simulations, making possible the elaboration of some hypothetic microclimate improvements scenarios. Moreover, the measurements obtained from the monitoring and the virtual building simulations, allow to assess the percentage of the HMR to which the artefacts are subject.

4.2 ARCHIVAL RESEARCH

During archival research, the geometrical, structural and thermo-physical characteristics of the historic building have been verified, as also some information about the use of the building. Moreover, an oriented reading of "The Four Books of Architecture" has been done, to find the passages in which Andrea Palladio provides indications and suggestions (Palladio [13]). We also used the graphic products elaborated between 1968 and 1981, by the International Centre of Architectural Studies Andrea Palladio (CISA [14]): the architectural surveys of Villa Barbaro, have been crucial for the realization of the virtual building model, which is fundamental for an in-depth and realistic study and energy analysis of the building.

4.3 MONITORING CAMPAIGN

The installation of the monitoring system at Villa Barbaro has been possible thanks to the collaboration with Henesis company, and the specific instrumentation used are the following: probes to monitor microclimatic parameters (air temperature, relative humidity, CO₂ concentration); Beesper bridge, that is a data grab able to transmit data to an internet platform; and Beesper console, namely an online platform used to a remotely visualization of data. The monitoring campaign had a duration of 6 months (from 21/06/2016 to 9/12/2016) and we

monitored three of the six rooms open to the public. We placed the bridge in the Croce Centrale and the probes in Croce Centrale, Stanza del Cane and Tribunale d'Amore. In the layout (Figure 3) these rooms correspond respectively to number 1, 2 and 3. Due to a failure of a probe, we could not retrieve data from the room (2) Stanza del Cane.

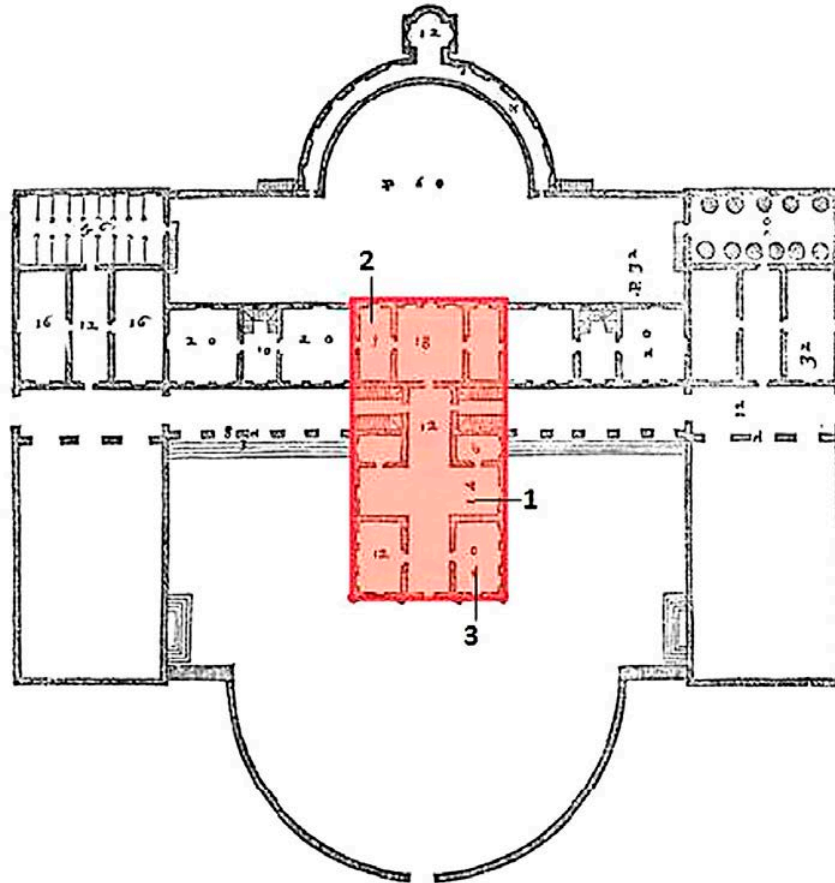

Figure 3. Layout of Villa Barbaro, Maser, Scale of 1:100. In red the rooms open to the public, and with numbers (1) Croce Centrale, (2) Stanza del Cane e (3) "Tribunale d'Amore": rooms where the probes have been placed. Credits: CISA A.Palladio, Vicenza.

Table 1. Instruments characteristics

R ²	Accuracy range	Measurement range
Air temperature	±0.5 °C	0–50 °C
Relative humidity	±3 %	20–80 %
CO ₂ concentrations	±50 ppm	0–5000 ppm
Contact temperatures	±0.5 °C	0–50 °C



Figure 4. Location of probes. Beesper Bridge in the room "Croce Centrale" (top); Beesper Node in the room "Stanza del Tribunale d'Amore" (central); Beesper Node in the room "Croce Centrale" (bottom). Photos: A. Bonora.

4.4 BUILDING SIMULATION

The realization of the virtual building model of Villa Barbaro, allows to elaborate selected microclimate improvement scenarios. The strength of the proposed methodology lies in the possibility to pre-emptively define, throughout a virtual building model, which actions could aid the preservation of the artefact, avoiding the risk component that would be taken working on the original.

Thanks to the layout of the building, we made a first virtual building model using the software AutoCAD, uploaded on SketchUp, to realise the 3D model of Villa Barbaro. Downloading a plug-in, we transferred the model on IES.VE (Virtual Environment by Integrated Environmental Solutions: software BIM – Building Information Modeling): a dynamic simulation software used to elaborate analysis of buildings' sustainable energy performances. IES.VE returns information about energy use, CO₂ emissions, occupant comfort, light levels, airflow, etc., through data, images and videos.

The Building Simulation, realised through IES.VE, consists on the use of the virtual building model, which allows to examine several specific aspects of a

building. It permits to study the performance of the building: indoor microclimate, lighting, energy, human behaviour, acoustics, indoor air quality, etc. Also, IES.VE allows to assess the Computational Fluid Dynamics (CFD): a simulation of the fluid dynamic behaviour of the air, indoor and outdoor, resulting from natural ventilation. To be certain that the simulations' outputs are reliable, we must insert geographic, architectonic, stratigraphic and climatic information about the building. In this way, the software can calculate and consider all materials' thermo-physical properties.

5. RESULTS

The most relevant data recorded are those about air temperature (T) and relative humidity (RH), which present a rather similar trend between the two rooms analysed. About the first parameter, the probes have recorded high summer temperatures, considering the fact that we are studying an indoor environment (temperatures reach 30 °C) and low temperatures in winter (temperatures lower than 7 °C); the RH values are inversely proportional to those of the T and for each room the RH is from 35 % to 80 %. The data recorded by probes have been compared with those obtained by the IES.VE simulations and they matched: the validation of the virtual building model has been confirmed comparing the software's result with measurements. The virtual building model has been validated through the monitoring campaign data, as reported in Table 1.

Considering the benchmarks of T and RH, defined in UNI 10829 [15] and by the MIBACT [16], we have calculated the HMR to which the frescos inside Villa Barbaro are exposed. By reference to the category of "inorganic materials/articles", we have considered:

- Air Temperature $hr_{(t,set),min} = 15 \text{ °C}$ and $hr_{(t,set),max} = 25 \text{ °C}$;
- Relative Humidity $hr_{(RH,set),min} = 20 \text{ %}$ and $hr_{(RH,set),max} = 60 \text{ %}$

The HMR caused by the RH is 32,31 % in the room Croce Centrale and it is 33,78 % in the room Tribunale d'Amore; instead the HMR due to the T is 86,91 % in the room Croce Centrale (Figure 4) and it is 84,38 % in the room

Table 2. Validation parameters for the Building Simulation

Validation parameter	Accuracy range	Room Croce Centrale	
MBE	2.01 %	1.92 %	MBE (Mean Bias Error) Validate if $MBE < 10 \text{ %}$
CV (RSME)	13.00 %	13.37 %	coefficient of variation root-mean-square error (RMSE) Validated if $CV (RMSE) < 30 \text{ %}$
PEARSON	0.95	0.94	Pearson Correlation Coefficient if $> 0.7 = \text{strong correlation}$, if between $0.3 - 0.7 = \text{correlation}$
Coefficient of determination R^2	0.89	0.87	Validated if $R^2 > 0.5$

Tribunale d'Amore (Figure 5): much higher than the percentage of risk estimated for the RH in each room.

We have calculated the HMR as follows: in Excel we estimated the number of hours in which the RH and the T do not comply with the above-mentioned range, considered optimal for the frescos' preservation; we divided the sum of these hours – during which the frescos are under HMR – for the accumulated hours of

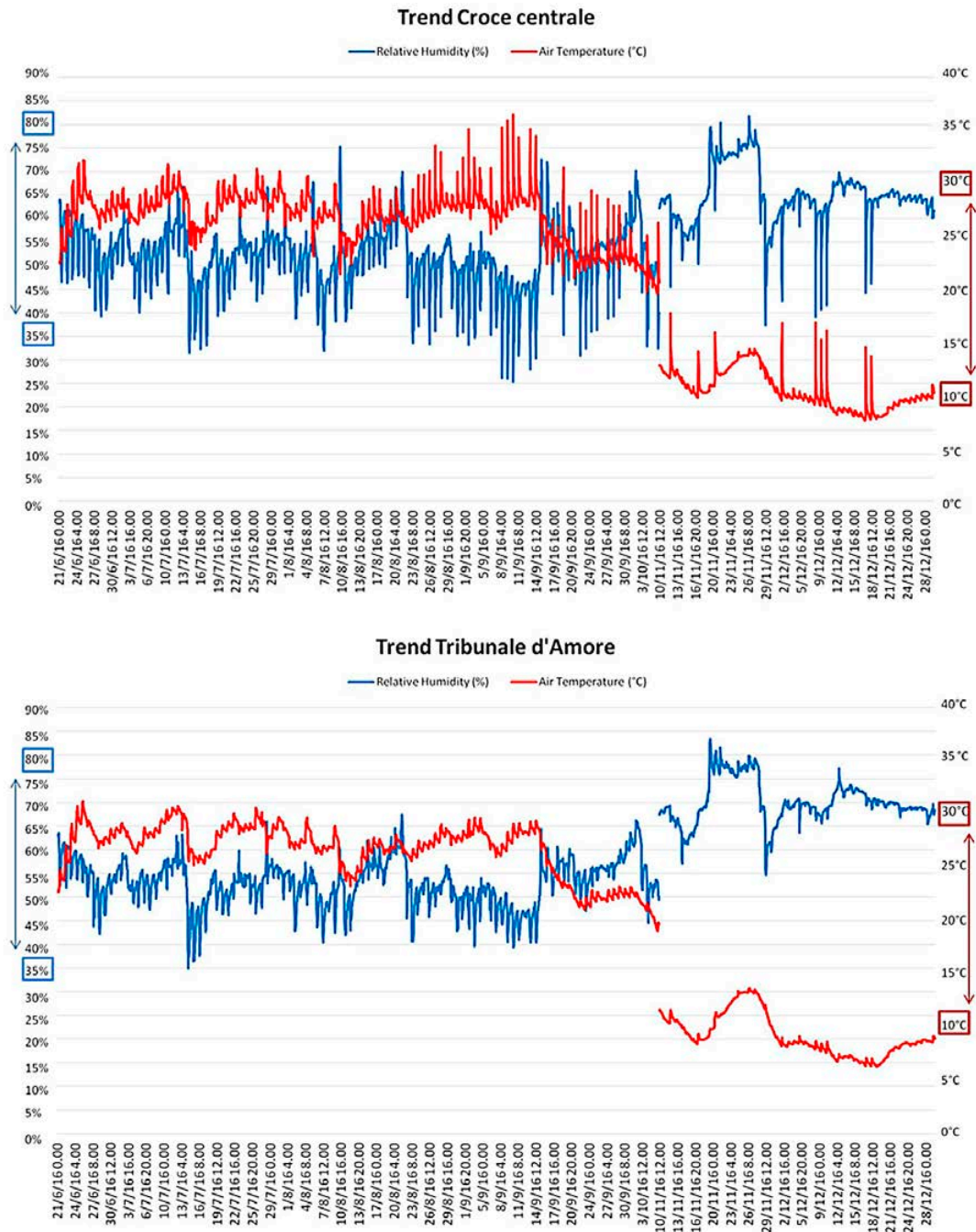

Figure 5. Air Temperature and Relative Humidity Trends, Room (1) Croce Centrale (top); Room (3) Tribunale D'Amore (bottom).

the monitoring campaign's duration. The result obtained, converted in percentage, is the percentage of the HMR to which the frescos have been exposed during the six months of monitoring. $RM = \text{rmh/h} [\%]$ where :

“*rmh*” is the HMR for hours: $\text{rmh} = 1$ if $R_{hi} > R_{set}$ or $R_{hi} < R_{set}$

“*h*” are the total hours on which the HRM is calculated

6. PROSPECTED SCENARIO

As showed by data presented above, the parameter which more jeopardise the conservation of the Villa Barbaro's artefacts is the T. For this reason we propose a controlled management of the indoor T, through the activation of the HVAC system (currently inactive on the main floor of Villa Barbaro). This hypothesis leads to a marked improvement of visitors' comfort and of the microclimatic conditions for the conservation of the frescos: we set on IES.VE a set-point of 18 °C for the heating and 24 °C for the air conditioning (Figure 4 and 5). The dotted red lines indicate the standards' ranges defined in UNI 10829 [15] and by the MIBACT [16].

Comparing a scorching summer day, the 2nd July, and a highly cold winter's day, the 29th December, the T simulated respects the regulatory standards, and the values of the Predicted Percentage of Dissatisfied (PPD) reach peaks less than 10 %, instead of the 90 % inside the analysed rooms in the present circumstances (Figure 6). Nevertheless, the visitors' comfort can be considered irrelevant for this case study because the duration of visits is very short, about an hour.

To evaluate the PPD, we assumed a level of sedentary activity in summer (69.8 W/m², which is the equivalent of about 1.1 met) and the use of summer

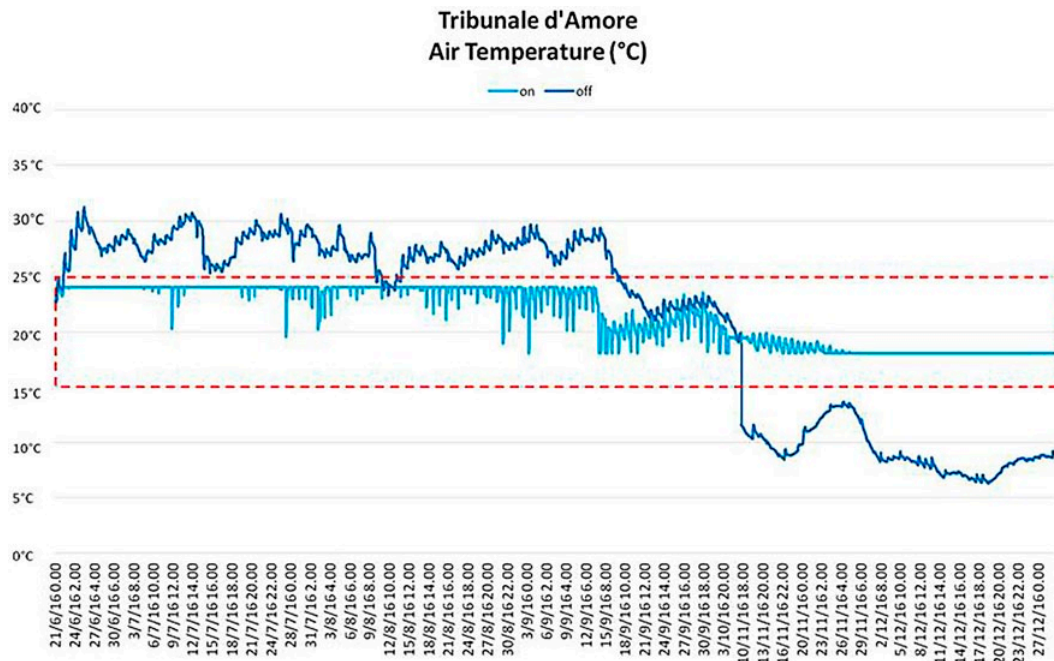

Figure 6. Air temperature trend by building simulation HVAC-ON and HVAC-OFF Scenarios, Room Croce Centrale.

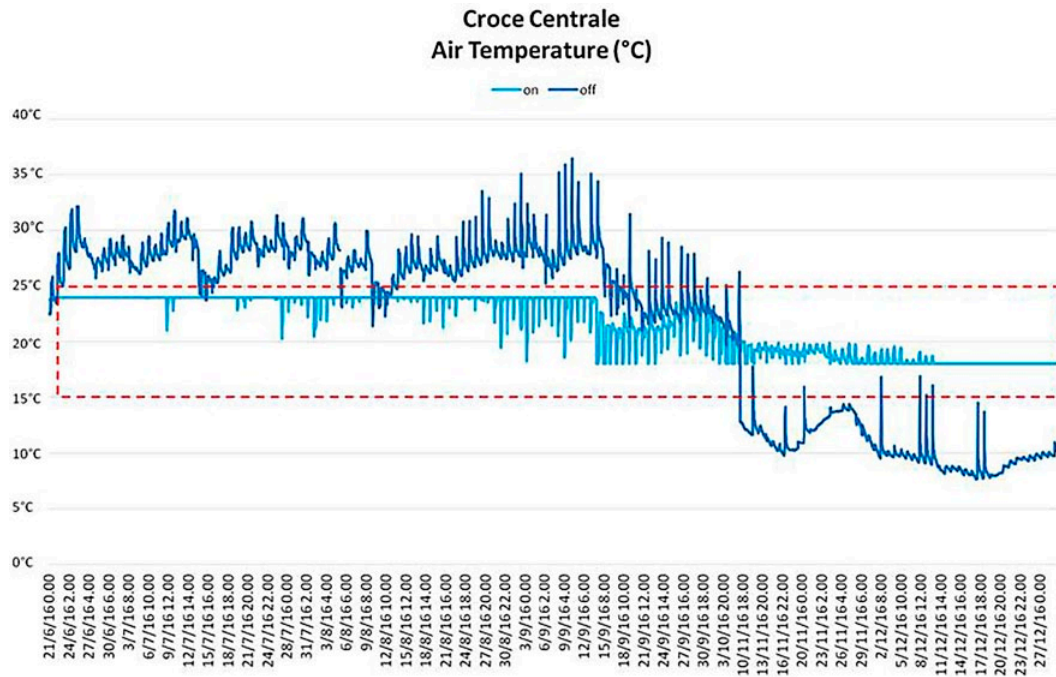

Figure 7. Air temperature trend by building simulation HVAC-ON and HVAC-OFF Scenarios, Room Tribunale d'Amore.

clothes, from which a thermal clothing resistance of 0.2 clo is obtained. For the winter period, we assumed a level of sedentary activity too (69.8 W/m^2), but with winter clothes: 1.2 clo of thermal resistance. Moreover, it is noted that all results over the comfort and discomfort PPD evaluation of visitors are related to a standard user, who stays in the room as provided for by ISO 7730.

7. CONCLUSIONS

The methodology adopted for this case study is extremely simple and low cost, both in terms of probes purchasing, data collection and management: characteristics that suggest a large-scale replicability. The study of buildings' indoor microclimate permits to make decisions about architectural and managerial changes, as the choice of HVAC systems, to reduce energy consumption.

Obviously, the virtual building model has its limits: during the fluid-dynamic simulation, for example, analysing open spaces with several glazed areas, we can find thermal imbalances errors; moreover, we can't know what happens under a layer of plaster. Nevertheless, the virtual building model allows to verify eventual building damage in a preventive way. Furthermore, the possibility of using a single indicator, as the HMR index, permits to avoid certain difficulties due to the utilisation of many different standards.

This methodology prompts the use of the building simulation to simulate the virtual environmental model of the historical buildings that, once validated, permit the hypothesis of management of present or future scenarios. Moreover, the possibility to control the environmental parameters which influence the microclimate, enables to define which actions could aid the preservation of the cultural

heritage analyzed and to understand the structural or transitional deterioration causes: crucial steps to set up a database for restoration projects. It also permits to monitor if the legally determined parameters are respected.

For all these reasons, it is considered that the case study of Villa Barbaro could show the efficacy of the methodology proposed to improve the approach of the so-called “preventive restoration”.

8. REFERENCES

- [1] UNESCO City of Vicenza and the Palladian Villas of the Veneto, 1994, website: <http://whc.unesco.org/en/list/712/> (last visit 4/1/2018).
- [2] Thomson G. *The museum environment*. 2nd ed. London: Butterworth-Heinemann, 1986.
- [3] Camuffo D. *Microclimate for Cultural Heritage*, Elsevier, Amsterdam, 1998.
- [4] Camuffo D., Brimblecombe P., Van Grieken R., Busse H.J., Sturaro G., Valentino A., Bernardi A., Blades N., Shooter D., De Bock L., Gysels K., Wieser N., Kim O., *Indoor air quality at the Correr Museum, Venice, Italy*, *Sci. Total Environ.* V.236, 1999, pp. 135–152.
- [5] Bernardi A. *Microclimate Inside Cultural Heritage Buildings*, Il Prato Casa-Editrice, Padova, 2008.
- [6] De Guichen G. *Medio siglo de Conservación Preventiva. Entrevista a Gaël de Guichen*, *Medio siglo de Conservación Preventiva. Entrevista a Gaël de Guichen*, *Ge-conservación* n. 0–2009, 2009, pp. 35–44.
- [7] Fabbri K. “The Study of Historic Indoor Microclimate”, pp.85–117, in Pretelli M., Fabbri K. *Historic Indoor Microclimate of the Heritage Buildings. A Guideline for Professionals who care for Heritage Buildings*, Springer, 2018.
- [8] Fabbri K., Pretelli M., *Heritage buildings and historic microclimate without HVAC technology: Malatestiana library in Cesena, Italy*, *UNESCO memory of the World, Energy and Building*, V.76, 2014, pp. 15–31.
- [9] Fabbri K., Pretelli M. *Historic Indoor Microclimate (HIM): a new challenge in heritage building*. In: *Heritage 2016, Proceeding of the 5th International Conference on Heritage and Sustainable Development Volume 2*. LISBOA, 2016.
- [10] Pretelli M., Fabbri K. (2018) *Historic Indoor Microclimate of the Heritage Buildings. A Guideline for Professionals who care for Heritage Buildings*, Springer, 2018.
- [11] Beltramini G., Burns H. *Palladio*, Marsilio, Venice, 2008.
- [12] IESVE Software, website, <https://www.iesve.com/> (accessed 4/1/2018).
- [13] Palladio A. *I Quattro Libri dell'Architettura*, 1570 at link: https://www.liberliber.it/mediateca/libri/p/palladio/i_quattro_libri_dell_architettura/pdf/palladio_i_quattro_libri_dell_a.pdf (accessed 08.02.2018)
- [14] CISA (1958) research institute of architectural history, founded in 1958. Website online www.palladiomuseum.org (Copyright).
- [15] UNI 10829 *Works of art of historical importance. Ambient conditions for the conservation. Measurement and analysis*, 1999.
- [16] MIBACT Ministerial Decree, *Atto di indirizzo sui criteri tecnico-scientifici e sugli standard di funzionamento e sviluppo dei musei*, 10th May 2001).

An unfair reputation

The energy performance of mid-century metal-and-glass curtain walls

D. Artigas¹, S. O'Brien¹ and A. Aijazi²

¹ Building Technology, Simpson Gumpertz & Heger Inc., (SGH), New York, NY, USA.
Email: djartigas@sgh.com; smobrien@sgh.com

² Center for the Built Environment, University of California at Berkeley, (UC Berkeley), Berkeley, CA, USA. Email: arfa@berkeley.edu

Abstract – The common argument that mid-century Modernist buildings with single-glazed, non-thermally-broken curtain wall systems are less energy efficient than modern buildings, often is used to justify demolishing these buildings or significantly altering their façades, many of which are significant examples of historic Modernist architecture. This belief does not consider the effect that the ratio of building enclosure area to volume has on energy use, nor does it consider the often poor efficiency of the existing older mechanical equipment's effect on the overall energy profile. In some cases, the performance of the curtain wall contributes less to the overall building energy performance than heating/cooling, ventilation, and lighting. This paper presents an exploration of the energy use of historic curtain wall systems for two types of buildings and the return-on-investment (ROI) and effect on overall energy use of replacing/altering the curtain wall versus upgrading the mechanical systems.

Keywords – curtain wall; energy; Modernism; mechanical systems

1. INTRODUCTION

1.1 ENERGY CONSUMPTION AND COSTS

A building's energy gain or loss (load) through the building envelope is a function of many things, including the envelope's thermal performance characteristics, solar heat gain coefficients, interior and exterior climate, air leakage, the orientation of the façade, etc. Many mid-century curtain wall buildings (Figure 1 is an example) are taller buildings with relatively large floor plates.

Previous research shows that as a building's surface area-to-volume ratio decreases, the contribution of the envelope load to the total building energy use also decreases, particularly for heating in colder climates.[1] In these cases, other loads, such as mechanical systems and lighting can have a much greater impact on the building's energy profile, though lower envelope loads will lead to lower energy use for the mechanical system.

The United States (US) Department of Energy's (DOE) 2011 Buildings Energy Data Book [2] provides analysis of overall US building energy consumption by end use. This data is not separated by building type, envelope, function, age, or location, but it is useful in that it shows that 50 % of US building energy use goes

to mechanical systems (heating, cooling, and ventilation) and 9 % goes to lighting.

Other data published by the DOE [2] compares older buildings to contemporary buildings. For office buildings, which often have metal-and-glass curtain wall systems, the average energy use intensity (EUI) for buildings from pre-1959 through 1969 was 225 to 238 kWh/m²/yr (71.4 to 75.5 kBtu/ft²/yr), whereas the EUI for buildings constructed in 2000 through 2009 was 257 kWh/m²/yr (81.4 kBtu/ft²/yr). Also, the energy cost in 2009 for office buildings constructed from pre-1959 to 1969 was €37/m² (\$2.5/ft²)[2,3], whereas the energy cost for buildings constructed in 2000 through 2009 was €32/m² (\$2.1/ft²).[2,3] This data is not separated by building type, size, or location, but the available published energy consumption and cost data generally does not support the notion that newer must be more efficient or that older buildings will have higher energy costs than contemporary buildings. Instead, this data shows that the energy performance of older and newer office buildings is roughly equal.

We often consider a building's site or end use energy consumption when discussing the global impact of building energy use, as it intuitively makes sense that lower site energy consumption must be better for the environment. However, considering energy in this way neglects the energy used to extract, process, transport, and transmit energy to the building (source energy). For example, natural gas can have extraction/piping losses of around 5 % to 10 %, as compared to electricity, which can have generation/transmission losses of up to 70 %. These efficiencies affect the pricing of energy for the consumer, who pays for the raw source energy as well as for what is available to the building for use by the time it is delivered. Therefore, the building's energy cost is a better indicator of the building's energy impact on the environment. For this reason, site energy cost is used as the basis for comparison in most energy codes in the US. Since the efficiency of electricity will vary by generation type (e.g., a hydroelectric plant vs. a coal-fired power plant), using local energy cost data helps evaluate energy issues. However, note that the correlation between source energy and energy costs are not always direct, as energy costs also will be affected by generation type, demand schedules, market forces, government subsidies, regulations, etc. Also, building owners and managers likely will make their decisions for building improvements more on the building's operational energy costs than on source



Figure 1. Example of mid-century Modernist curtain wall building (Seagram Building, New York, NY. Architects: Ludwig Mies van der Rohe and Philip Johnson). Photo: Wikipedia, open source.

energy, as they are often concerned with the “payback period” on such upgrades. Consequently, we consider energy costs to be the main practical consideration in this type of analysis and use those metrics in our analysis. However, as discussed above, we also expect that the magnitude of changes in energy costs will be similar in magnitude to changes in source energy used, making energy costs a proxy for source energy use for the purposes of this study.

2. ENERGY MODELLING

2.1 ENERGY MODELLING APPROACH

One useful tool for evaluating ways to improve the energy performance of an existing curtain wall building (or any building) is whole-building energy analysis/energy modelling. Modelling can quantify the benefits of improvements to the building envelope, mechanical systems, and lighting systems in terms of the building’s energy consumption and energy costs. For all cases, it is important to note that the results of an energy model should not be seen as a prediction of actual future energy use for a building, but rather as an order of magnitude indicator of the change in performance associated with different building modifications.

To evaluate the changes to the energy performance from different modifications to mid-century curtain wall buildings, we created energy models of two different buildings: a four-story building and a twenty-story building. This exercise was theoretical to test assumptions and potential for energy improvements, rather than an analysis of specific existing buildings. The objective of our analysis was to evaluate the relative change in energy performance and cost from incremental improvements to the building envelope and mechanical systems. As a point of comparison, we also modelled a contemporary curtain wall building with modern systems, IGUs, and thermally broken aluminium framing. We do not consider analysis of these two building types to be representative of all mid-century curtain wall buildings; our purpose here is to test assumptions and provide a framework for analysing a mid-century curtain wall building’s energy profile that could be applied to other cases.

We used the DesignBuilder Version 3.2.0.067 and EnergyPlus Version 7.2.0.006 computer programs to calculate the total annual energy use for the two building types, including building enclosure, lighting, plug, and mechanical system loads. EnergyPlus is a whole-building energy simulation program developed and validated (using standards from the American Society of Heating, Refrigerating and Air-Conditioning Engineers (ASHRAE), American National Standards Institute (ANSI), and the International Energy Agency (IEA) by the US DOE that simulates and analyses energy consumption in buildings.

This study examines building performance in New York City using annual hourly weather data from John F. Kennedy International Airport from the US DOE.

[4] For energy cost analysis, we used annual average commercial retail prices for electricity and natural gas rates in New York State from the US Energy Information Administration’s State Energy Data System.[5] We selected New York

City as the location for this study because it has a high volume of mid-century curtain wall office buildings and because it is in a climate that experiences all four seasons and a wide range of environmental conditions, including cold winters and warm humid summers. Note that buildings in different climates or in locations that have less urban density may have different results than those presented here.

We assumed internal gains for a typical office building. We kept occupancy rates and schedules, lighting, and plug and other loads constant for all cases to mitigate their effect on the relative change in energy performance between cases.

The modelled four-story building is mid-block with lot line walls, i.e., adjacent buildings on two sides, which often occurs in dense urban areas, such as New York City. The model includes shading on the sides (east and west facing elevations) and solar exposure on the front and back (north and south facing elevations). To be conservative, we assumed still exterior air conditions at the lot line walls, representative of a large gap between the adjacent buildings.

The modelled twenty-story building is standalone, i.e., no adjacent buildings to any side, so the model includes solar exposure on all four sides. While taller buildings, even in dense urban areas, typically will have at least some exposure on all elevations, they also will experience a great variety of shading from adjacent buildings or may share a lot line wall for part of their height. Rather than attempt to address the almost infinite variety of shading or lot line wall possibilities, we simplified the models by omitting shading and lot line walls for this case solely for comparison purposes.

In Table 1 we list the building component characteristics that varied between models. We based building envelope values on our experience with mid-century curtain wall and contemporary curtain wall buildings, and on typical US energy

Table 1. Energy Modelling Input Data

Building Component / Characteristic	Baseline	Improved Performance (New construction cases include all upgraded performance characteristics)
<i>Roof</i>	U-factor: 0.568 W/(m ² -K) 0.100 Btu/(ft ² -hr-°F)	U-factor: 0.284 W/(m ² -K) 0.050 Btu/(ft ² -hr-°F)
<i>Lot Line Walls (only appears in four story building)</i>	Type: Uninsulated three-wythe brick U-factor: 1.19 W/(m ² -K) 0.209 Btu/(ft ² -hr-°F)	Type: Insulated three-wythe thick brick U-factor: 0.590 W/(m ² -K) 0.104 Btu/(ft ² -hr-°F)
<i>Glazing</i>	U-factor: 5.837 W/(m ² -K) 1.028 Btu/(ft ² -hr-°F) SHGC: 0.76 (single-glazed, 3 mm (1/8 in.) clear glass)	U-factor: 2.3 W/(m ² -K) 0.50 Btu/(ft ² -hr-°F) SHGC: 0.40 (code-compliant dual-glazed insulating glazing system, based on 2011 New York City Energy Conservation Code)
<i>Central Chiller</i>	COP: 1 (assuming steam absorption chiller, common in historic buildings)	COP: 5.5 (modern electric chiller)
<i>Boiler</i>	75 % thermal efficiency (steam)	90 % thermal efficiency (hot water)
<i>Air Handlers</i>	90 % fan motor efficiency	95 % fan motor efficiency

code requirements for new buildings. We modelled a mechanical system with a central steam absorption chiller plant, a central steam boiler plant; constant volume forced air ventilation and cooling, and steam radiators and forced air in each zone.

2.2 FOUR-STORY BUILDING

As stated above, the four-story case is a mid-block building with lot line walls on its east and west elevations. Our analysis showed that the baseline four-story historic curtain wall building had a simulated EUI of 463 kWh/m²/yr (147 kBtu/ft²/yr), which is in general agreement with data published by the Lawrence Berkeley National Laboratory (LBNL) for older office buildings in the US.[6] The majority of the energy consumption was for heating at 59 %, with 14 % for cooling and 9 % each for lighting and ventilation (Figure 2). However, the energy cost results (using the New York State energy cost data cited above) showed that cooling had the highest percentage cost at 26 %, despite its relatively low contribution to overall energy consumption for the building (on a site energy basis), with 20 % for heating and 18 % each for lighting and ventilation (Figure 3). The systems that use electricity (cooling, lighting, and ventilation) have higher energy cost due to energy losses from generation and transmission – exemplifying the need to look at source energy use and energy costs when evaluating global impacts from building energy use.

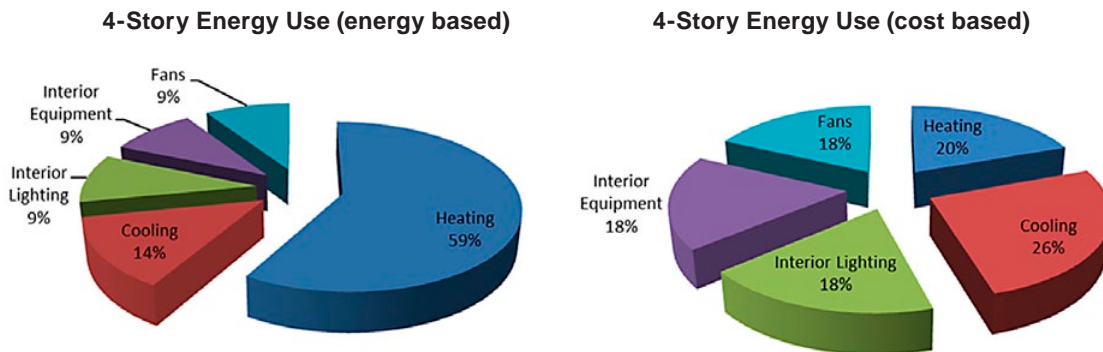

Figures 2 and 3. Site Energy Consumption and Site Energy Costs Results for the Four-Story Building.

We reviewed a progression of upgrades to the building and its mechanical equipment, which we list in order here (Figure 4):

- Replacing the chiller with a modern electric chiller reduced the annual energy (operating) cost for the building by approximately 45 %.
- Adding insulation to the lot line walls and roof had negligible effect.
- Replacing the steam boiler and radiator system with a modern efficient hot water system and installing new fan motors reduced the energy cost by approximately 7 %.
- Replacing the historic curtain wall with a new thermally-broken and IGU system, but maintaining the existing boiler and fans, reduced the energy cost by approximately 15 %.

Annual Energy Cost for 4-Story Modifications

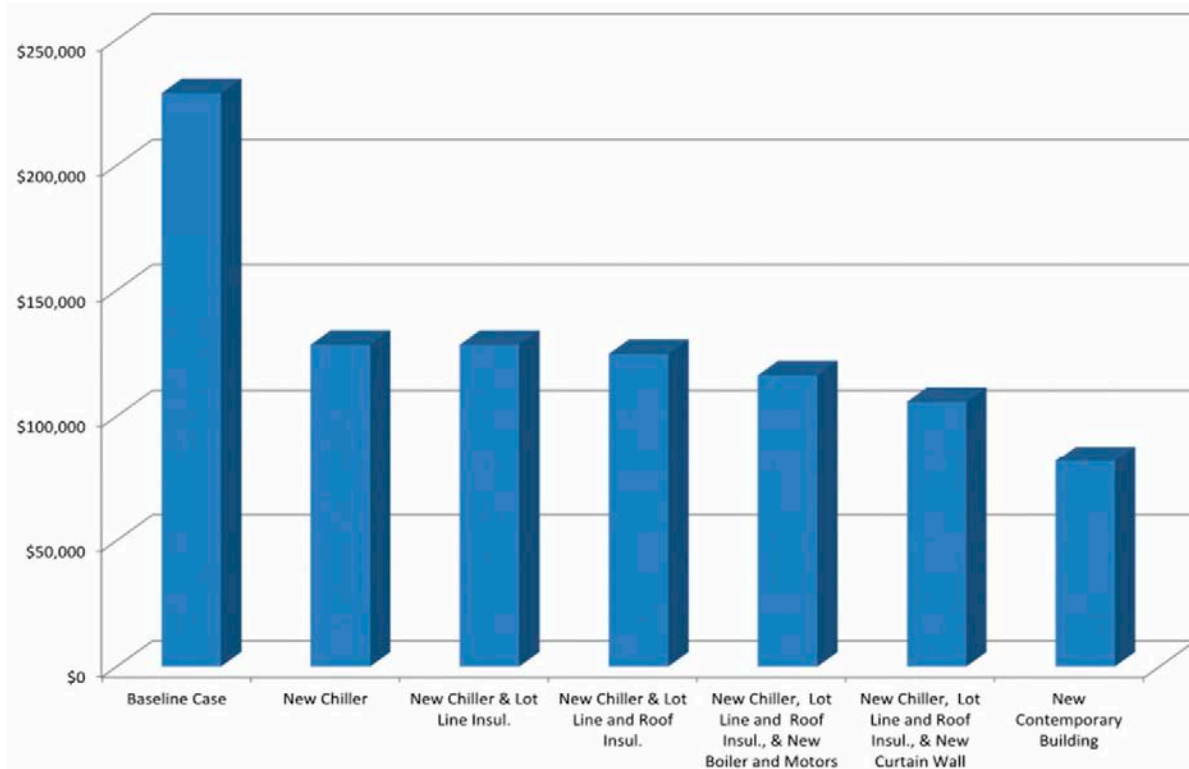

Figure 4. Effects of Upgrades to Building and Systems on Energy Costs for the Four-Story Building.

The models showed that, for the four-story building, replacing the chiller with a modern chiller significantly can reduce the energy profile of the building, and has the greatest effect on the energy costs. As a point of comparison, the models show a new curtain wall building as having energy costs 36 % lower than replacing the chiller only in an existing building. However, in terms of construction costs and the energy required to demolish the existing and manufacture and construct a new building, replacing a chiller would have a much lower initial cost (while published data for chiller replacement is difficult to find, we have found sources indicating a cost of around \$250,000 to \$400,000 for a 1930 to 2280 kW (550 to 650 ton) chiller replacement [7,8,9], a much more immediate ROI, and an arguably much lower overall impact on the environment than demolishing the existing building and replacing with new. Other incremental improvements could further reduce the energy cost of the existing building but, considering the reduction in costs ranges from almost nothing to 7 %, we expect that the relative effort to implement these improvements (such as replacing a boiler and radiator system) would have a much longer ROI for these cases.

The models also showed that replacing the existing curtain wall with new would have relatively low effect on the building's energy profile after replacing the chiller (by a factor of one-third). Based on our project experience, we estimate a cost of \$2200/m² to replace an existing curtain wall with a manufacturer's standard system, not counting the operational costs due to tenant and building disruption. For an approximate 372 m² (4000 ft²) curtain wall area, the cost of replacing the curtain wall (approximately \$800,000) is around two to three times that of

replacing the chiller, at one-third the reduction in energy costs (after replacing the chiller). And, we would expect that replacing the curtain wall would have a far greater impact on the environment (in terms of materials and embodied energy), not to mention the loss of historic fabric that is a main contributor to the building's architectural significance and integrity.

Note that we expect these results would change in different climates or with different exposure or use for the building. However, these results show that a more in-depth analysis of an existing low-rise mid-century curtain wall building is warranted when assessing its energy performance, rather than just assuming that these buildings have irredeemably high energy consumption.

2.3 TWENTY-STORY BUILDING

As stated above, the twenty-story case is a standalone building, considering that taller buildings, even in dense urban areas, often have some exposure on all four sides. Our analysis showed that the baseline twenty-story historic curtain wall building had an EUI of 473 kWh/m²/yr (150 kBtu/ft²/yr), which again is in line with the data published by the LBNL for buildings in the US. [6] The majority of the energy consumption was for cooling at 59 %, with 14 % for ventilation, 10 % for lighting, and 8 % for heating (Figure 5). As noted earlier, as the building's surface area-to-volume ratio decreases (compared to a shorter building), the contribution of heating to total load also decreases particularly in colder climates. The energy costs (using the New York State energy cost data cited above) follow the energy consumption for this case, with 64 % for cooling, 15 % for ventilation, 10 % for lighting, and only 1 % for heating (Figure 6), which is logical because the systems that use electricity (which has relatively high cost in New York) also have higher energy consumption.

We reviewed upgrades to the building and its equipment, which we list in order here (Figure 7):

- Replacing the curtain wall with a new thermally broken and insulated glazing system reduced the energy cost for the building by approximately 23 %.
- Replacing the chiller with a modern electric chiller, but maintaining the existing curtain wall, reduced the annual energy cost for the building by approximately 47 %.

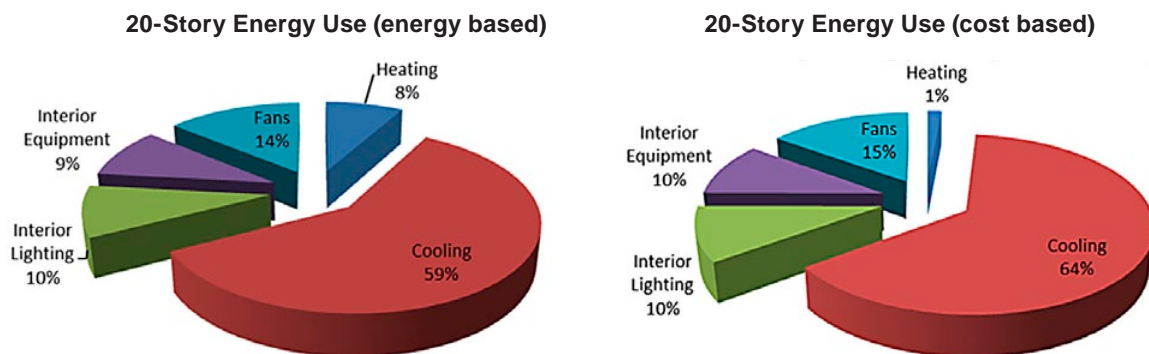

Figures 5 and 6. Site Energy Consumption and Site Energy Costs Results for the Twenty-Story Building.

The models show that replacing the chiller alone can reduce the energy cost almost by half and that it has a much greater effect on the building's energy profile than replacing the curtain wall, and likely at much lower cost and impact on the environment. Again, published data for chiller replacement is difficult to find, but we have found sources indicating a cost of around \$1.3 to \$2 million to replace chillers with a capacity of around 8800 kW (2500 tons).[7,8,9] By comparison, estimating \$2200/m² to replace the curtain wall, for an approximate 7432 m² (80,000 ft²) curtain wall replacement, the cost would be approximately \$16 million (again, not including the costs of tenant disruption for an occupied building). While the 23 % savings in energy cost from replacing the curtain wall is significant, it is half of the savings that would come from replacing the chiller but at approximately four times the cost, and it results in the destruction of historic fabric that typically is one of the main contributors to the building's historic significance. Due to the small energy cost and use associated with heating, we did not model cases with a new boiler as there would be very low ROI and little reduction in energy use or cost.

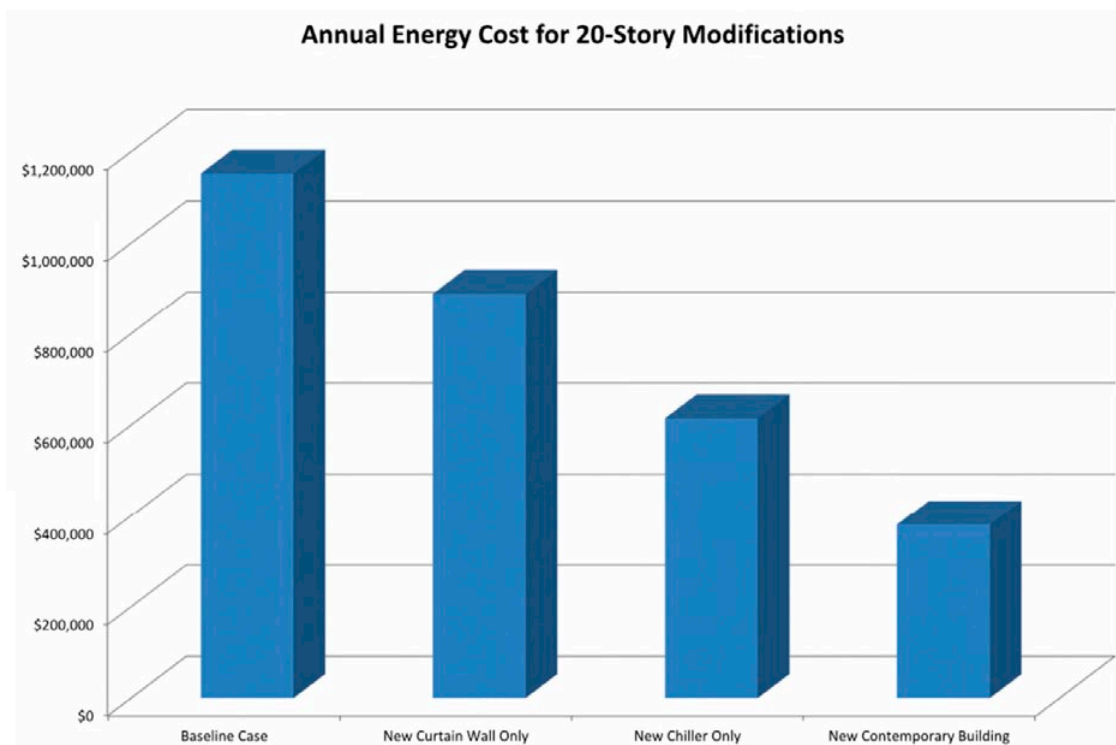

Figure 7. Effects of Upgrades to Building and Systems on Energy Costs for the Twenty-Story Building.

Again, when comparing upgrades to the existing building to a new building, a new building would have energy cost 38 % lower than replacing the chiller only, but at a much higher initial cost and we expect a far greater impact on the environment.

Similar to the four-story case, we would expect these results to change with different exposure and in different climates. But, as with the four-story case, these results again show that assumptions about the poor energy performance of mid-century curtain wall buildings may not be founded in fact and that more rigorous analysis is warranted for any individual building.

3. CONCLUSIONS

The tendency to replace historic curtain wall systems with contemporary systems can be misguided in the absence of testing and analysis of the building. For the types of buildings in climates similar to those analysed here, replacement of single-glazed historic systems with thermally-broken contemporary aluminium-framed systems with IGUs likely will not result in as significant an ROI as other potential building improvements, though the results do show improvement in the buildings' energy use and costs. While the demand on the mechanical system will depend in part on the thermal and air leakage performance of the envelope (and a better-performing envelope will lead to lower demand on the mechanical systems), in the cases modelled here, the older mechanical systems' efficiencies contribute far more to the existing buildings' energy use and cost than the curtain wall itself, and the taller the building the less effect the curtain wall has on the building's energy profile. Building systems that require electricity have the greatest effect on the building's energy cost and the environment due to the transmission losses involved in delivering the electricity to the site in these models. The greatest ROI in these cases, in terms of cost, is to replace older cooling equipment with modern, more efficient equipment. Note that this study was limited to two building types in one location and that local market forces, regulations, and energy sources will affect the costs of electricity, and the results of this type of modelling will vary depending on the location, exposure, and specific building systems. However, the results of this analysis demonstrate the potential dependence of energy use on a multitude of factors that are independent of the façade of the building, and the need for each building to be assessed on an individual basis.

Mid-century Modernist curtain wall buildings present a new type of challenge to the preservation community due to the scale and repetitive nature of their façades, and we consider the approach presented here to be valuable when assessing the energy performance of these types of buildings, both to assess the potential ROI of different improvements to the building, and potentially to help protect these buildings from the quick judgement that older is worse and cannot be improved, while newer is always better. Replacing the curtain wall with new would destroy the historic fabric that contributes to the building's architectural significance, may have much lower ROI than other potential improvements that would not affect the contributing historic fabric, and possibly have a worse environmental impact.

4. REFERENCES

- [1] P. Oldfield, D. Trabucco and A. Wood. "Five Generations of Tall Buildings: An Historical Analysis of Energy Consumption in High Rise Buildings," *The Journal of Architecture* vol. 14 (5), pp. 591–613, 2009.
- [2] US Department of Energy. (2012, March) 2011 Buildings Energy Data Book. [Book]. Available: <http://buildingsdatabook.eere.energy.gov> [30 July 2014]. Note, data in the original are in English units and US dollars. We converted to metric units and Euros for this article.

- [3] Currency conversions are approximate in 2009 Euros according to: Internet: www.xe.com/currencytables/?from=USD&date=2009-05-12 for May 2009 [17 May 2018].
- [4] US Department of Energy. "Weather Data for New York-J F Kennedy Intl AP." Internet: http://apps1.eere.energy.gov/buildings/energyplus/weatherdata_about.cfm [October 2014].
- [5] US Energy Information Administration. "U.S. States State Profiles and Energy Estimates." Internet: <http://www.eia.gov/state/seds/> [October 2014].
- [6] Lawrence Berkeley National Laboratory. "Building Performance Database." Internet: <https://bpd.lbl.gov/> [October 2014]. Note, data in the original are in English units. We converted to metric units for this article.
- [7] C.W. Sohn and K.O. Homan. "USACERL Technical Report FE 94/07: Estimated Retrofit and Replacement Costs for Army Air-Conditioning and Refrigeration Equipment Presently Using Chlorofluorocarbons." US Army Corps of Engineers Construction Engineering Research Laboratories, March 1994. Note, we adjusted costs data presented in this document for inflation to 2018 US dollars.
- [8] R. Allender. "Chiller Replacement Project; How the Grand Hyatt Singapore Applied a Holistic Commercial View," Hotel Online, October 2003. Internet: https://www.hotel-online.com/News/PR2003_4th/Oct03_ChillerReplacement.html [May 2018].
- [9] "Chillers: Compare Installation Costs." Internet: <http://www.alabamapower.com/business/ways-to-save/chillers-space-cooling-options/compare-installation-costs.html> [May 2018].

Energy efficiency and preservation of 20th century architecture

The case of the Urbino University Colleges

D. Del Curto¹, C.M. Joppolo¹, A. Luciani² and L.P. Valisi¹

¹ *Climate and Energy for Cultural Heritage Laboratory, Politecnico di Milano, Milano, Italy. Email: davide.delcurto@polimi.it; cesare.joppolo@polimi.it; luca.valisi@polimi.it*

² *Department of Civil, Environmental and Natural Resources Engineering, Luleå Tekniska Universitet, Luleå, Sweden. Email: andrea.luciani@ltu.se*

Abstract – This paper follows the discussion on the energy efficiency of heritage buildings by dealing with the task of preserving 20th century buildings and making them more sustainable. It is confirmed that a thorough analysis of each case is needed, since the cultural value of modern heritage risks being overwhelmed by the effort to improve its energy efficiency. The Urbino University Colleges are a masterpiece of the 20th century. They were designed by architect Giancarlo de Carlo, built between 1962 and 1983 and still host 1000 students. A conservation plan was outlined in 2016 with the aim of developing the long-term and sustainable preservation of such a huge complex. A specific goal in terms of sustainability was lowering the heating costs to save funds for conservation activities. The efforts were thus to balance building conservation, energy efficiency and users' comfort. A thermal analysis, an energy retrofit design, a test on a pilot site, a comparison between before and after, are the tools that have been used to achieve this objective. Results provide some operational indications to merge conservation and sustainability in a 20th century heritage building.

Keywords – monitoring, energy retrofitting, building-plant design, 20th century architecture, pilot site

1. INTRODUCTION

1.1 THE URBINO UNIVERSITY COLLEGES

The Urbino University Colleges were built between 1962 and 1983 on the Cappuccini Hill, approximately 1.5 km from the Renaissance city. They were designed by architect Giancarlo De Carlo (1919–2005) as a part of an overall strategy of urban development, promoted by Carlo Bo, at that time Rector of the University. The five buildings, namely “Colle”, “Tridente”, “Serpentine”, “Aquilone” and “Vela”, are equipped with 975 rooms that can accommodate up to 1136 people (net usable area = 32,396 m², gross heated volume = 127,059 m³). The residential units consist of single and double rooms, with personal or shared toilets and kitchens. Public spaces, such as reception, canteens, dining rooms, conference and meeting rooms, classrooms, offices, technical rooms and a theater, are located in the central body of each college. The general layout follows the contours of the landscape, branching and distributing the buildings from the Cappuccini Hill to the valley [1].

The load bearing facing brick walls and the exposed concrete beams and slabs are not insulated, just as many other buildings inspired by the “New Brutalism”. The original windows are mainly of two kinds: timber frame windows with single glazed glass, and iron-framed skylights with a simple glazed panel. Many original windows have already been replaced with different types of new windows. There are many issues concerning the conservation of these buildings: decay of the reinforced concrete, poor waterproofing and leakage through the roofs, decay and faults in tightness of windows and doors, compliance with laws and regulations for safety and fire prevention, limited or lacking maintenance.

As regards the HVAC systems, the original power station was renewed in 2012: three pressurized boilers with a rated output of 1650 kW each, reverse flame, three burners with 2 stage progressive/modulating, a CHP (electrical power 637 kWel, thermal power 770 kW, thermal power introduced 1620 kWth), different systems of storage of technical water, rapid heat exchangers of modules for the production of sanitary hot water, solenoid valves, plate-fin heat exchangers. A grid connected photovoltaic system (270 panels, 81 kW peak power) was then installed on the roof of the “Tridente” building. The district’s heating circuit consists of a basement distribution ring with substations. The heat emitting subsystem consists in cast iron radiators at high temperature.

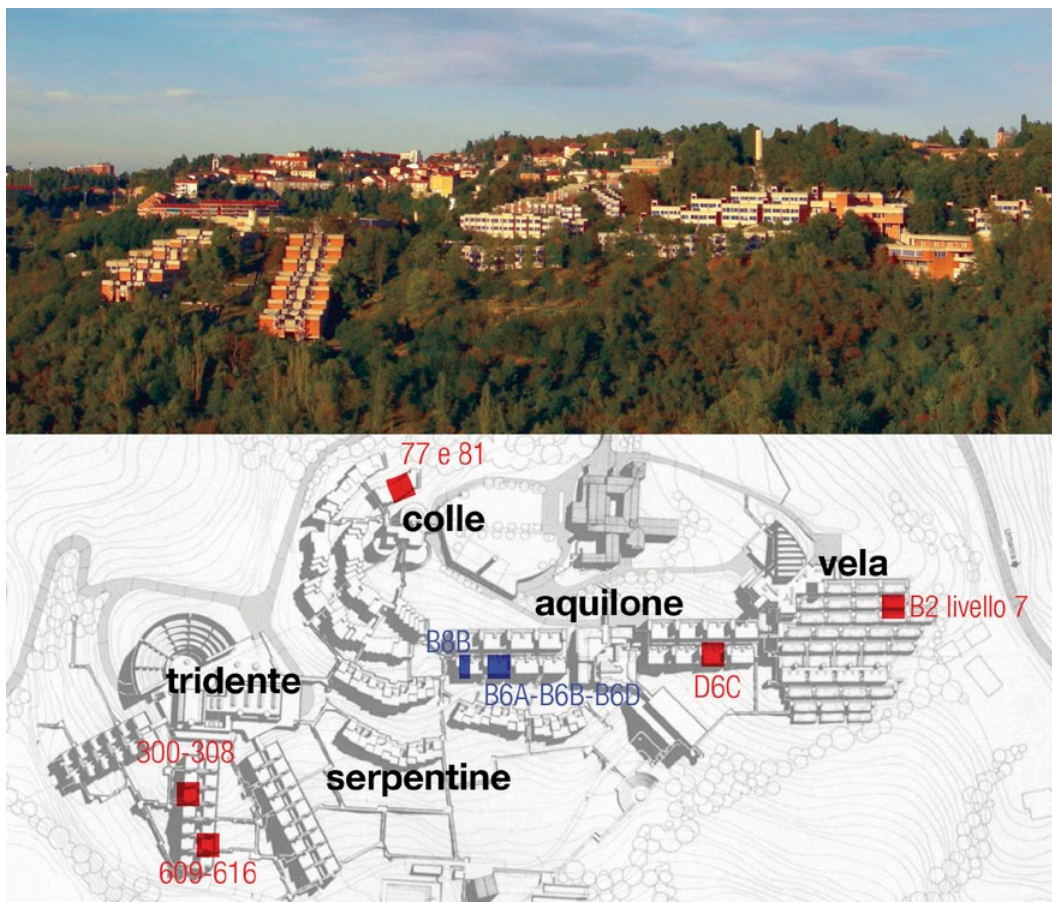

Figure 1. General plan: position of the rooms continuously (blue) and seasonally (red) analysed.

2. INDOOR CLIMATE MONITORING

The indoor climate was monitored to assess whether the heating system complied with its set points or not, and to locate the areas where local imbalances affected the comfort. The analysis was also helpful to detect if such imbalances were due to the type of heating system, to a faulty installation or to a lack in the control system. The authors monitored surface temperatures, indoor and outdoor air temperature and humidity throughout a whole year (12/2015–12/2016). Although surveys were seasonally repeated within all the colleges (Figure 1), the monitoring system was only set in the “Aquilone” building and specifically in two couples of bedrooms and a common area, which displayed the most typical layouts of the complex. Sensors were installed

- in a couple of overlapping rooms located on different floors (rooms B6B and B6D), still retaining their original windows;
- in room B8B, which is situated in a similar position but has a new aluminum frame without thermal break;
- in room B6A, which is representative of the rooms without a cold wall (Figure 2,3).

Ten sensors monitored temperature (T [°C], accuracy: $\pm 0,1$ °C at -25 °C/ $+80$ °C) and relative humidity (RH [%], ± 2 % at 0 %/100 %); four of them also measured surface temperature (T_{sup} [°C]). A total of twenty-two measuring points were thus operative and wireless-connected (UNI EN 15758:2010, UNI EN 16242:2012). An infrared camera was used to detect heat losses, thermal bridges and heat gains due to solar radiation (accuracy ± 2 °C at -40 °C/ $+500$ °C, 640x480 pixels, 40mK at 30 °C). Temperature and relative humidity distribution were mapped by means of a digital psychrometer (accuracy 0.1 °C, resolution 0,01 °C) patented by Politecnico di Milano [2]. Data have been processed according to UNI 10829:1999. Maximum, minimum, average, and standard deviation, daily and annual temperature range, time profiles, frequency distribution and cumulative frequency were determined for each parameter. The information resulting from



Figure 2. Position of the monitored rooms on the SW façade of the “Aquilone” building.

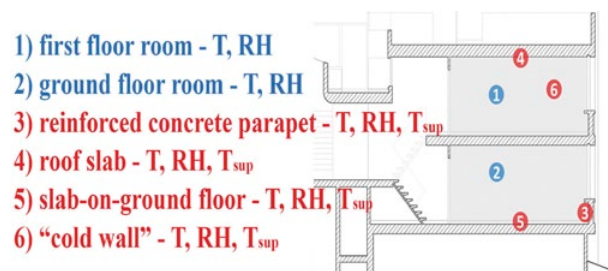

Figure 3. Position of the sensors along the cross section of the “Aquilone” building.

the monitoring of few rooms were extended to the whole complex by using a Performance Index, i.e. the percentage of time when parameters fall within an acceptable range.

For the winter season (01/12/2015 – 07/05/2016), two Failure Indexes were calculated:

- Cool Failure Index (% of time T_{iNdoor} falls below the lower limit of acceptability)
- Warm Failure Index (% of time T_{iNdoor} falls above the upper limit of acceptability).

Temperature ranges follow the heating set points. Relative humidity ranges follow UNI EN ISO 7730:2006 and ASHRAE 55 standards. Average daily temperature = $19\text{ }^{\circ}\text{C} \leq T_{av,day} \leq 21\text{ }^{\circ}\text{C}$; $18\text{ }^{\circ}\text{C} \leq T_{av,day} \leq 22\text{ }^{\circ}\text{C}$. Average daily RH = $40\text{ \%} \leq RH_{av,day} \leq 60\text{ \%}$; $30\text{ \%} \leq RH_{av,day} \leq 70\text{ \%}$.

A high percentage of Warm Failure Index resulted. Room B6a does not have a dispersing wall (Figure 4, right-side graph), so the high temperatures are due both to the possible over-heating and to the solar gains. The acceptability thresholds defined in the regulations are given by the need to protect the health of the occupants, considering their physiological reactions such as dry skin, irritation of the eyes and of the upper respiratory tract, and the need to prevent the proliferation of biological contaminants. All the sensors respected the RH acceptability intervals for 72 % of the days (considering a 40–60 % range) and for 96 % of the days (considering a 30–70 % range).

The average daily temperature was then compared to the average temperature calculated during the heating hours in order to verify whether they complied with the temperature set points. Temperature remained $< 20\text{ }^{\circ}\text{C}$ for 50 % of the days in the common areas that are directly connected with the outdoor environment. These large areas are only provided with few radiators placed along their perimeter, which is certainly not enough considering the huge volume that needs to be heated, the poor insulation and the lack of a temperature control system. Moreover, differently from the bedrooms, common areas do not benefit from free solar gains, due to the building orientation, nor from thermal gains due to the presence of people, as they are currently underused.

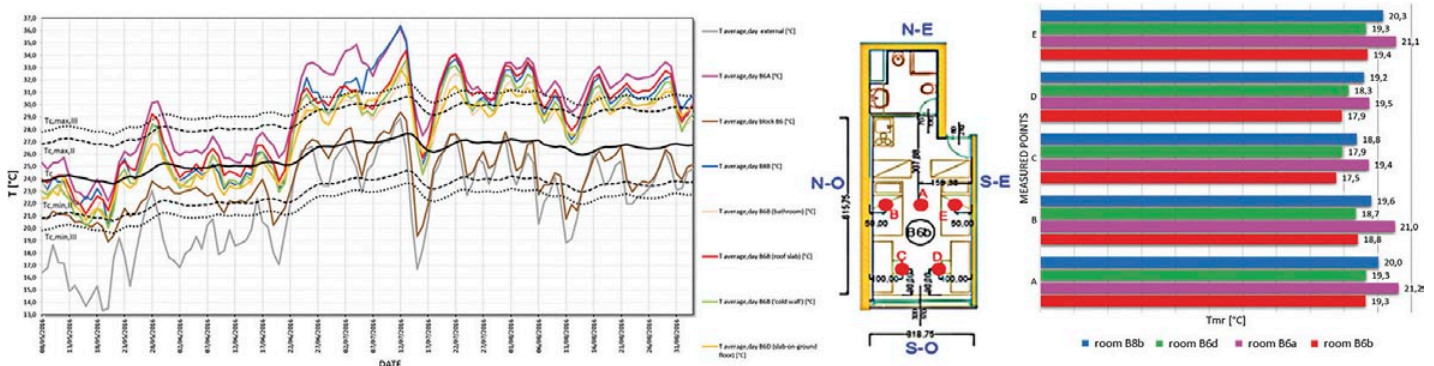
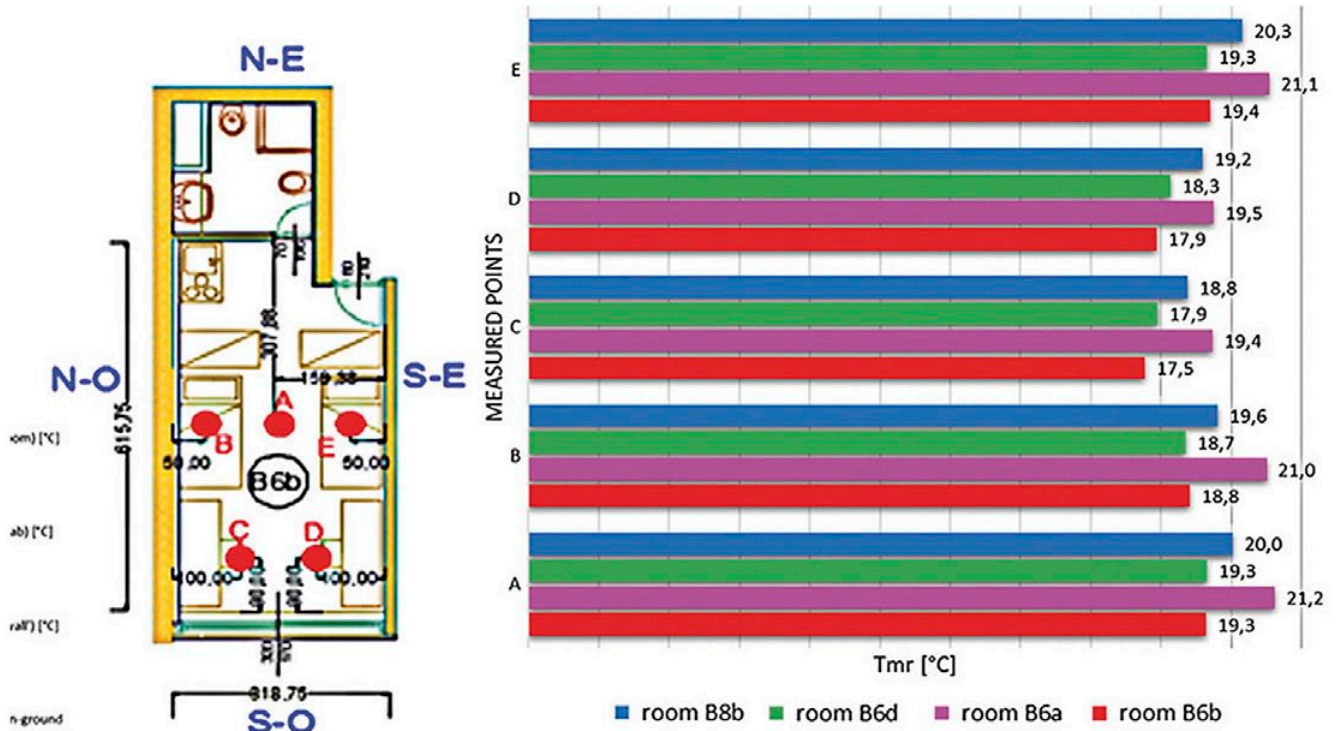
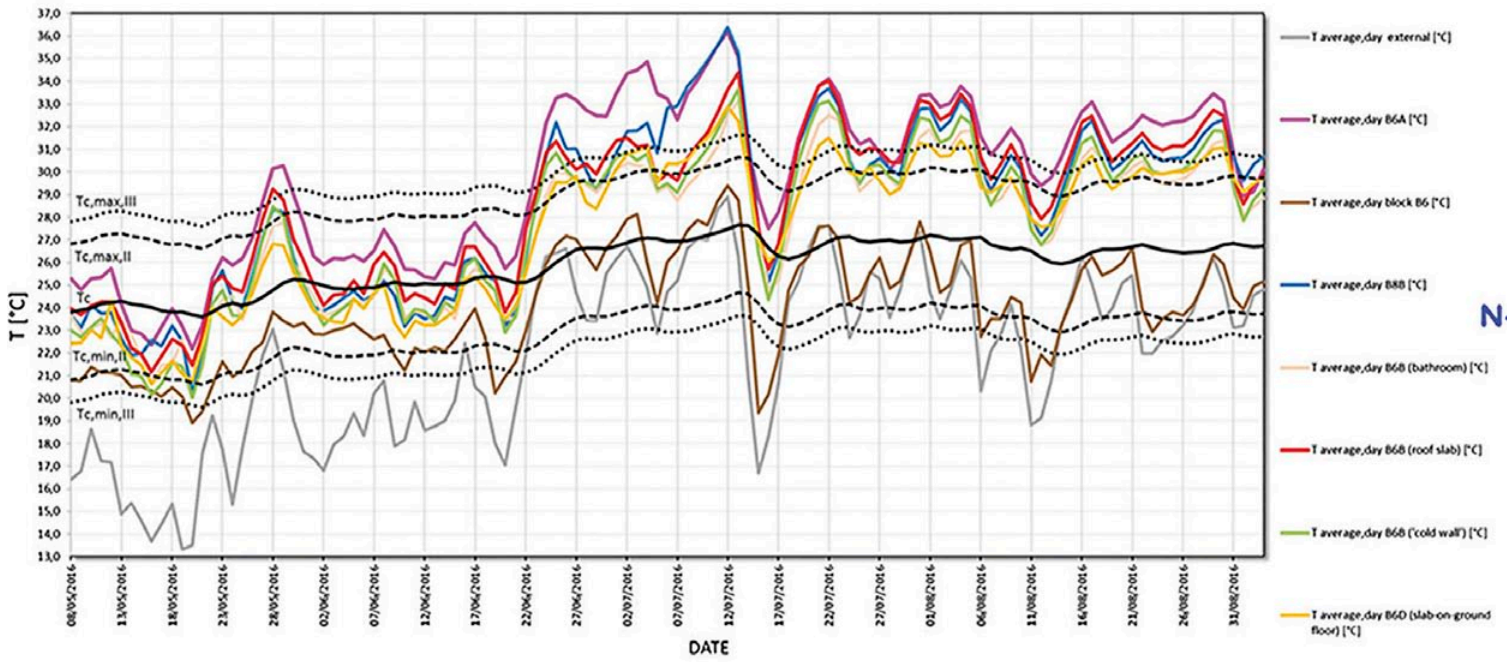

Figure 4. (See a close-up of this figure on the next page). Left: daily average air temperatures. Acceptance bands according to the adaptive method (8.5–31.8.2016). Right: mean radiant temperatures in the monitored rooms when the heating system is on.



(Figure 4. A close-up from the previous page)

Left (= above in this close-up): daily average air temperatures. Acceptance bands according to the adaptive method (8.5–31.8.2016). Right (= below in this close-up): mean radiant temperatures in the monitored rooms when the heating system is on.

An average of 20 °C was measured in all the bedrooms, although near the dispersant wall in room B6B, air temperature was < 20 °C for the 54 % of the days. This situation highlights a possible local discomfort. The hygrothermal comfort was then analyzed through the air operating temperature, which includes the linear average radiation temperature. In fact, a complete analysis must consider both the air temperature, and the local thermal discomfort.

The mean radiant temperature is obtained from five different points located in four rooms, through the calculation of the view factors (Figure 4b, left-side graph). We analyzed the most critical situation in winter conditions. We considered the air temperatures measured by all the sensors during the coldest weeks (01/12/2015–24/01/2016), making a distinction between the averages registered when the heating system was in operation (from 8 am to 10 pm) and the averages registered when the heating system was turned off (from 11 pm to 7 am). The air temperature in room B6B is 20.6 °C while the linear radiating temperature next to the dispersant wall (point C) is 17.5 °C, thus resulting in a 3.0 °C difference. During the nights, when the heating system is not operating, the temperature falls to 16.3 °C. Considering the average of the two, an operating temperature of 19.1 °C is obtained, thus resulting in discomfort by 1.5 °C. The discomfort was higher in proximity to the walls and to the windows characterized by poor thermal transmittance (5522 W/(m K)).

The local thermal comfort indices PMV (Predicted Mean Vote) and PPD (Predicted Percentage Dissatisfied) were calculated in a couple of critical points [3] by means of a software based on UNI EN ISO 7730:2006. The clothing thermal resistance was set to 1 clo (1 clo = 0.155 m²·K/W), as estimated for men's standard winter home clothing. The metabolic rate corresponding to the metabolic activity of a person sitting in an office (point C) is 1.1 met (1 met = 58.2 W/m²), while the established rate for a person sleeping (point B) is 0.8 met. Point C is the most uncomfortable when the heating system is on. Considering the case of a student sitting at a desk by the window during the day, the PMV is -0.99, thus exceeding the limits of acceptability by ± 0.5 according to UNI EN ISO 7730 and it thus corresponds to class C. The PPD expressing the feeling "very cold" results in 25.6 %. If we consider a student lying down on the bed at night (point B), the PMV is -2.85, which corresponds to a condition of absolute thermal discomfort. The PPD expressing the feeling "very cold" results in 98.2 %.

Thermography confirmed the thermal discomfort nearby the outer dispersant walls. The connection between the wall and the roof slab (17.5 °C < 20.8 °C) originates a thermal bridge, where temperature is 16.2 °C. Similar discomforts were detected in the "Colle" building, where a wall temperature of 12 °C was measured (room 83, March 25th at 10 a.m.). The air temperature near an outer wall (B6b, 23.5 °C) is lower than an inner room (B6a, 25.5 °C). Nearby the cold wall, a low air temperature results in a rise of specific humidity, due to the evaporation of leaked water. The same rooms were analyzed during summer, when the temperature of the inner side of the roof is 35 °C. Results also confirm the poor performance of the windows, which is a major issue to obtain stable conditions.

As regards to the summer season, (08/05/2016 – 15/10/2016) it must be considered that the building has no cooling system. A thermal adaptive comfort model (UNI EN 15251:2008) was therefore used to analyze the summer period. The adaptive model correlates the thermal sensation with the main climatic variables, thus taking into account the psychological wellbeing and the users' perception of the environment. The acceptability interval Class II represents a normal level of expectation and should be used for new buildings and renovations. The acceptability interval Class III represents an acceptable, moderate level of expectation and may be used for existing buildings. Both Class II and Class III have been verified. Figure 4, left-side graph shows the trends of daily average temperatures measured by all the sensors and the acceptance bands calculated according to the adaptive method. The thick black line represents the comfort temperature. The dashed black lines mark the Class II comfort range. The black dotted lines delimit the Class III comfort range. As a result, all bedrooms are overheated especially room B6a (magenta). The roof slab also gets overheated during summer because of solar radiation. The indoor air temperature is consequently very high, with a maximum (12/07/2016) of 41.3 °C in B8b room (blue), 39.6 °C in B6a (magenta) and 39.0 °C in B6b (red). High temperatures are also due to the poor insulation of the windows and to the lack of solar shading since the only shelter provided consists of indoor cotton curtains. These rooms are warm and dry, and such features affect the users' comfort (RH < 30 % for the 66 % of the days in room B6a).

3. ENERGY RETROFITTING

The building-HVAC system was studied by means of "MasterClima MC 11300 PRO" energy simulation software by AERMEC. Two blocks of rooms in the "Aquilone" building were analyzed, including bathrooms and common lounges (gross volumes of 14,143.70 m³, usable area of 3944.00 m²). The "Aquilone" building was used as a pilot site to test the building before and after the intervention. The model was validated by comparing the real consumption of methane with the temperature measured by the sensors. The simulation model applied to the original configuration allowed to calculate the thermal load in winter (585.85 kW) and summer conditions (377.66 kW). This early analysis highlighted the need of minimizing thermal bridges by means of insulating the walls and slabs, and of improving the performances of the windows, even considering a possible substitution. The roof slab resulted to be responsible for 12.3 % of the total dispersion and it thus needs to be improved, also considering the widespread problems related to water infiltrations.

Four scenarios for the insulation of walls and slabs were combined with three scenarios for the improvement of the windows, resulting in twelve scenarios to be compared (Figs. 5 and 6). The energy performance indexes, thermal and primary energy requirements and natural gas consumption were calculated for each scenario, together with the variations of thermal loads in winter and summer conditions. The best choice was made considering the combination of the winter and summer season, and taking into account the data obtained from the energy

simulations and the indoor climate monitoring. Due to the architectural relevance of the buildings, all the options were discussed among the different members of the project team, and especially among those responsible for the retrofitting design, and those in charge of the building maintenance and management. The aim of the team was to balance conservation issues, energy efficiency and

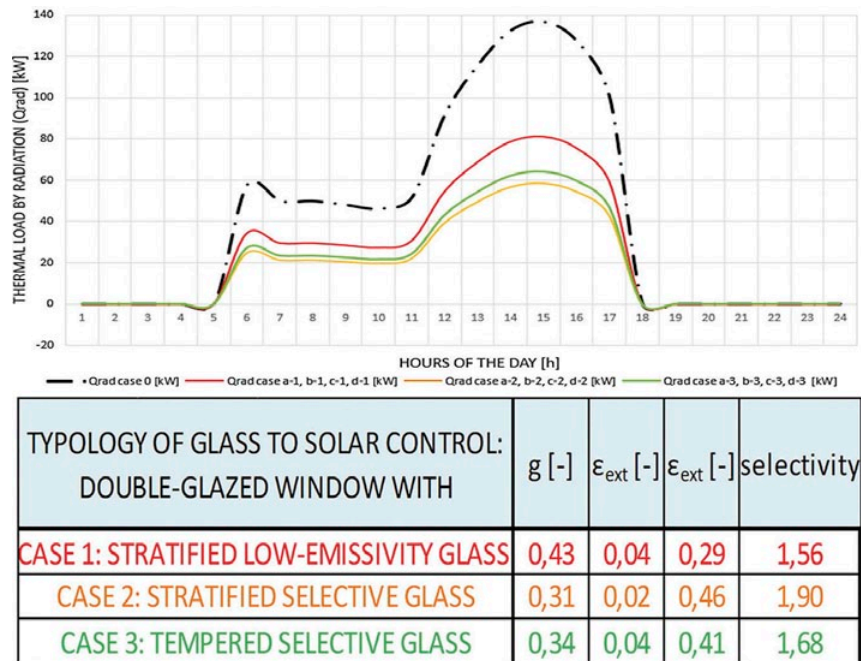

Figure 5. Thermal load by radiation in the windows before/after substituting the glass.

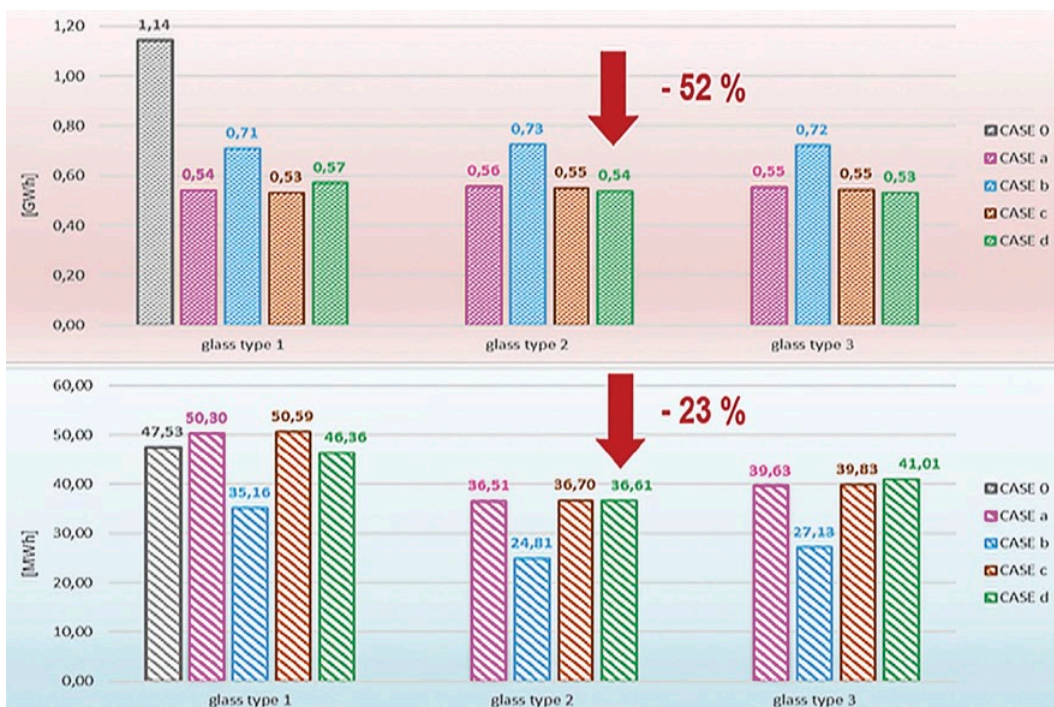

Figure 6. Energy demand for heating (top) and cooling (bottom). Present state vs 12 scenarios of retrofitting.

effectiveness in practical application. Any proposal had thus to cope with the architectural value of the Collegi. Insulating by external coating was therefore unacceptable, even if it would have contributed to solve several energy issues. Filling the wall with insulating materials was also not an option, since there is no cavity. As for the walls, internal insulation was thus considered the best choice.

A pilot site (12/2016–1/2017) implemented the best combination: scenario D (wall and roof slab) + scenario 2 (windows) in rooms B6a and B6b (Figure 7). However, during the pilot site some decisions were reconsidered. The concrete parapet on the top of the building could not be raised up and consequently, for safety reasons, the new slab insulation could not be thicker than 8 cm. An insulating panel was applied to the inner side of the perimeter wall but the panels had to be cut 20 cm before the window, in order to not have them visible from the outside. These limitations clearly resulted into weaknesses in terms of energy efficiency (Figure 8).

4 x 3 INSULATION SCENARIOS			
WALL/SLAB/ROOF		WINDOW	
A	FLAT ROOF: extrados layer (extruded polystyrene foam) - 8 cm	1	SLIDING ALUMINIUM WINDOW FRAME DOUBLE GLAZING STRATIFIED + LOW-EMISSIVITY GLASS
	PARAPET: indoor panel (mineral wool inside gypsum board) - 5 cm		ALUMINIUM BATHROOM SKYLIGHT DOUBLE GLAZING STRATIFIED - LAMINATED + LOW-EMISSIVITY GLASS
	EXTERNAL WALL: indoor panel (mineral wool inside gypsum board) - 5 cm		
B	FLAT ROOF: extrados layer (extruded polystyrene foam) - 8 cm	2	SLIDING ALUMINIUM WINDOW DOUBLE GLAZING STRATIFIED + SELECTIVE LAMINATED GLASS
	PARAPET: indoor panel (mineral wool inside gypsum board) - 5 cm		ALUMINIUM BATHROOM SKYLIGHT DOUBLE GLAZING STRATIFIED + SELECTIVE LAMINATED GLASS
	EXTERNAL WALL: not insulated		
C	FLAT ROOF: extrados layer (extruded polystyrene foam) - 12 cm	3	SLIDING ALUMINIUM WINDOW DOUBLE GLAZING + SELECTIVE TEMPERED GLASS
	PARAPET: indoor panel (mineral wool inside gypsum board) - 5 cm		ALUMINIUM BATHROOM SKYLIGHT DOUBLE GLAZING + SELECTIVE TEMPERED GLASS
	EXTERNAL WALL: indoor panel (mineral wool inside gypsum board) - 5 cm		
D	FLAT ROOF: inverted roof extrados layer (extruded polystyrene foam) - 12 cm		8 cm instead than 12 cm
	PARAPET: indoor panel (mineral wool inside gypsum board) - 5 cm		
	EXTERNAL WALL: indoor panel (mineral wool inside gypsum board) - 5 cm		Insulation ends 20 cm before the window

DISCARDED SOLUTION
ADOPTED SOLUTION
PILOT SITE CHANGES

Figure 7. Different scenarios for the insulation of wall, slab, roof and windows.



Figure 8. After the pilot site, from left to right: new window, “cold wall” insulation, slab cover.

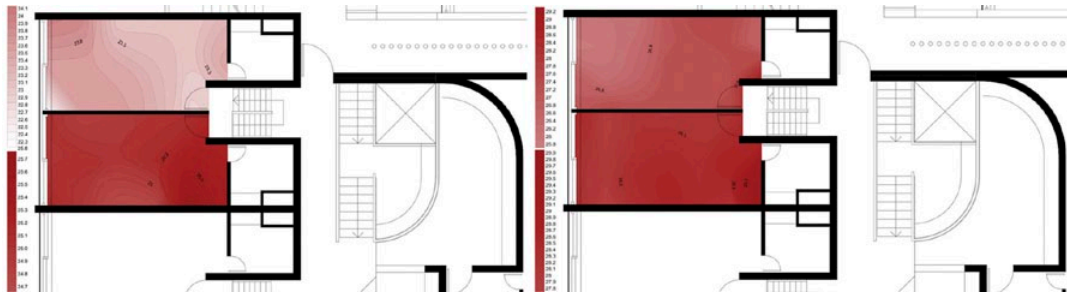

Figure 9. Temperature distribution before (left, 30.11.2015) and after (right, 22.2.2017) the pilot site.

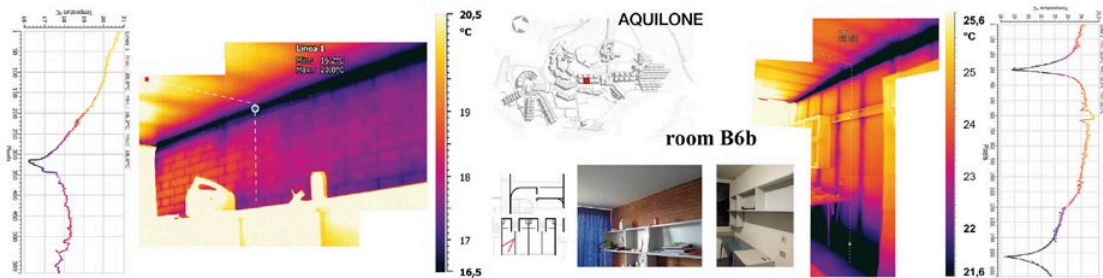

Figure 10. Room B6b before (30.11.2015) and after (9.2.2017) the pilot site. Heat losses are near the concrete structure.

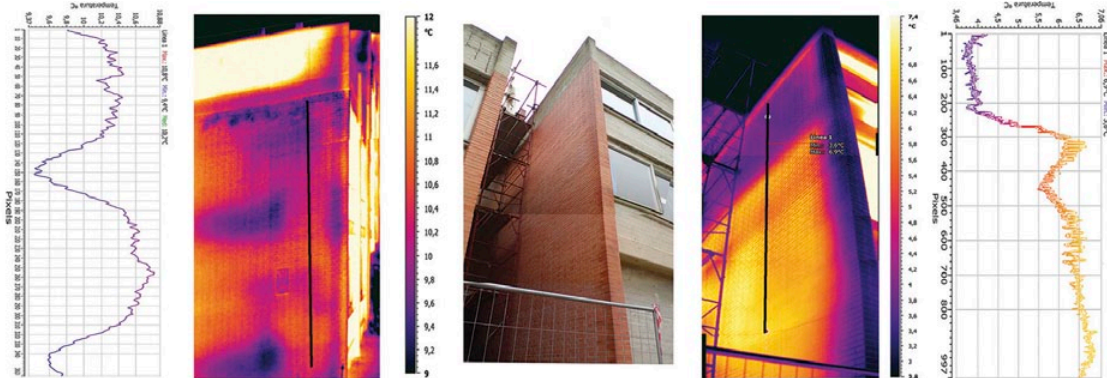

Figure 11. Pilot site: before 30.11.2015 and after 9.2.2017. Improved performance of the insulated wall.

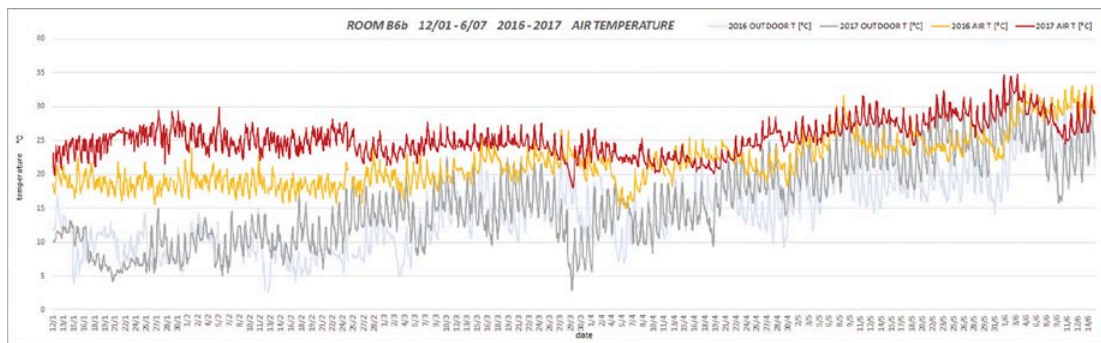

Figure 12. Room B6b temperature trend February – July. 2016 (yellow) vs. 2017 (red).

The on-field analyses have been repeated after the pilot site. Thanks to the application of the inner insulation on the external brick wall, the differences and the imbalances between the two rooms were considerably lowered. Thermal images confirm that surface temperature has increased after the application of the insulation layer, thus resulting in more comfortable conditions, especially for the students sleeping close to the wall. Unluckily, the exposed concrete structures resulted in thermal bridges, even after the energy retrofit (Figures 9, 10 and 11). The graph in Figure 12 draws a comparison between the data recorded before (yellow) and after (red) the pilot site. In room B6b, the external wall and roof slab have been insulated, and a new window has been installed. The winter temperatures measured after the pilot site are higher than the ones detected in winter 2016, and during the period February–April, average temperature resulted in an increase of +5.5 °C in comparison to the previous year (from 19.4 °C to 24.9 °C). Similar results have been achieved in room B6a, where insulation was applied only onto the roof slab and windows were substituted. Also in this case, insulation proved to be effective, as the average temperature in winter has risen by +4.4 °C, comparing to 2016. Nevertheless, such improved performances of the envelope might result into overheating both in winter and summertime. In fact, average temperature has increased from 22.4 °C to 26.8 °C and on sunny days 30 °C may be exceeded due to a greenhouse effect. The retrofitting of the building envelope should thus be integrated with a better and possibly local regulation of the heating system.

4. CONCLUSIONS

Improving the energy efficiency of a historic building is a critical issue as it is controversial to modify the original design and the material integrity of the building. The case of the Urbino University Colleges confirms the relevance of this topic even in 20th century architecture, where the need of adding insulation layers often leads to substantial alterations of the aesthetics of such buildings. To further improve the energy efficiency of such a large complex, alongside efforts towards the energy performance of the building envelope, the regulation of the heating system will also need to be improved. In general, the better a control system is linked to the measurement of local imbalances, the more manageable and effective it is. On the contrary, in such large centralized heating systems, it is not easy to define an effective correlation between the central set-points and the improvement of the local thermal conditions. This issue will have to be addressed in the near future.

Moreover, beside the actions towards the building insulation and the heating system regulation, it is worth involving the users in matching energy and conservation goals [4]. In fact, while optimal energy performances rely on detailed information and data about the indoor microclimate, they could also benefit from the users' attitude and their awareness towards these issues.

Interest towards smart home systems has recently increased, as they may be a way to improve indoor climate control by stimulating users to get involved in this task. T, RH and CO₂ thresholds may be used to control the heating system and to

activate ventilation and de-/humidification when needed. Moreover, an early alert could guide users in taking simple measures such as opening the windows when CO₂ concentration is too high. Even little adjustments to users' daily routine may have positive impacts on energy saving, and this would especially reflect on the domestic energy demand. An adequate or comfortable indoor environment relies onto the calibration of the heating system, even locally. The Urbino University Colleges are fully in use and have a homogenous population (hours, age, habits). This would allow to design specific actions on capacity building and soft skills, involving the users within a sustainable conservation strategy. Students' awareness of the good climate of the Colleges and their energy demand may be improved, together with the economic impact. This would lead towards a process of individual involvement and responsibility, where the behaviour of each student may result in lower energy consumption and money saving, which is a concrete approach to energy sustainability in architectural conservation and use.

5. REFERENCES

- [1] Zucchi B. Giancarlo De Carlo. Oxford: Butterworth – Heinemann; 1992.
- [2] D. Del Curto, L.P. Valisi, A. Luciani, D. Camuffo, C. Bertolin, A. Pallavicini. Patent for utility models: an electronic detection device of environmental quantities. Patent n. 202016000051842, 19.05.2016.
- [3] Fanger P. Thermal Comfort. New York: McGraw-Hill Book Company; 1972.
- [4] F. Berg, A.C. Flyen, Å. Lund Godbolt, T. Broström. "User-driven energy efficiency in historic buildings: A review", *Journal of Cultural Heritage*, vol. 28, pp. 188–195, 2017.

The impact of modernization of a 16th century timber-framed farmhouse, Suffolk, UK

C.J. Whitman¹, O. Prizeman¹, J. Gwilliam¹ and P. Walker²

¹ Welsh School of Architecture, Cardiff University, Cardiff, Wales, UK. Email: WhitmanCJ@Cardiff.ac.uk

² Department of Architecture and Civil Engineering, University of Bath, Bath, England, UK

Abstract – Well intentioned modifications to traditional buildings can potentially be detrimental if the full implications of the work are not fully understood. This paper presents the case of a 16th century Suffolk farmhouse. Extended in the 1700s, the timber-framed building was clad in cement render in the early 20th century. At a later date the timber sole plates were encased in concrete and painted with an impervious resin. Finally in 2005 the panel infills were replaced with rigid polyisocyanurate (PIR) thermal insulation. In-situ environmental monitoring and digital simulation are used to assess the impact of these measures on the performance of the building. The outcomes of this research are now being used to enhance the informed conservation of this building.

Keywords – timber-framed; energy retrofit; moisture monitoring; performance; unintended consequences

1. INTRODUCTION

Over the years those who care for historic buildings have sometimes taken decisions that, with hindsight, are now understood to have caused more harm than good. As we aim to make our historic buildings more energy efficient, we must take care that our actions enable the long term survival of these buildings and do not endanger their historic fabric [1]. Although in the UK, historic and traditional buildings are not required to fully comply with the energy efficiency requirements of the building regulations [2, 3], they must still aim to “improve energy efficiency as far as is reasonably practicable” and not diminish the buildings performance [2]. In addition, building owners and occupants wish to improve the thermal performance of their properties to reduce heating bills and improve thermal comfort. As such, both the extent and detail of any retrofit remains at the discretion of the building owner. Whilst it is hoped that they will seek advice from qualified professionals, the lack of knowledge in the construction industry with regard to energy retrofit in general [4], and especially related to historic and traditional buildings [5], combined with a reduction in historic environment specialist within local authorities [6], means that too often they do not. The building considered in this paper is one such case.

2. HOUSE, BATTISFORD, SUFFOLK, UK

2.1 INTRODUCTION

The case study, located in Battisford, Suffolk (Figure 1 & Figure 2) is a Grade II listed former farmhouse, whose origins date back to the 16th century [7]. The property is now a private residence with two occupants.



Figure 1. North entrance elevation of case study. Source: Author's own, 2017.



Figure 2. South, elevation. Source: Author's own, 2017.

2.2 HISTORY

The oldest section of the house, the lower wing (right in Figure 1), contains a small section of 16th Century plain crown post roof structure [7]. A second, taller wing is thought to have been constructed at right angles to the first in around the 17th Century, with an axial red brick chimney with sawtooth shaft (ibid). Subsequent additions were added in the 1980s with a porch to the north (Figure 1), an en-suite bathroom at the junction of the two wings (Figure 2) and a service block to the west.

2.3 CLIMATE

Along with the rest of the UK, Battsford is located in a temperate maritime climate with warm summers and cold winters. The climate is classified under the Köppen-Geiger climate classification system as Cfb (C-Warm temperate, f-fully humid, b-warm summers) [8]. The heating season typically lasts from November until March with no requirement for mechanical cooling during summer months. Figure 3 shows that compared to the UK average, Battsford experiences warmer temperatures throughout the year, and lower relative humidity in summer. The precipitation pattern also differs, with Battsford's maximum rainfall recorded in the summer, rather than the winter. This pattern is due to the reduced influence of westerly Atlantic fronts and an increase in summer thunderstorms, driven by convection [9].

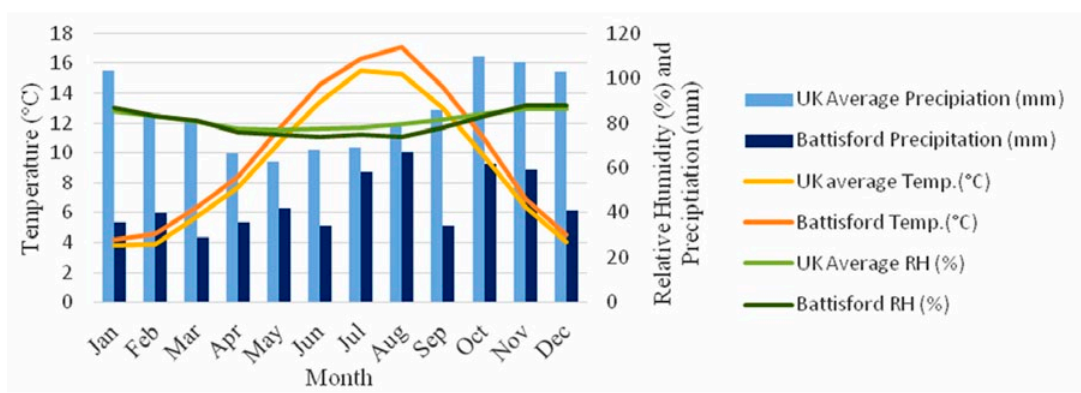

Figure 3. Climatic data for Battsford, Suffolk, UK. Source: (Meteonorm 6.0 and Met. Office UKCP09).

2.4 BUILT FABRIC

The timber-frame was overclad in cement render in the early to mid-20th century. The timber sole plates were then encased in concrete and their interior faces painted with an impervious resin. In around 2005 most of the lath and plaster infill panels were replaced with rigid polyisocyanurate (PIR) thermal insulation (Figure 4). In this detail, the cold-bridging of the historic timber-frame is exacerbated by the introduction of additional timber battening to take the plasterboard. The PIR insulation is not mechanically fixed or bonded and is left free-standing within the opening with large gaps around the sides in many instances.

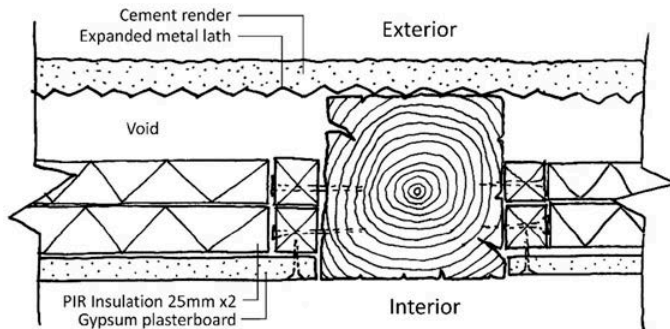

Figure 4. Sketch plan detail of replacement panel infill at case study. Source: Author's own, 2017.



Figure 5. Internal face of cement render. Source: Author's own, 2017.

On opening up the walls, it can be seen that the expanded metal lath used to carry the cement render has in many places completely corroded away and the original oak laths are also in a state of advanced decay (Figure 5). There are also areas where the external cement render is cracked allowing rain penetration into the wall and building interior.

It is likely that the cement render was applied to reduce the need for maintenance of the previous lime render and the PIR insulation installed to improve internal comfort conditions and reduce energy consumption. Both actions were presumably undertaken believing that they were improvements; however, neither have been undertaken with a full understanding of the performance of the historic built fabric, and have now resulted in the poor current condition of the building. Today many of the timbers are rotten and will require replacing and the cement render is in danger of collapse.

2.5 PROPOSED RENOVATION

The current owner proposes to remove all external cement render, PIR thermal insulation and gypsum plasterboard infill. The timber-frame will then be fully assessed and any necessary repairs will be undertaken. The house will be re-rendered in lime render on split oak lath, however some uncertainty over the preferred insulation material remains.

3. IN SITU MONITORING

3.1 INTRODUCTION

In order to assess the current performance of the building, the following in situ monitoring was undertaken; U-value measurement; pressure testing; thermography; timber surface moisture measurements; interstitial hygrothermal monitoring; hygrothermal monitoring of habitable spaces; and thermal comfort questionnaires.

3.2 IN SITU U-VALUE MONITORING

3.2.1 Methodology

A location on the North façade was selected to minimise the influence of direct solar radiation. The wall of the study was chosen due to the continual heating of this space. The monitoring equipment was installed midway between two vertical studs. The methodology employed was according to BS ISO 9869-1:2014 [10] using Hukseflux® HFP01 heat flux plates and thermistors connected to Eltek® wireless telemetry transmitters, relaying data to an Eltek® Squirrel® data logger, with data recorded at 5 minute intervals. The external thermistor was held in place with adhesive tape and internally with an extendable building prop and plastic clip. The in situ U-value monitoring was undertaken between 11/03/2017 and 03/04/2017, with a measurement period of 23 consecutive days.

3.2.2 Results and Analysis

The U-value measurements showed an average U-value of 1.72 W/m²K, with a standard deviation of 0.10 W/m²K. This is much worse than the calculated design U-value of 0.340W/m²K. Even when the timber frame is taken into account a U-value of 0.921 W/m²K is still calculated. This discrepancy is most probably a result of the poor detail design and installation of the insulation. Both the rigid PIR insulation and the gypsum plasterboard are ill suited to the irregularities of the timber frame. Opening up showed the PIR panels to be freestanding with a clear gap around the edges, allowing heat transfer around the panel by both convection and air movement. To compound this problem, there is no mechanical connection between the face of the insulation and the back of the cement render, thereby forming a ventilated cavity. This highlights the need for replacement infill panel details to acknowledge the complex three-dimensional geometry of historic timber-frames. Infill materials must be capable of adapting to these geometries without relying on careful craftsmanship and should form a seal between frame and insulation.

3.3 PRESSURE TESTING

3.3.1 Methodology

Pressure testing was undertaken on 11/03/ 2017, following BS EN ISO 9972:2015 [11] using a Minneapolis® Blower Door. It should be noted that during the testing some building work was being undertaken in the western section of the house, including new plasterboard partitions, which were not taped or skimmed. As

such, it is possible that the airtightness of the house is better than the test results suggest.

3.3.2 Results and Analysis

The pressure testing indicated an air permeability index of $19.0 \text{ m}^3/\text{h}/\text{m}^2$, an air change rate of $18 \text{ ac/hr}@50 \text{ Pa}$ or 0.9 ac/hr unpressurised, and an effective leakage area of 9.43 m^2 . Under current UK building regulations new-build dwellings must achieve an air-permeability index of no more than $10 \text{ m}^3/\text{hr}/\text{m}^2$ [12] with average air change rate for pre-1900 UK buildings of $12.3 \text{ ac/hr}@50 \text{ Pa}$ [13]. The poor performance of this case study may in part be due to the aforementioned ongoing building work, however the lack of airtight seals between infill panels and timber frame will be a major contributor.

3.4 THERMOGRAPHY

3.4.1 Methodology

Thermography was undertaken of the whole house using a FLIR® B250 on 11/03/2017 starting at 9:00 am. The building was unpressurised. An average temperature differential between inside and out of $7 \text{ }^\circ\text{C}$ was maintained throughout. This exceeds the minimum differential of $5 \text{ }^\circ\text{C}$ as recommended by Young [14].

3.4.2 Results and Analysis

Figure 6 shows the higher internal temperatures of the ground floor, especially the study (bottom-right) where a $10 \text{ }^\circ\text{C}$ temperature differential was achieved. The single glazed windows of the study and master bedroom are the weakest thermal element of this façade. The concrete encased brick plinth is shown to be a thermal bridge, as is the close studded timber frame which is clearly visible through the cement render.

The internal thermography (Figure 7) confirms the previously noted weakness of the junction between the modern PIR thermal insulation and the timber-frame. This detail has no sealant or taping and as such, thermal transfer through air movement is occurring. The low radiant surface temperature of the infill panel to



Figure 6. External thermography of east façade. Source: Author's own, 2017.

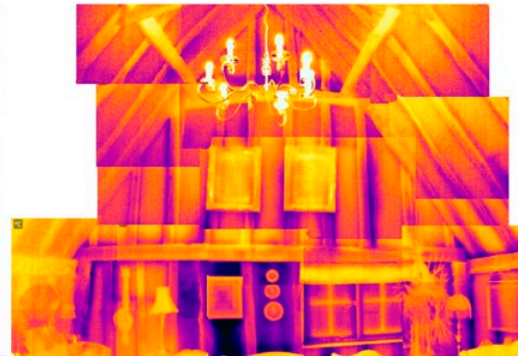

Figure 7. Interior thermography of north wall of drawing room. Source: Author's own, 2017.

the bottom centre left of the image is however unexplained and requires further exploration.

3.5 TIMBER SURFACE MOISTURE CONTENT

3.5.1 Methodology

Surface moisture content measurements were taken using a Testo® 606–2 resistance moisture meter for two ground floor walls, the east wall of master bedroom and the north wall of the study. The measurements were undertaken on 02/08/2016 and the 11/03/2017.

3.5.2 Results and Analysis

Figure 8 shows high moisture content in the sill beam of both walls due to their encasement in cement rendered brick externally and resin coated internally. Evidence of drying can be seen between the summer (upper) and winter (lower) measurements.

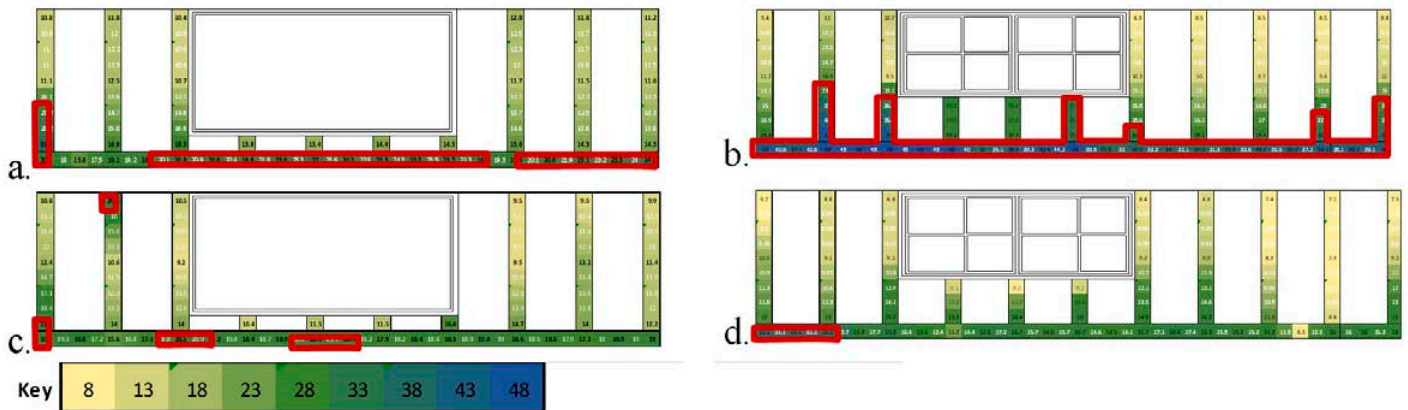

Figure 8. Surface moisture content (%) of timber-frame. Ground floor. Bedroom east wall (a. 02/08/2016 and c. 11/03/2017) Study north wall, (b. 02/08/2016 and d. 11/03/2017). Source: Author's own, 2017.

3.6 HYGROTHERMAL MONITORING

3.6.1 Methodology

Omnisense® GE Hygrotrac™ S-4 Wireless Dual Channel wireless sensors were used connected to electrical resistance sensors for measuring timber moisture content of the timber frame, and Hygrosticks™ measuring temperature (°C) and relative humidity (%) within the wall and habitable spaces. Each S4 sensor transmitted data at 30 minute intervals to an Omnisense® GE Hygrotrac™ Gateway connected to the internet. The monitoring was undertaken over a year from 02/08/2016 to 07/08/2017.

3.6.2 Results and Analysis

The results indicate that many of the monitoring locations are experiencing hygrothermal conditions favourable to biological attack (Figure 9). The most frequent risk is from deathwatch beetle, with the sill beam in the SE corner of the

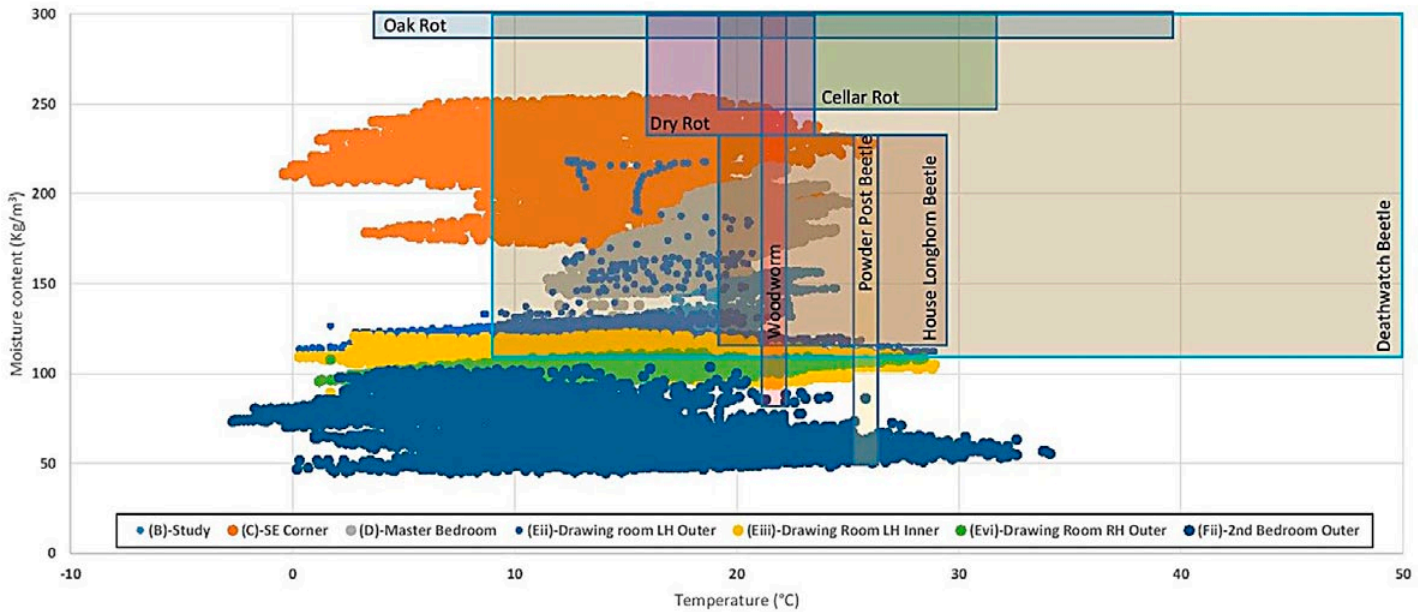

Figure 9. Hygrothermal conditions at monitoring positions with conditions favourable to biological attack overlaid. Source: Author's own 2017, with conditions favourable to biological attack based on [15].

master bedroom being open to this threat 99 % of the time. This location is also at threat from house longhorn beetle more than 1,000 hours per year. Within the same wall there also exists 249 hours when conditions are favourable for dry rot and 35 hours favourable to cellar rot. This further increases the risk of insect attack as both deathwatch and house longhorn will only inhabit wood previously damaged by decay. An instance of penetrating damp due to wind driven rain was recorded, with the affected area taking 9 months to return to its previous moisture levels.

The measurements within habitable spaces indicate that hygrothermal comfort was only achieved 38 % of the time in Master Bedroom, 26 % in the Study and just 4 % in the Guest Bedroom. In the Drawing Room hygrothermal comfort was achieved 50 % of the time, although it should be noted that no measurements were taken in this location over the winter months (02/11/2016–11/03/2017) due to the failure of a sensor. Despite these poor results, thermal perception questionnaires undertaken with the occupants concluded that both occupants found the ground floor of the house to be comfortable in winter but slightly warm in summer due to the underfloor heating and thermal mass of the ground floor. The converse was true with the upper floors, with both finding them comfortable in summer but slightly cool in winter in the case of one occupant and cold in the case of the other. The discrepancy between measured conditions and the occupants' perceptions may in part be due to the effect of radiant heating that was not measured but it may also indicate the occupants' willingness to accept lower comfort criteria in order to allow them to realise their ambition of living in a historic timber-frame building in a rural location.

4. ENERGY SIMULATIONS

4.1 METHODOLOGY

To assess the impact on energy demand of the changes that have already taken place, and to predict the potential for future retrofit measures, energy demand simulation was undertaken using the software DesignBuilder® Version 4.2.0.54. A weather file was created using the software Meteonorm version 6.1. The scenarios simulated are listed in Table 1 along with the change in energy efficiency, taking the current situation as a baseline (increase in efficiency (+) and decrease in efficiency (-)).

Table 1. Summary of scenarios simulated and results. Actual situation in red. All others are hypothetical

Scenario	Description	Air Pressure ac/h @50Pa	Air Pressure ac/h	Change in efficiency
1a	Assumed original lath and plaster with current airtightness	18	0.9	+1
1b	As 1a but with improved airtightness	10	0.5	+10
2a	Current situation as measured	18	0.9	0
2b	Calculated design u-value of wall but with airtightness as measured	18	0.9	+26
2c	As 2b but with improved airtightness	10	0.5	+35
3	Current situation (2a) but with all windows replaced with triple glazing	18	0.9	+2
4	Current situation (2a) but assuming improved airtightness	10	0.5	+9
5a	All infill replaced with sheep's wool lime plaster/render finishes.	18	0.9	+23
5b	As 5a but with improved airtightness	10	0.5	+32

4.2 RESULTS AND ANALYSIS

The simulations suggest that had the original lath and plaster not been replaced, the energy demand for the house could have been slightly better than the current situation. If the assumption that the original lath and plaster provided a more airtight junction with the timber-frame than the current unsealed plasterboard butt-jointed detail, then potentially the house may even have been 10 % more efficient. Obviously, the decrease in energy efficiency was not the intended outcome. If the thermal performance of the walls had achieved their calculated design value of 0.921 W/m²K, rather than the measured 1.8 W/m²K then a 26 % or 35 % reduction in heating energy demand would have been accomplished depending on the airtightness achieved. This highlights the need for the design of achievable details and good workmanship.

Of the future potential retrofit actions, replacing the cement render and PIR thermal insulation with an air tight vapour permeable solution such as sheep's wool and lime render on oak lath could improve the energy efficiency by up to 32 %. Given that this construction detail could adapt to the irregularities of the timber frame, it is more likely that a greater airtightness can be attained and that the design thermal performance can be achieved.

5. CONCLUSIONS

The monitoring has shown the damage that can be done through energy retrofitting without the correct guidance. The measured U-value is well below the calculated design value, most probably due to the poor detailing and excessive air movement around the insulation panels. This is confirmed by the thermography. Energy simulation shows that the house may well have been more efficient before the retrofit took place.

The timber moisture measurements and the interstitial hygrothermal measurements show that the historic timbers are saturated in many places due to the sealing of the building with impermeable finishes.

The hygrothermal comfort monitoring suggests that comfort conditions are achieved infrequently. This is however at odds with the occupants perceptions. This inconsistency may be due to comfort being provided by radiation which was not monitored or to lower comfort expectations. It is however clear that the radiant heating, from both the underfloor heating and the wood burner, do little to raise the air temperature.

Overall the decisions taken during the 20th Century and early 21st, although well intentioned, have led to a current situation where the historic structure is in danger of biological attack and collapse. It is hoped that the replacement of the cement render and PIR with finishes and insulation that are vapour permeable, coupled with repair, where necessary, of the timber frame, will save this building and provide it with a sustainable future.

- [1] Historic England, "Energy Efficiency and Historic Buildings: Application of Part L of the Building Regulations to historic and traditionally constructed buildings (Revised 2012)," in *Online*, English Heritage, ed. UK: English Heritage, 2012, pp. 1–63.
- [2] HM Government, "Approved Document L1B; Conservation of fuel and power in existing dwellings," ed: NBS, 2016.
- [3] Scottish Government, "Technical Handbook 2017 Domestic–Energy," ed. Online, 2017.
- [4] P. Bonfield, "Each Home Counts," Department for Business, Energy and Industrial Strategy & Department for Communities and Local Government 2016.
- [5] STBA, "Performance and Energy Efficiency of Traditional Buildings: Gap Analysis Study," STBA (Sustainable Traditional Buildings Alliance) 2012.
- [6] Historic England, Association of Local Government Archaeological Officers, and Institute of Historic Building Conservation, "The Ninth report on Local Authority Staff Resources," Historic England, Association of Local Government Archaeological Officers,. Institute of Historic Building Conservation, 2017.
- [7] Historic England, "The National Heritage List for England," Historic England, ed. 2014.
- [8] M. Kottek, J. Grieser, C. Beck, B. Rudolf and F. Rubel, "World Map of the Köppen-Geiger climate classification updated," *Meteorol. Z.*, vol. 15, pp. 259–263, 2006.

- [9] G. Manley, *Climate and the British scene*. London, 1955.
- [10] British Standards Institution, "BS ISO 9869-1:2014 Thermal insulation – Building elements – in situ measurement of thermal resistance and thermal transmittance Part 1: Heat flow meter method," ed, 2014.
- [11] British Standards Institution, "BS EN ISO 9972:2015 Thermal performance of buildings–determination of air permeability of buildings–fan pressurization method," ed: British Standards Institution, 2015.
- [12] *The Building Regulations. Approved Document Part L1 A conservation of Heat and Power. New Dwellings*, 2016.
- [13] D. Hubbard, "Ventilation, Infiltration and Air Permeability of Traditional UK Dwellings," *Journal of Architectural Conservation*, vol. 17, pp. 59–73, 2011/01/01 2011.
- [14] M. Young, "Thermal Imaging in the Historic Environment," *Historic Environment Scotland*, 2015.
- [15] I. McCaig and B. Ridout, *English Heritage practical building conservation-Timber*. London; Farnham, Surrey; Burlington, VT: English Heritage; Ashgate, 2012.

Integrated energy and hygrothermal analyses of heritage masonry structures in cold climates

M. Gutland, S. Bucking and M. Santana

Department of Civil and Environmental Engineering, Carleton University, Ottawa, Canada.

Abstract – The East Block building in Ottawa was built in 1859–1967 and has been suffering from chronic moisture-related deterioration for much of that time. With a major rehabilitation of the building being scheduled, it is an opportune time to assess the hygrothermal characteristics of the building in its current state. The Southwest Tower was fitted with thermocouples, heat flux sensors and RH sensors to collect real-time conditions over the fall/winter. Using this measured data, EnergyPlus and 2D hygrothermal software, an optimization process was used to calibrate important modelling parameters such as thermal conductivity, air infiltration, sorption and permeability. Designers can then extrapolate this knowledge to plausible future retrofit scenarios to be done which address sustainability or durability goals. Simulations can allow designers of the rehabilitation to better evaluate and understand the risk of further deterioration from moisture and increased freeze/thaw cycles; versus the reward of decreased energy consumption.

Keywords – energy modelling; hygrothermal modelling; masonry; monitoring; rehabilitation

1. INTRODUCTION

1.1 REHABILITATION OF CANADA'S PARLIAMENT BUILDINGS

The Parliamentary Buildings of Canada are historically significant for their role they have played in Canadian democracy; and as a unique and beautiful piece of Gothic Revival architecture. They have suffered the effects of time for 150 years and with neglected maintenance have begun to need urgent and major repair. Major rehabilitation projects have begun or are being planned for each of the three buildings; starting with current West Block Rehabilitation Project, Centre Block Rehabilitation Project (scheduled to begin 2018) and East Block Rehabilitation Project (Tentatively scheduled to begin in 2025).

Considering the Canadian Federal Government's Long Term Vision Plan (LTVP) [1] for the Parliamentary Precinct and Greening Government Strategy [2] policies to reduce greenhouse gas emissions and improve sustainability; there is a pressure to address the energy performance of the East Block building during its upcoming rehabilitation. Thermal retrofits of heritage buildings; particularly interior insulation of masonry is a controversial issue. In select sensitive cases, interior insulation has been attributed to a decrease in a wall's durability through freeze-thaw action and an inability to dry. It is imperative to understand both the thermal conditions inside the building and the hygrothermal properties of the envelope before proceeding with a retrofit of these buildings to avoid the risk of compromising the wall's durability.

1.2 SOUTHWEST TOWER

The Southwest Tower rises approximately 47 m tall and is the architectural focus of the East Block building. The tower consists of mass masonry walls consisting of inner and outer stone wythes (~225 mm) sandwiching a grouted rubble core. The thickness of the walls varies—tapering from 2100 mm at the plinth to 860mm toward the top. The load-bearing walls have been known to experience chronic moisture-related decay for many years. This resulted in problems such as surface staining, displacement, erosion of stones and mortar, and deconsolidation of mortar within the masonry core. The decay mechanisms at play are numerous, including uncontrolled water exposure, freeze-thaw and incompatible selection of repair mortars with the stone.

The two-storey lobby of the tower serves as the ground floor, and is capped by a groin vault ceiling. An intricate stained-glass window provides light to the space. The fourth level (immediately above the lobby) serves as the base of the upper part of the tower. The tower zones are characterized by large floor-to-ceiling heights (~12.0 m, 7.9 m and 7.9 m for the lobby, fifth and sixth floor respectively).

The upper parts of the tower do not have a dedicated HVAC system. The fourth level used to house electrical/electronic equipment which generated a significant amount of heat. This equipment has recently been removed. The fifth, sixth and seventh floor have no HVAC equipment. Because of the semi-conditioned nature of the upper stories of the tower, the interior conditions fluctuate greatly over the seasons and cannot be accurately represented in hygrothermal simulations by fixed values or sine curves over the course of the year. To improve the accuracy of the hygrothermal simulations, we must integrate building energy modelling.

1.3 METHODOLOGY

This project has four main stages, some of which are in progress and not presented:

- 1) Sensor Installation and Data Collection;
- 2) Calibrated Energy Modelling;
- 3) Calibrated Hygrothermal Modelling (in progress);
- 4) Future Retrofit Scenarios (in progress).

2. DATA MEASUREMENT

A network of sensors connected to Campbell Scientific data loggers, was installed in strategic locations in the tower to monitor the changes in conditions over time; and to use for model calibration. Thermocouples were placed to measure zone air temperatures and interior surface temperatures. Heat flux sensors were positioned on the interior surface. Relative humidity and embedded moisture content sensors were inserted into the wall to monitor hygrothermal conditions. Time and practical restrictions precluded sensor installation on the exterior. Ambient conditions were measured by the data logger's internal sensors.

Figure 1 shows the measured and ambient temperatures from the period of August to December. It is seen that as we go higher within the tower, that the

ambient temperatures begin to approach the outdoor temperatures. The temperatures on the fifth and sixth levels dip below freezing in December. Figure 2 compares the 2017 data to the temperature data measured from 2012–13 in when the heat generating electronic equipment in Zone-4 was still active [3]. Never was there an average daily temperature below freezing, and the temperatures in Zone-4 and Zone-5 were within a reasonably comfortable range throughout the

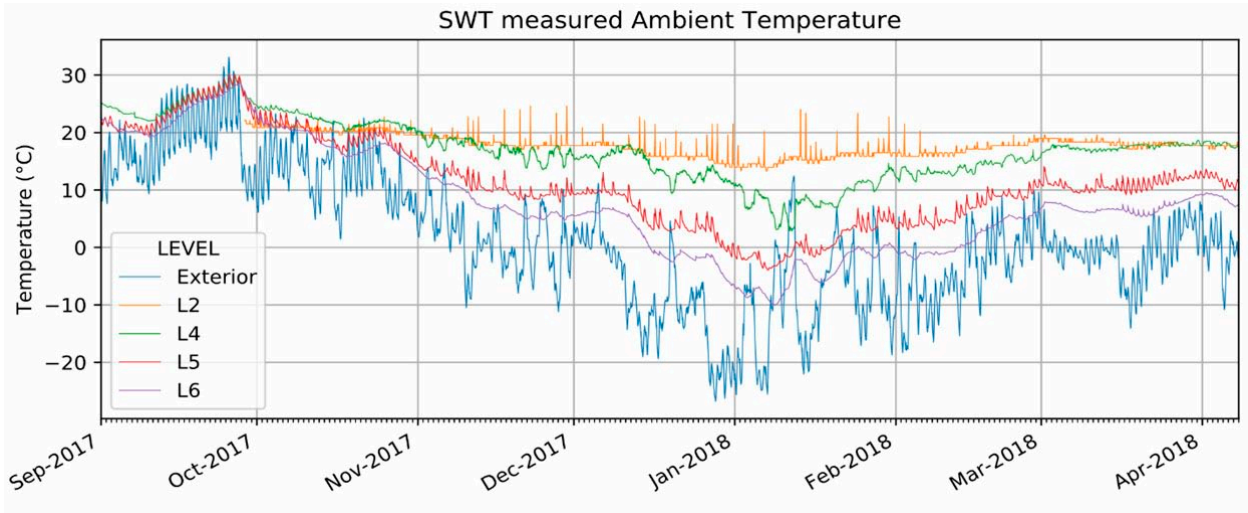

Figure 1. Measured and ambient temperatures for the Southwest Tower.

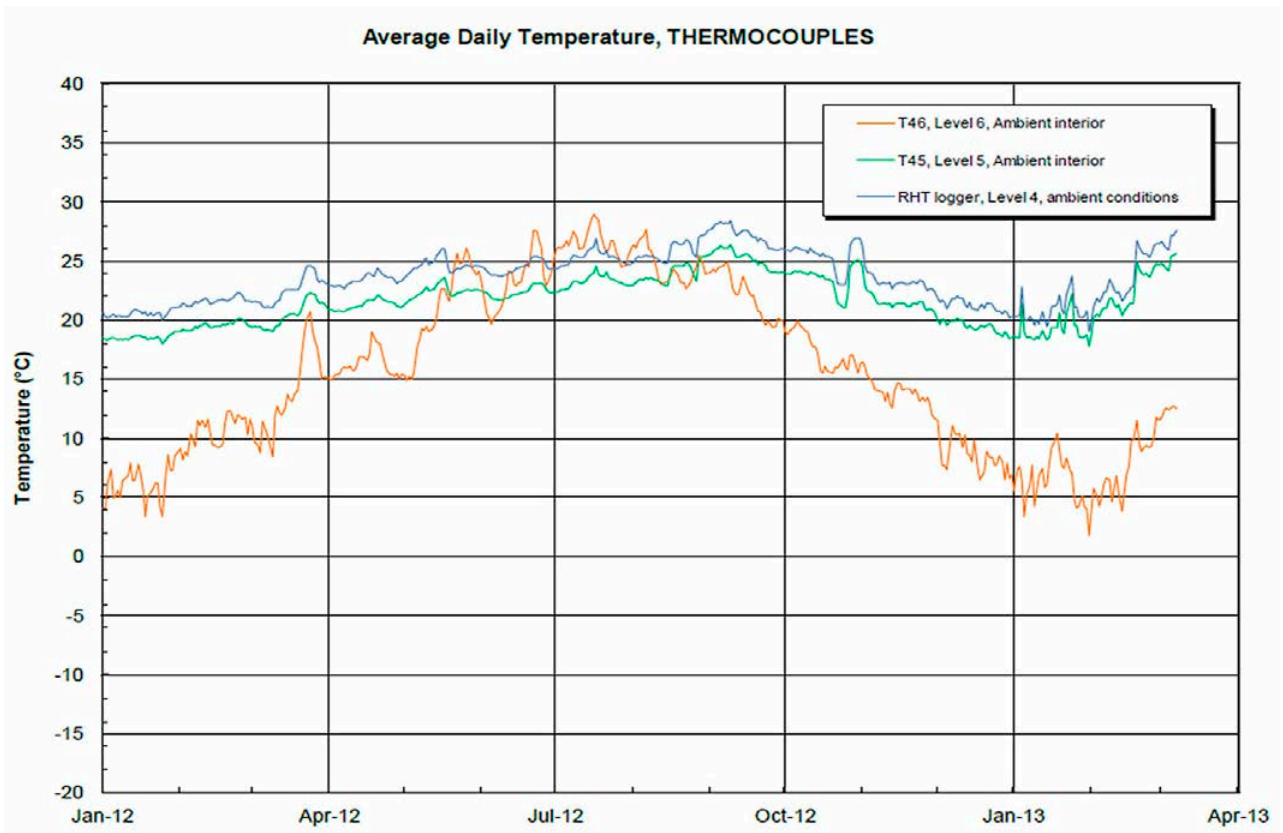

Figure 2. Measured and ambient temperatures for the Southwest Tower from 2012–2013.

year. Obviously, the removal of the electronic equipment from the tower has had a significant negative influence on the conditions within the tower. The effect this will have on durability will be explored in later stages of this project.

3. SIMULATION PROCEDURE

3.1 ENERGYPLUS MODEL

An EnergyPlus model of the Southwest Tower and adjacent pavilions was created based on drawings and point clouds provided by Public Works–Heritage Conservation Services. Because of the changes in thickness and decorative carved elements it is difficult to define a clear-field assembly. The exterior walls were sub-divided into sections to represent this as best as possible, with an eye towards model simplicity and future hygrothermal analysis. All masonry walls were divided into an outer wythe (225 mm), rubble core (variable thickness) and inner wythe layers (225 mm). The thermal properties of the core were assumed to be the same throughout the building, ignoring the effects of voids and the inconsistent nature of its construction, from one wall to the next. The Conduction Finite Difference algorithm was chosen for all exterior surfaces. A cross-section of a typical wall section is shown in Figure 3 [4]. The Southwest Tower's windows are all single pane, stained glass, leaded glass or plexiglass and held in place by stone on the exterior and iron stops on the interior and modelled as such.

For model simplicity, an ideal loads system was entered instead of explicitly modelling an HVAC system. Tower Zone-1 receives ventilation air from an air handling unit running from the basement. There is also air circulation from large open corridor doors on the adjacent wings of the building. Airflow between the corridors and the tower was modelled as a flow rate at room temperature.

Tower Zone-4 and up has no dedicated HVAC system. A constant volume fan exhausts air to Tower Zone-5 and is always operating. The volumetric flow rate expelled by the fan was modelled as a constant Zone Mixing object in EnergyPlus. Replacement air for the fourth level comes from infiltration from the neighbouring conditioned zones of the South and West Pavilions, as well as re-circulation downward from Tower Zone-5 via a large opening in the floor. This replacement air was assumed to be coming from adjacent zones of the building at near room temperature and modelled using a maximum flow rate in the Zone Ideal Loads object.

Tower Zone-1 (a two-storey circulation lobby), Zone-5 and Zone-6 have especially tall floor-to ceiling heights (~12.0 m, 7.9 m and 7.9 m respectively) where temperature stratification means the assumption of well-mixed air is likely invalid, especially during winter. The effects of stratification and stack were modelled via Zone Mixing objects from one level to the level above. Lighting and occupancy related loads are minimal. The building is sparsely occupied compared to a typical office building. The upper stories of the Tower are only occupied for rare maintenance and downloading data from the data loggers.

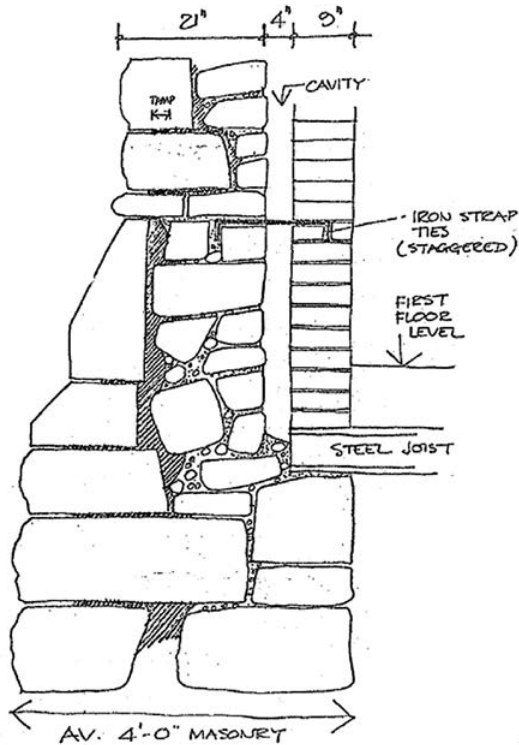

Figure 3. Typical cross-section of the East Block walls. Note that the tower does not have a cavity and brick inner wythe.

Weather data was obtained from the Urbandale Centre for Home Energy Research [5] project on the Carleton University Campus and supplemented with data from Environment and Climate Change Canada [6]. The Urbandale Centre has recorded Global Horizontal and Diffuse Horizontal solar data as well as ambient temperature and relative humidity.

4. SENSITIVITY ANALYSIS AND CALIBRATION

4.1 SENSITIVITY ANALYSIS MODEL

The calibration process was based on a procedure developed by Roberti et al [7] adapted for use in this project. The first step (1) was to develop a baseline model with assumed material properties and modelling parameters retrieved from ASHRAE, WUFI etc. or professional judgment; (2) perform a sensitivity analysis to determine which parameters had the greatest influence on results; (3) calibration of the model against measured zone air temperatures over the specified time range by adjusting values for key parameters identified in the previous step.

The sensitivity analysis was performed over time range of 1 September–17 December 2017. GenOpt optimization software was used to calibrate the EnergyPlus model against measured interior ambient temperatures [8]. The Particle Swarm Algorithm in GenOpt was used to minimize the Root Mean Square Error (RMSE) of the model's results compared to measured data. The cost function in GenOpt was the RMSE for all four zones with measured temperatures. The RMSE was also reported for each level and for a hot week, cold week and a week with average temperatures. The theory is that different parameter values will predict what is happening in the tower better in summer than in winter, specifically parameters relating to infiltration, stack and air movement within the tower.

The sensitivity analysis was performed by changing only one variable at a time over a predetermined range. Parameters which did not significantly affect the results were not to be included in the final calibration model. Parameters which were analysed include EnergyPlus objects related to HVAC, zone mixing, infiltration, conductivity, heat capacity and optical properties of windows. Minimum and maximum values were judged from plausible values in documentation and from pre-calibration trials.

Zone infiltration was modelled using a constant ACH with temperature and velocity coefficients based off the BLAST default model [9]. Pre-calibration trials showed that zone mixing had a significant effect on the accuracy of the model's zone air temperatures when compared to the measured temperatures. The pre-calibration trials also showed that very high flow rates up to 5 m³/s were plausible solutions to the optimization solution, so they were included in the sensitivity analysis.

A wide range of values for the conductivity of masonry materials was inserted into the sensitivity analysis. This reflects the typical uncertainty involved with the hygrothermal properties of masonry materials. As an example, the ASHRAE Handbook gives the thermal conductivity of sandstone from 1.88 to 6.2 W/m-K [10], while a study by Pechinig et al gives values ranging from 1.5 to 4.0 W/m-K [11]. The ranges for optical properties were estimated from WINDOW assuming a 3 mm single-pane clear glass.

4.2 SENSITIVITY ANALYSIS RESULTS

The sensitivity analysis results can be seen in Figure 4. Black bars indicate the RMSE for all four measured zone temperatures and grey bars represent the maximum RMSE for a zone. The largest RMSE's were for parameters related to air transfer into a zone, and zone mixing.

Infiltration rate, and the coefficients used to predict it, have a moderate effect on results and will be included in the final calibration. Building envelope parameters had a surprisingly low influence on the temperatures of the building. The conductivity of sandstone and the core have a measurable influence on results and will be included in the final calibration model. Heat capacity had little effect on the model and will not be included in final calibration. The lime concrete of the floors had little influence and will not be included in the final calibration either. Optical properties did not have a significant impact on results. Other than on the fifth level, the window-to-wall ratio is quite low on the building (max 0.12). Parameters relating to the basement or the seventh storey have little effect, largely because there are no measured data in those zones to compare to.

4.3 FINAL CALIBRATION MODEL

The 14 most significant parameters found in the sensitivity analysis were included in the final calibration model. Discrete values were used in GenOpt's Particle Swarm algorithm. The most sensitive parameters were defined with finer intervals between consecutive values, while the least sensitive were defined with coarser intervals. A summary of the parameters is shown in Table 1. The timeframe of the final calibration model was from 1 September to 30 January. The extended timeframe compared to the sensitivity analysis gives greater weight to winter conditions where conditions are more critical. The inflowing replacement air temperature to Tower-4 was modified to fluctuate over the course of the year, assuming it enters at varying temperatures whether it's the middle of summer, autumn or winter.

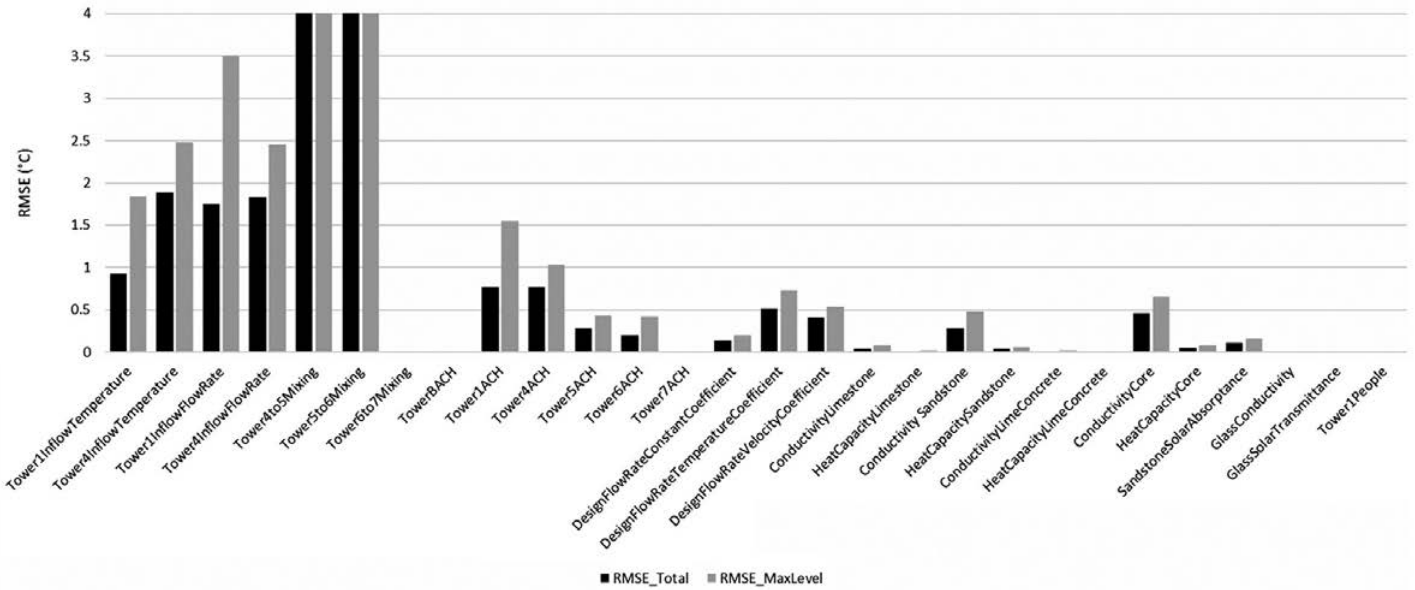

Figure 4. Sensitivity Analysis results.

Table 1. Calibration Values

Run	Parameter	Min Range	Max Range	Initial	Interval	Calibration results
1	Tower1InflowAirTemperature	18	24	21	0.25	20.75
2	Tower4HotInflowAirTemperature	24	29	26	1.0	28.0
-	Tower4WarmInflowAirTemperature	20	25	22	1.0	25.0
-	Tower4MediumInflowAirTemperature	18	24	20	1.0	24.0
-	Tower4ColdInflowAirTemperature	15	20	17	1.0	20.0
3	Tower1InflowAirFlowRate	0	1.5	0.75	0.125	0.5
4	Tower4InflowAirFlowRate	0	1.5	0.75	0.125	0.1
5	Tower4to5Mixing	0	5	2.5	0.25	0.25
6	Tower5to6Mixing	0	5	2.5	0.25	0.25
9	Tower1ACH	0.1	0.9	0.5	0.1	0.4
10	Tower4ACH	0.1	0.9	0.5	0.1	0.1
11	Tower5ACH	0.1	0.9	0.5	0.1	0.15
12	Tower6ACH	0.1	0.9	0.5	0.1	0.15
15	DesignFlowRateTemperatureCoefficient	0	0.075	0.036596	0.01875	0
16	DesignFlowRateVelocityCoefficient	0	0.25	0.1177	0.0625	0
19	Conductivity Sandstone	1	4	2.5	0.25	1.5
23	ConductivityCore	1	4	2.5	0.25	2.75

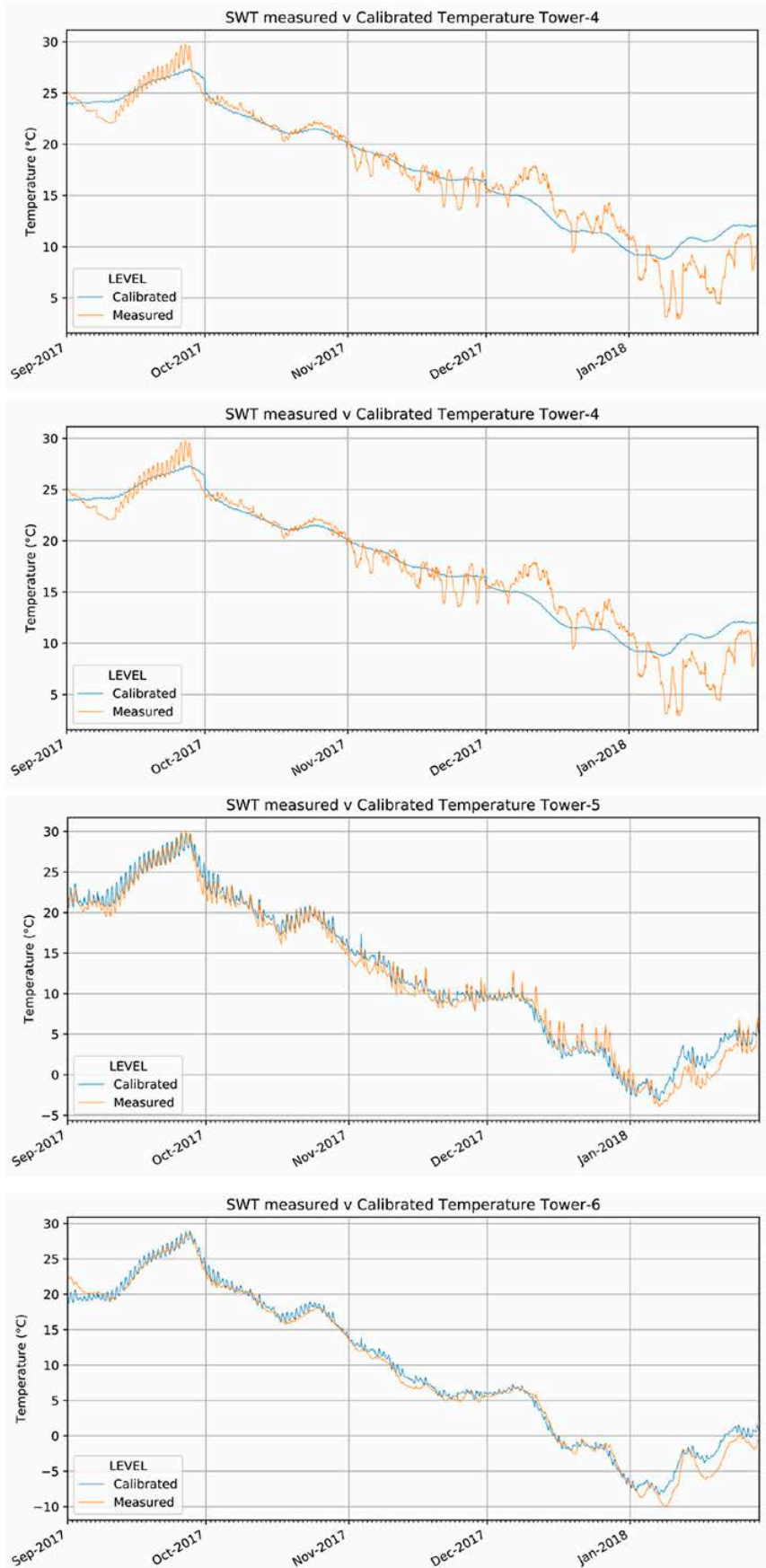

Figure 5. Measured v. calibrated model temperatures for Levels 1, 4, 5 and 6.

Final values from the calibration are summarized in Table 1. Figure 5 shows the measured v. calibrated curves for each of the four storeys. Tower-4 has the weakest correlation (RMSE=1.753) between measured and modelled data, particularly in the cold winter months of December and January. The model also lacks the diurnal temperature fluctuations of the measured data. Possible reasons for this could be excessive thermal mass, underestimated air infiltration and the fact that inflowing air into Tower-4 fluctuates diurnally, whereas the model is at a fixed temperature. Tower-5 (RMSE=1.078) and Tower-6 (RMSE=0.957) have a much stronger correlation than Tower-4. The Tower-6 calibrated model shows noticeable diurnal fluctuations whereas the measured data do not. Further dissecting the calibration results, the RMSE during a cold week was much higher than the rest of the calibration period. The parameter which seems to improve the RMSE during cold periods the most, is the volume of inflowing air into Tower-4. Further refinements to improve calibration, are to vary certain parameters based on time of year; or outside conditions.

5. FUTURE STAGES

The end goal of the project is to analyse the hygrothermal performance and durability of the walls using WUFI 2D. Information gathered from the EnergyPlus calibrated model to be used in the hygrothermal modelling stage includes the thermal conductivities of the stone and core, as well as the interior environmental conditions. Using a similar calibration process to what was done with the EnergyPlus model, the measured RH and %MC data will be used to calibrate important and uncertain hygrothermal parameters.

The goal of this process is to both characterize the building's performance in its current state and to help define hygrothermal properties of the mass masonry walls in-situ. The rubble core of the masonry is a notable area of hygrothermal uncertainty, considering there is known to be significant voiding and disaggregated mortar. Because of the irregular and random nature of the core, it may behave like mortar, stone or sand hygrothermically. When drilling through from the interior to insert sensors, it was found that there were large voids hidden behind and the mortar had a soft, damp and sandy consistency. The presence of air pockets and the disaggregated mortar will alter the hygrothermal performance compared to a sound and solid core. It may also exhibit some rainscreen like behaviour with the voids acting as a capillary break.

As part of the planned rehabilitation, retrofits specific to the Southwest Tower and thermal retrofits for the whole building are likely to be considered. By applying changes to the calibrated energy and hygrothermal models, we can better judge the effects this will have to the performance of the walls. This will allow designers to make more informed decisions regarding the risk of increased deterioration of the walls versus the reward of decreased energy consumption and better thermal comfort. Examples of retrofits which can be simulated include reinstatement of the electronic equipment on the fourth floor, fully conditioning the tower and insulating the walls from the interior.

6. REFERENCES

- [1] Public Serviced and Procurement Canada, “The Long Term Vision and Plan – The Long Term Vision and Plan Annual Report 2015 to 2016,” Ottawa, P1–26E-PDF, 2016.
- [2] “Greening Government Strategy.” Treasury Board of Canada Secretariat, 11-Jan-2018.
- [3] R. Glazer, “Hygrothermal Monitoring of Southwest Tower, East Block, Parliament Hill,” National Research Council, A1-002613-02.1, Mar. 2013.
- [4] J. Ashurst, “Departmental Buildings, Eastern Block, Parliament Hill. Ottawa,” 1977.
- [5] “Urbandale Centre for Home Energy Research.” Carleton University, 2017.
- [6] “Historical Data.” Environment and Climate Change Canada, 2017.
- [7] F. Roberti, U.F. Oberegger and A. Gasparella, “Calibrating historic building energy models to hourly indoor air and surface temperatures: Methodology and case study,” *Energy Build.*, vol. 108, pp. 236–243, Dec. 2015.
- [8] Lawrence Berkeley National Laboratory, *GenOpt – Generic Optimization Program*. 2016.
- [9] “EnergyPlus Version 8-8-0 Documentation–Engineering Reference.” U.S. Department of Energy, 26-Sep-2017.
- [10] American Society of Heating, Refrigerating and Air-Conditioning Engineers, “Chapter 26: Heat, Air and Moisture Control in Building Assemblies – Material Properties,” in *2013 ASHRAE Handbook – Fundamentals*, American Society of Heating, Refrigerating and Air-Conditioning Engineers, 2013.
- [11] R. Pechnig, D. Mottaghy, A. Koch, R. Jorand and C. Clauser, “Prediction of Thermal Properties for Mesozoic Rocks of Southern Germany,” presented at the European Geothermal Congress 2007, Unterhaching, Germany, 2007.

How sustainable was Connecticut's historic Saltbox house?

T. Sawruk, T. Adekunle and J. Hegenauer

Department of Architecture, University of Hartford, West Hartford, Connecticut, USA.

Email: sawruk@hartford.edu; adekunle@hartfod.edu; hegenauer@hartfod.edu

Abstract – This paper addresses passive sustainability as the dominant characteristic in the creation of a critically regional residential design. Intricately tied to regional locations by materials and design, the American Colonial Saltbox house (1700) realized an innovative response to extreme climate conditions. While the research considers the innovation and efficiency of this sustainable precedent, in theory, there are few empirical studies to verify the attainment of passive design success. Utilizing computer modeling and energy simulations, this paper explores the performance and efficiency of this historic prototype. Was the Saltbox actually as sustainable as the theoretical model suggests? The paper will report the findings of these computer simulations, testing the sustainable validity of this historic prototype.

Keywords – colonial architecture; historic precedent; saltbox, sustainable design; passive solar

1. INTRODUCTION

Historic buildings are important precedents often considered by designers, contractors, and home-owners when constructing contemporary residential projects. Based on the cultural heritage and use of traditional building methods, these models are often valued academically by historians and architects. Antique buildings provide a link between current residents and their past culture. In many cases, they provide social, emotional, and lifestyle continuity for local people, whether in the form of historical artefacts or, as you can see in the slide, pastiche simulations. Often, historic buildings are preserved via drawings, photographs or written commentary. However, only a few empirical studies have investigated the physical performance of the physical attributes of these structures and their value as sustainable prototypes.

A previous study evaluated the attic and its effect on the energy performance of historic buildings [Fabbri & Brunetti, 2015]. This study found that the space-controlled (especially attic-controlled) heat transfer between indoor and outdoor spaces; thereby, contributed to the heat loss saving in the building. The strategy of space ventilation, and the benefits of the ventilated attic for controlling high levels of energy consumption in historic buildings has also been discussed in a review study conducted by Al-Obaidi et al. (2014). The influence of the ventilated spaces on the building performance of the buildings has also been investigated [Dimoudi et al., 2006]. Nevertheless, none of the existing studies evaluated the overall building performance, or how sustainable the historic Saltbox house model

was throughout the year. As a result, this paper investigates the sustainability of Colonial buildings, using a Connecticut Saltbox house as the case study.

2. BACKGROUND TO THE STUDY- COLONIAL SETTLERS

When English settlers first landed on the shores of the new world in 1620, they confronted on-going challenges along the frontier. These environmental challenges directly contributed to the manner in which the settlers built their houses during the latter part of the century [Bock, 2001]. While their intended destination was the Virginia colony, a location with a relatively temperate climate, storms blew the Mayflower off course during the ocean crossing [Philbrick, 2006]. When the Colonialists arrived in late December, the New England climate was cold. A lack of provisions and freezing temperatures resulted in the death of almost half the initial Mayflower party.

As the colonists established settlements, the shelters they constructed mimicked the heavy-timber and “wattle-work” of English cottages familiar to them from their homeland [Colkert, 1985; Nevill, 1889]. A simple cottage plan consisting of two rooms, a “hall” and a “parlour,” separated by a fireplace was introduced [Garvan, 1951; Newcomb & Foster, 1932]. The first floor was mirrored with two sleeping rooms above. The Gleason House (c. 1650) in Farmington, CT, provides a fine example of traditional English houses as shown in Figure 1 [Alsop, 1986]. While this precedent served its purpose in providing shelter, it did not adequately address the extreme variation in seasonal temperature and the related snow and rainfall [Baker, 1994]. During the next half-century, residential architecture in New England was radically modified, actively responding to the settlers’ new, harsher environment.

The New England Saltbox house was introduced around 1670, and eventually became the prototype for residential construction throughout the northern colonies [Bock, 2001; Builder, 2001]. The Lt. John Hollister House in South Glastonbury, CT, 1675 provides a fine example of a Colonial Saltbox (Figures 2, 3, 4). Initially introduced as various service spaces sheltered under lean-to roofs, the style was solidified when a permanent service bay was added to the back of the house [Walker, 1996]. The extended back roof gave the new structure a form



Figure 1. Gleason House, (1650), Farmington, CT.



Figure 2. Hollister House, (1675) Glastonbury, CT.

similar to an English “Saltbox,” and thus the name was coined [Shelton, 1901]. While the new kitchen, pantry, and garret provided much needed spatial enhancements, the form also responded to the harsh northern winds, warning southern sun, and cool cross breezes.

In organization, form, and detail, the Saltbox house utilized multiple aspects of passive solar design. The design of the Saltbox house incorporates an east-west orientation, a cluster room plan, mud-filled thermal collector walls, direct solar gain rooms, a convection heat loop, various shade layers, and a central masonry thermal mass [Pollard, 2000]. In combination, these design strategies create a system to collect, store, and distribute heat, with numerous aligned openings to provide natural ventilation throughout the year [Builder, 2001]. The clustering of rooms around the thermal mass of the chimney allows for isolation and expansion of living space with barrowed heat throughout the day and night [DeKay & Brown, 2014].

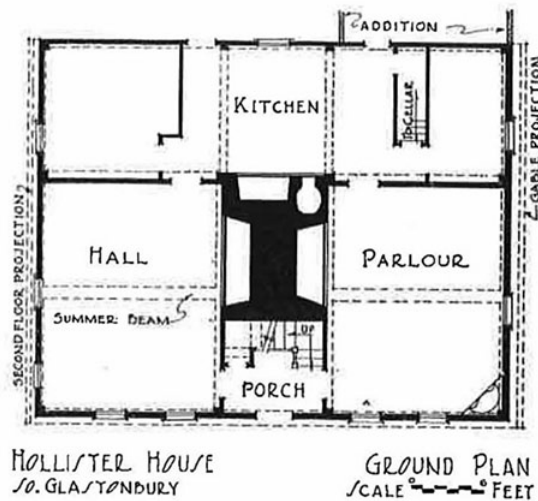

Figure 3. Hollister House. Plan.

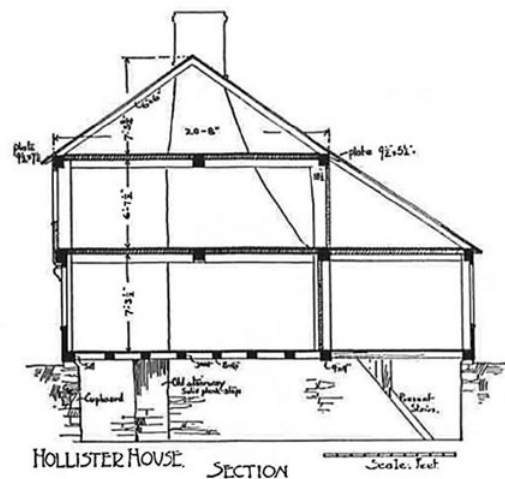

Figure 4. Section, Hollister House, (1675) Glastonbury, CT.

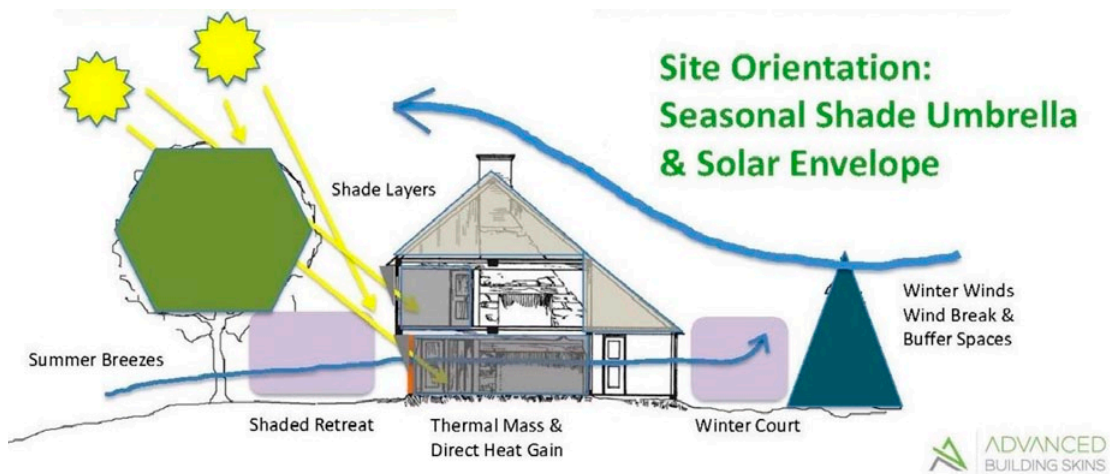

Figure 5. Site Orientation, Seasonal Shade Umbrella & Solar Envelope [Sawruk, 2017].

When located on an inclined hill, with tall deciduous trees to the east, south, and west, and evergreens to the north; the Saltbox house theoretically becomes an ideal microclimatic construct for a seasonal living (Figure 5). “The front yard thereby serves as a shaded retreat in summer and fall, while the form of the Saltbox shields it from the winter winds, creating a loosely defined “winter court” or sunny, protected outdoor room through till spring” [Sawruk, 2017]. If one considers this vernacular residence through a lens of sustainability, one can consider the extent to which this structure addresses its environment. Did Colonial Americans realize a prototype that bares reconsideration in our currently emerging climatic energy crisis? Is the Saltbox house a truly sustainable prototype?

3. CONSTRUCTING THE MODEL

To explore the merits and relevance of the New England Saltbox, the study constructed a digital model of the ideal Colonial Saltbox and assessed its qualities using energy modeling software. This study utilized a 2018 ‘standard’ Revit computer-aided design (CAD) program to generate a three-dimensional model in digital space. The Saltbox model followed an existing, and previously delineated historical precedent, the Hollister House (1675) of Glastonbury Connecticut, which was modified to reflect an ideal site and plan arrangement, with traditional Colonial construction methods (Figure 6). The modeling process began by reviewing the historic measured drawings, and programming the wall typology by establishing the wall structure and building materials. Exterior walls were developed to establish the building perimeter, with the interior walls and fireplace massing added after. The CAD “mass-in-place” feature allowed the

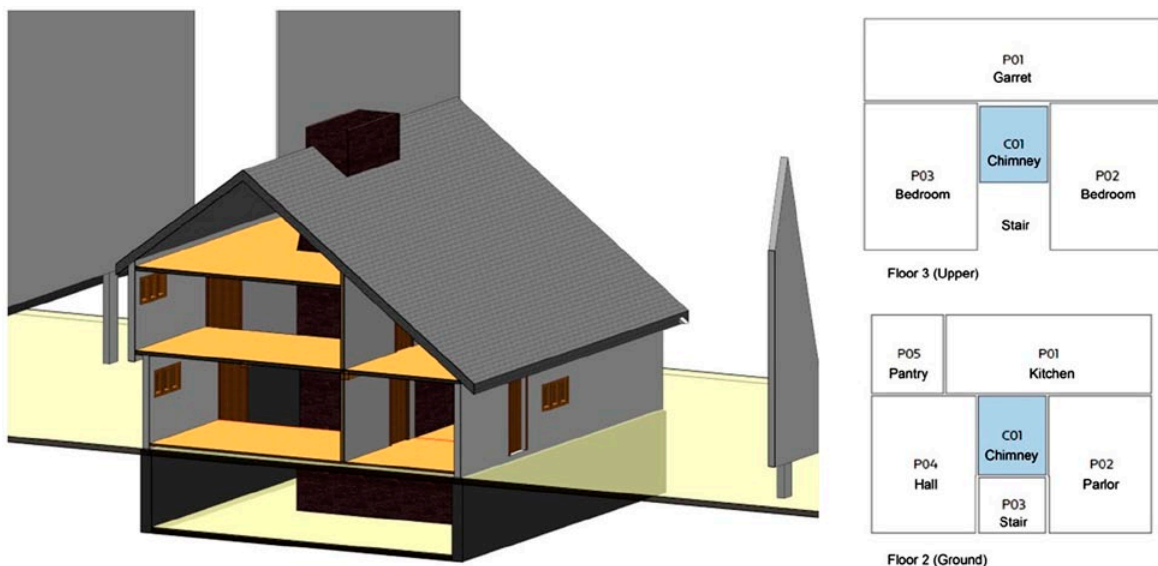

Figure 6. CAD: Revit Model of Ideal Saltbox House Figure 7. Second and Third Floor Room Delineation.

unique form of the fireplace to be established, which was then extruded to realize its final configuration. The “wall-by-face” feature allowed the chimney plane to be assigned specific masonry wall characteristics. For the modeling, the building is considered to be naturally ventilated in the summer months, with the fireplace is regarded as the source of heating of the living spaces during the winter months.

The second floor was created similarly, with the roof being generated from the walls of the second floor. Colonial doors and windows were added in relation to the historic precedent, while modifications were introduced to conform to the historic period and theoretical ideal. For example, the current Dutch, double-hung windows installed in the early 1800s, were substituted with small-scale, beveled-glass, casement windows, typical of the eighteenth century English building customs. After completing the overall form, each room within the model was assigned an individual delineation per floor (P01–P04), and the building was placed on a digital site (Figure 7). The site location reflected the ideal topographic slope, sun orientation, and landscape features to support a passive solar design.

4. PROTOTYPE ANALYSIS

Sefaira architecture and Sefaira systems energy modeling programs were used in conjunction to analyze the ideal CAD model [Sefaira, 2017]. Once the CAD model was completed, the prototype was uploaded to the Sefaira analytical program.

A general geographic location of Glastonbury, Connecticut was specified to provide climatic constraints. Data input for the CAD model included wall, floor, and roof R-values; glazing U-values; solar heat gain coefficients; solar shading design features (i.e., building overhands and landscape features); and a human coefficient of five individuals (Table 1). While the cooling parameters could be set to consider natural ventilation, a limitation of the Sefaira program consisted of the program defaulting to a “heating and ventilation only system 9” identification to represent the chimney mass.

Based on representative Colonial seasonal room utilization, two zoning compositions were defined for the research analysis. During the summer months, the entire interior was considered. During the winter months, a smaller footprint of three adjacent internal spaces consisting of the kitchen, parlor, and chimney mass were considered. To begin the analysis, set points of heating and cooling during the calendar year were determined, and the Sefaira program output hourly data for the entire year of dry bulb temperature.

Table 1. Sefaira U-Values of Building Envelope

Building Envelope	Assembly	U-value
Wall: Timber Framed Mud Filled	Masonry	4.98
Window: 0.5m x 0.6m Each	Single Pane Glass	4.03
Roof: Wood Deck, Shingle Roof	Wood Deck	4.98
Floor: Hard Wood Deck	Hard Wood	4.98

5. FINDINGS

External temperature data for the study was derived from the aggregate of the geographical location, recorded over multiple decades. The average external temperature was reported monthly from January (#1) through December (#12) (Figure 8). From this data, it was determined that January (#1) was the coldest, with an average monthly temperature of -4°C (24.8°F), and July (#7) was the hottest, with an average monthly temperature of 25°C (77°F). Based on Colonial (1700) concepts of dress and habitation, a winter comfort level of $15\text{--}20^{\circ}\text{C}$ ($59\text{--}68^{\circ}\text{F}$) was utilized in this analysis.

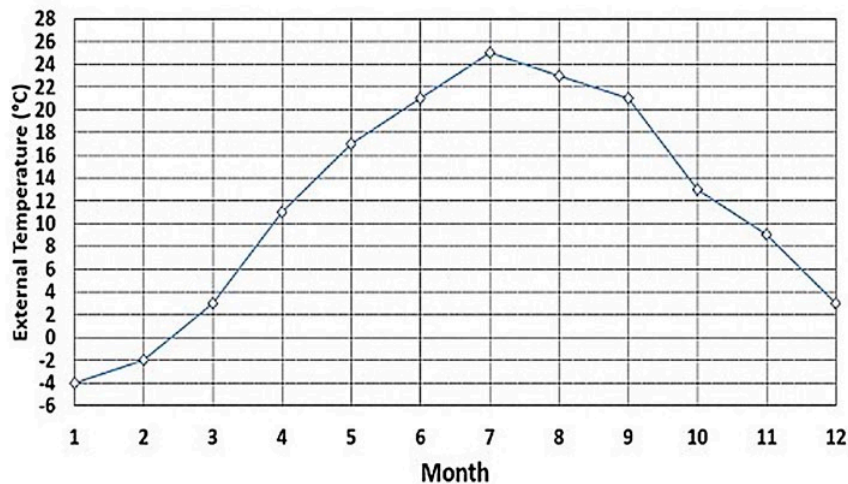

Figure 8. External Temperature by Month for Connecticut, USA

The Sefaira systems energy-modeling program revealed the temperature by room, by season, based on the average external temperature (Table 2). During the winter months, the average temperature in all rooms maintained an average temperature of 14°C (57°F). While this temperature is below the study comfort level, by a few degrees, the researchers believe that with added clothing or additional heat, any of the rooms could be brought up to an acceptable comfort standard. In turn, the analysis revealed that three spaces, the kitchen (2P01), the southwest front room (2P04), and the front room on the second floor (3P03) all reached an internal temperature of $+22^{\circ}\text{C}$ ($+72^{\circ}\text{F}$). The cooking fire in the kitchen accounts for this room's increase in local temperature, while solar gain throughout the day accounts for the increased temperature in the southwest rooms. The indoor temperatures in these three spaces are above our study winter comfort level of $15\text{--}20^{\circ}\text{C}$ ($59\text{--}68^{\circ}\text{F}$), and within a current comfort level of $22\text{--}25^{\circ}\text{C}$ ($72\text{--}77^{\circ}\text{F}$). The thermal environment of most of the spaces in the building tends to be cooler than the thermal environment of non-historic buildings. Therefore, while additional resources could be expended to make only one room within the house habitable, it is more likely that the cluster plan arrangement provided for a reduced living space during the winter months, with two or three rooms serving the needs of the entire family. Other spaces could be closed off, or accessed on a temporary basis, as needed. These results support the initial hypothesis of a modified winter habitation footprint.

Additionally, during periods of the extreme drop in temperature, below $-10\text{ }^{\circ}\text{C}$ ($14\text{ }^{\circ}\text{F}$), residents may have taken shelter in the basement room, where the surrounding ground would have maintained an average temperature of $8\text{--}15\text{ }^{\circ}\text{C}$ ($46\text{--}59\text{ }^{\circ}\text{F}$) [USDA, 2018]. While the basement was not designed to support daily habitation, it did provide a “safe space” during harsh winters, especially if firewood became scarce or unobtainable. With additional clothing, blankets, and shared body-heat, Colonial settlers could easily survive underground for a day or weeks with little or no heat.

Through the spring and fall seasons, the room temperatures ranged from $14.4\text{ }^{\circ}\text{C}$ ($58\text{ }^{\circ}\text{F}$) to $21.4\text{ }^{\circ}\text{C}$ ($76\text{ }^{\circ}\text{F}$) and generally fell within the Colonial comfort level of $15\text{--}20\text{ }^{\circ}\text{C}$ ($59\text{--}68\text{ }^{\circ}\text{F}$). The findings supported the study hypothesis that during these six months, the entire house could be used for habitation, with only a modest need to ventilate or heat individual spaces. Additionally, these temperature changes could also be easily addressed by inhabitants with the simple addition or subtraction of clothing.

Table 2. Data Analysis: Interior Temperature by Room during Seasons

Variables/Spaces	P01 (Floor 2) Kitchen	P02 (Floor 2) Parlor	P03 (Floor 2) Entry & Stair	P04 (Floor 2) Hall	P05 (Floor 2) Pantry-Bdrm	C01 (Floor 2) Chimney	P02 (Floor 3) SE Bdrm	P03 (Floor 3) SW Bdrm	C01 (Floor 3) Chimney	External Weather
Average Temperature ($^{\circ}\text{C}$) Jan. – Dec. (Winter)	23.4	14.9	14.1	22.2	14.2	14.2	23.4	14.2	14.2	-1.3
Average Temperature ($^{\circ}\text{C}$) March – May (Spring)	22.1	15.2	14.4	21.1	14.6	14.5	22.1	14.7	14.6	10.0
Average Temperature ($^{\circ}\text{C}$) Jun. – Aug. (Summer)	30.8	26.7	24.2	27.8	24.1	25.5	30.6	24.3	24.2	23.0
Average Temperature ($^{\circ}\text{C}$) Sept. – Nov. (Fall)	21.4	15.1	14.8	20.6	15.1	14.5	21.6	15.0	14.9	14.0

Through the spring and fall seasons, the room temperatures ranged from $14.4\text{ }^{\circ}\text{C}$ ($58\text{ }^{\circ}\text{F}$) to $21.4\text{ }^{\circ}\text{C}$ ($76\text{ }^{\circ}\text{F}$) and generally fell within the Colonial comfort level of $15\text{--}20\text{ }^{\circ}\text{C}$ ($59\text{--}68\text{ }^{\circ}\text{F}$). The results supported the study hypothesis that during these six months, the entire house could be used for habitation, with only a modest need to ventilate or heat individual spaces. Additional, these temperature changes could also be easily addressed by inhabitants with the simple addition or subtraction of clothing.

During the summer months, July-August, the external temperature range was usually from $21\text{--}25\text{ }^{\circ}\text{C}$ ($70\text{--}77\text{ }^{\circ}\text{F}$), with July being the hottest of the months, with

an average temperature of 23 °C (74 °F). However, it was common for extreme temperatures to reach 35 °C (95 °F) during periods of the month. Utilizing a thermal comfort level of 22–25 °C (72–77 °F), the entire house was analysed for daily habitation. The analysis revealed that all the rooms except the entry, pantry, and southwest bedroom averaged between 24 °C (75 °F) and 26 °C (79 °F), with mean temperature at or above the comfort level (Figure 9). The kitchen with its cooking fire, and the southeast sleeping room with its prolonged sun exposure, both averaged above 30 °C (86 °F). As such, during July, the interior of the house was often uncomfortable and not conducive to daily activities. This situation lends credence to the need for a “summer retreat” in front of the house, a clearing created by planting deciduous shade trees. The trees shaded both the south side of the house and its landscape. When it became uncomfortable inside, furniture was moved outside, and regular activities continued unimpeded. To reduce the interior heat, outdoor “kitchens” allowed for cooking without increasing interior temperatures. In the evening, the temperatures would have cooled some, allowing the settlers to move back inside and comfortably sleeping throughout the night.

In this way, the design of the Saltbox is not merely the building itself, but also the immediate and surrounding landscape.

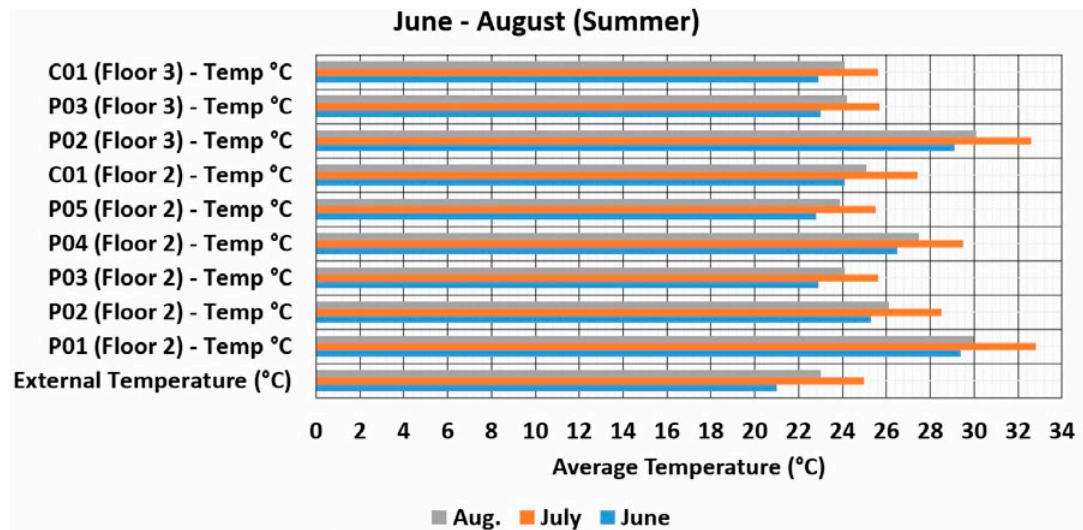

Figure 9. Data Analysis: Interior Temperature by Room in the Summer Months.

In a similar manner to the extreme temperatures in winter, if extreme temperatures in summer became unbearable, the settlers could once again retreat to the basement and sleep comfortably. With an average temperature of 8–15 °C (46–59 °F) [USDA, 2018], this space would be a cool alternative to the hot and humid sleeping rooms above. It is interesting to note, that as utilities (firewood or coal) became more available and abundant, many families refrained from building basements or constructed only small “root cellars.” Whether this is due to construction costs or social status is not known, but as the Saltbox became a preferred prototype, fewer and fewer Colonialists constructed basements.

5.1 LIMITATIONS

While the Sefaira energy modeling software was utilized for this analysis, the program did not allow consideration of the chimney mass and the heat distribution by individual fireplaces. Additionally, it did not allow for a full analysis of the natural ventilation throughout the building, nor during various calendar months. Finally, the software did not enable us to consider the temperature-moderating effects of the earth's immense thermal mass realized by the basement rooms, which would have provided an alternative heat source or habitat during extremely cold and hot temperatures.

To overcome the limitations, the researchers have recently garnered a University of Hartford Coffin Grant to purchase a license for the computer software program DesignBuilder by EnergyPlus needed to conduct further scholarly research work on structural/mass timber and sustainable buildings. The software is a state-of-the-art tool for analyzing building environmental performance including energy, carbon, lighting, comfort, and cost performance of buildings under different weather scenarios. By running additional computer simulations, the researchers hope to refine the building's environmental performance analysis, including the daylighting, temperature swings, relative humidity, thermal mass, carbon emissions, and more refined comfort levels of the entire building. Additionally, the new software allows for the consideration of current and future weather scenarios. For instance, with the provision of the software and the appropriate weather files, the researchers can conduct weather simulations, for extended periods or specific situations.

6. CONCLUSIONS

The researchers speculate that with limited utility resources (heat or ventilation), most Colonial settlers, out of necessity, accepted a wider range of temperature in their comfort level than we do today. Additionally, layers of dress, traditional at the time, allowed for a simple modification of individual comfort. The Saltbox plan provided for many rooms clustered around the thermal mass of the fireplace, which provided direct and borrowed heat to individual rooms. While not a large residence, the five spaces generally allowed for a distribution of activities and some level of personal privacy. However, during times of extreme temperatures, Colonial settlers found it necessary to reduce their habitable footprint, retreat underground, or move outside. A finely tuned machine for living, the Saltbox house provided multiple means of modification with doors and windows organized for both isolation and aligned cross ventilation. Direct solar gain at various times of the year, served as both an asset and disadvantage. Shading via roof and floor overhangs, along with tree foliage modified some solar gain in summer. As such, the orientation, location, and landscape related to the house were all essential components of the overall function and passive solar design. While many aspects of the building's passive design would still be available on any building lot, the ideal site added considerably to the building's sustainability.

In conclusion, it is evident from this study that the New England Saltbox house is a very sustainable structure, providing a flexible plan arrangement while being

able to respond to extreme shifts in weather and temperature. With its intrinsic ability to provide comfortable shelter, it would naturally become the precedent for European immigrants settling throughout New England. In many ways, the Saltbox can still serve as a precedent today. Contemporary homebuilders could utilize the intrinsic passive solar design characteristics of the model, modernize the plan, and enhance it with recent technology and material innovation. In this way, what was once old, can and will be new again.

7. REFERENCES

- [1] Fabbria, K., Brunetti B., The attic and its effect on the energy performance of historic building. 6th International Building Physics Conference, IBPC 2015. Energy Procedia, 2015.
- [2] Karam M. Al-Obaidi, Mazran Ismail, Abdul Malek Abdul Rahman. A review of the potential of attic ventilation by passive and active turbine ventilators in tropical Malaysia. *Sustainable Cities and Society* 10, pp. 232–240, 2014.
- [3] Dimoudi, A, Androutsopoulos, A, Lykoudis, S. Summer performance of a ventilated roof component. *Energy and Buildings* 38, pp. 610– 617, 2006).
- [4] Bock, Gordon. "Saltboxes and catslides (1660–1800)." *Old House Journal*, vol. 29 no. 6, pp. 64–67, Nov./Dec. 2001.
- [5] "Affordable Saltbox." *Builder*, vol. 24 no. 11, p. 46, Aug. 15, 2001.
- [6] Philbrick, N., *Mayflower: A story of courage, community and war*, New York, NY: Viking Penguin, 2006.
- [7] Colkert, M.B., Jr., *Founders of early American families: Emigrants from Europe 1607–1657*, Cleveland, OH: The Founders and Patriots of America, 1985.
- [8] Nervill, R., *Old cottage and domestic architecture in south-west Surrey*, Guilford: Billing and Sons, 1889.
- [9] Garvan, A.N.B., *Architecture and town planning in Colonial Connecticut*, New Haven, CT: Yale University Press, 1951.
- [10] Newcomb, R. & Foster, W.A., *Home architecture: A textbook for schools and colleges, a manual for the home builder and home owner*, New York, NY: Wiley & Sons, Inc., 1932.
- [11] Alsop, Susan Mary. "American continuity: Remembering William Sheffield Cowles at Oldgate." *Architectural Digest*, vol. 43, pp 170–175, Sept. 1986.
- [12] Baker, J.M., *American house styles: A Concise Guide*, New York, NY: Norton & Company, 1994.
- [13] Walker, L., *American homes: The landmark illustrated encyclopaedia of domestic architecture*, New York, NY: Black Dog and Leventhal Publishers, Inc., 1996.
- [14] Shelton, J.D.F., *The Saltbox house: Eighteenth century life in a New England hill town*, New Haven, CT: Baker and Taylor, 1901.
- [15] Pollard, Mark. "American Archetype: Always in Style." *Classic American Homes*, vol. 26 no. 3. p 102, June 2000.
- [16] DeKay, M. & Brown, G.Z., *Sun, wind & light: Architecture design strategies*, New York, NY: Wiley & Sons, Inc., 2014.

- [17] Sawruk, T. Historically Sustainable: Natural Ventilation in Connecticut Houses of the 1600s and 1700s. In *Proceedings of the Advanced Building Skins Conference*, Bern Switzerland, 2017.
- [18] <http://sefaira.com/sefaira-architecture/>
- [19] United States Department of Agriculture (USDA). *Natural resources conservation service, Connecticut: CT Soils-Winsor*. (Gov. Website) Retrieved from: https://www.nrcs.usda.gov/wps/portal/nrcs/detail/ct/soils/?cid=nrcs142p2_011143 [February 25, 2018]

Note

The following Figures were obtained from Isham, N.M. & Brown, A.F., *Early Connecticut Houses: An Historical and Architectural Study*, Providence, RI: Dover Publications, Inc., 1965, originally published by The Preston and Rounds Company, 1900: Figures 1, 2, 3, 4.

It's not the end of the World (Heritage Site)

Impacts of an energy savings programme on historical values in Visby, Sweden

M. Legnér and M. Tunefalk

Conservation Unit, Department of Art History, Uppsala University – Campus Gotland, Visby, Sweden.
Email: mattias.legner@konstvet.uu.se; martin.tunefalk@konstvet.uu.se

Abstract – The purpose of this paper is to investigate the practical impact of the 'Energy savings plan for existing buildings' (EBB) on the historical values of the built environment in Visby, Sweden. The EBB, active 1977–1984, has been generally criticized for its negative impact on historical values. The paper nuances this image by comparing changes in the built environment during and after the time the EBB. The aim is to contribute to a wider understanding of changes in the built environment in the historical inner city of Visby, and to relate changes in the built environment to the EBB. The paper concludes that EBB had little impact on the historical values of the studied area. Change has been an inherent part of the area both prior to, during, and after the EBB, but the rate and impact has increased since the 1980's.

Keywords – historical values; energy efficiency; policies; Visby; world heritage

1. INTRODUCTION

1.1 PURPOSE AND AIMS

The Energy savings plan for existing buildings (*Energisparplan för befintlig bebyggelse*, EBB), was the first national programme for energy efficiency in buildings in Sweden, in effect 1977–1984. In order to improve the energy performance in the building stock, loans and grants were issued to home owners for measures such as additional thermal insulation, triple glazing windows, more efficient heating systems, etc. The EBB has been criticised for resulting in to extensive refurbishments, thus diminishing cultural values in the built environment. [1]

This paper sets out to compare the impact of changes in the built environment during and after the EBB. The case study is part of the World Heritage Site of Visby in Sweden, an area recognized for its sensitive and appreciated historical values. It is a first attempt to compare the impact of the EBB policies on the values in the studied area with later modifications of buildings. There is today a belief that EBB had a profound and negative impact on the exterior of buildings in urban areas. This study will ask to what extent this belief actually corresponds with the real situation, and investigate the extent of impact and rate of changes occurring. Furthermore, it will put EBB supported interventions in relation to additions, renovations and new constructions that occurred without EBB support in the period 1977–2015. The aim is twofold. First, it is to more generally contribute to a wider understanding of the changes that the built environment in the historical inner city of Visby has undergone. Second, it is to relate changes in

the built environment to the EBB and try to better understand the contexts within which such policies have to function in practice.

1.2 DELIMITATIONS

In order to make such an investigation feasible for the scope of a conference paper, some delimitations are necessary to make. The study is limited to one block, *Berget*, in intramural Visby. The impact on historical values can better be assessed by studying one cohesive block rather than scattered buildings. Changes in the environment are limited to exterior modifications subjected to building permits. There have of course also been other, minor changes that have not required permits. Typical modifications requiring a permit have been considerable changes of doors, windows, roofs, façades, extensions, and construction. All these modifications may affect the historical values of the buildings in themselves, and in extension, of the whole block and even the world heritage site (WHS) in its entirety. Temporally, it is limited to changes taking place between 1945 and 2015. For the time prior to the EBB, a general survey has been done using a report from 1974 [2].

2. METHODOLOGY AND SOURCES

The study was carried out in five steps. Firstly, archival studies of the municipal archive of building permits were carried out in order to find approved exterior alterations to buildings since 1977. This allows us to see both what has been done in the area and to date the alterations. Secondly, we have carried out ocular observations of the current state of buildings, in order to find out whether approved alterations have actually been carried out, and to make sure no major exterior alterations were carried out without the knowledge of the municipality. By using these two methods we obtain a more or less complete history of changes in the built environment. The third step has been to find out whether alterations made in 1977–1984 can be derived from the EBB. This is done using the archive of the regional housing committee (länsbostadsnämnden). This committee handled the subsidies and loans included in the programme. By using these methods, the vast majority of exterior modifications can be traced, dated and at least in some cases associated with EBB. For changes prior to the EBB, a general survey of exterior modifications of buildings in intramural Visby between 1945 and 1975 was done using a report produced in 1973. This period is not included in the quantifications. Finally, the rate and nature of changes in the built environment, prior to, during, and after the EBB, were compared and analysed.

Modifications to buildings have been classified as having small, moderate, or large impact on the environment. Small impact includes exchange to building elements similar to the previous, e.g. new doors, façades, or roofs in the same style and material, as well as changes not seen from the street. Moderate impact includes adding new windows and doors, changing existing windows and doors to new ones, minor extensions of the building area, and new colour of windows and doors that deviated from previous styles and materials and are seen from the street. Large impact includes construction of new buildings, demolition

of buildings or larger parts of buildings, substantial extensions of the building area, new façade material or significantly new colour, and modified slope of roofs or new roof material, all seen from the street. Of course, larger measures such as extensions also include other smaller measures, such as new windows and façades. Such accompanying measures are not accounted for in the quantifications.

The compared time periods differ in length. The duration of the EBB was eight years, compared with later ten-year periods. Since the study concerns long-term processes, the exact year of a change is of small relevance. Rather, the aim is to detect if the period of the EBB significantly stands out in comparison with later years. Of course, other factors are at play, and changes can be related to other causes, including other policies and programmes. However, the purpose of the comparison is not to derive changes to the EBB, but to demonstrate the forces at play that impact historical values in the urban environment. If changes can be connected to other influences, it only strengthens this argument.

3. THE BLOCK “BERGET” IN VISBY

Located in the southern part of intramural Visby, *Berget* is an irregular block of 29 lots (out of a total of 973 lots with 1,958 buildings) with buildings from the 18th to the 21st century. It constitutes one of the bigger blocks in the old city. As in other parts of intramural Visby, there are considerable historical values. Parts of the block were built-up in medieval time, and some graves that belonged to the two medieval cemeteries just north of the block have been found. It was first planned in the mid-17th century, but most likely nothing from that time remains except for the shape and size of the block. The block is divided by a steep cliff, with the larger part of the block located below the cliff. On the cliff there has historically been smaller wooden houses, and below there have been more well-off households with masonry houses. This difference in building style is still today visible. The northwest part, located beneath the cliff, runs along *S:t Hansgatan*, which was the most attractive street in town in the 19th century. This part of the block is dominated by larger 19th and 20th century buildings (the most recent from the 1970s and 1980s), but there are also four buildings from the 18th century. The southeast part of the block, on top of the cliff, stretches along the square *Kinbergs plats* and the narrow street *Björngränd*, and is dominated by small 18th century houses. In the north, the houses are larger and most of them from the 19th century, except for a large residential building erected in 2007. [3]

The area is relevant to study because of its location within the world heritage site of Visby, for its architectural diversity, and because it has a large number of lots. The status of WHS makes the area especially sensitive to major exterior alterations of buildings. Understanding and interpretation of historical values are likely to be more explicit in such an area. The fact that the buildings vary greatly in size, character and age contribute to a generalizability that would not be possible in an area with uniform architecture.

4. THE ENERGY SAVINGS PLAN FOR EXISTING BUILDINGS

The EBB programme was launched in may 1978 with the aim of reducing the energy use in buildings by 25–30 percent in ten years. The incentives for energy saving went back to the oil crisis of 1973–74. The EBB consisted of loans and grants to home owners for implementing energy efficiency measures to their buildings. Just in the first year, a total of 54,000 buildings were granted support for additional thermal insulation, new heating systems, new windows and doors, etc. The total number of grants is not known, but in Visby alone 706 grants were processed in 1977–1984, including exterior and interior changes. The funding was allocated by regional housing committees, but in general substantial exterior measures needed building permits handled by the municipalities. There were however exceptions, such as when a façade was re-plastered after insulation had been added. The programme also comprised information to homeowners, including promotion of additional façade insulation, a measure that normally would have a major impact on the appearance of the building. In 1983, an extensive home improvement programme was launched. Aims of energy efficiency were then incorporated into this programme, and the EBB was cancelled. [4]

5. CHANGES PRIOR TO THE EBB

In the early 1970's there were roughly 900 properties with 1,300 buildings in intramural Visby. Since 1945, there was a trend towards modernization and sanitation of residential buildings. Between 1945 and 1971 half of the building stock was subjected to modifications requiring building permits. 420 buildings were modified substantially and 70 were completely new. In 1960, a third of all residential units (RUs) lacked central heating, half of them lacked bathtub or shower, and 25 percent lacked WC. In the 1960's, national policies aimed to reduce the number of 'unmodern' RUs considerably. Between 1960 and 1970 the number of unmodern RUs decreased from 500 to 150 in intramural Visby. This did not mean that 350 units had become fully modern, but that one or more measures had been taken, such as the installation of central heating. At the same time the number of RUs decreased by 10 percent and the population of the area went down from 3200 to 2600. [5]

There was a certain degree of awareness that this process of sanitation had implications for the built heritage. The biggest exterior change that took place was probably a massive introduction of dormer windows where there had not been any before. Refurbishment often mean that attics were furnished in order to increase living space. Dormer windows were installed to allow daylight. Other common changes were modified slopes of roofs, extensions into the courtyards and raising of the floor beams. One conclusion of the report was that it was difficult to determine how the cityscape was affected by these modifications, which were both numerous and heterogeneous.

To sum up, as a consequence of policies encouraging technical upgrading of RUs, there was quite a lot of retrofitting carried out in the period 1945–1975, but it is uncertain to what extent historical values were affected. Included in the

policies for sanitation of RUs was the aim that central heating should replace local fireplaces. It is however not known how many central heating systems were installed or how the use of energy was affected by this.

6. CHANGES DURING AND AFTER THE EBB

As demonstrated in Table 1, the rate of impact on the exterior of buildings in the period of the EBB was low (between c. 1/3 and 1/6) compared with later periods. Only two measures subjected to building permits were carried out in the period 1977–1984. However, both of these are considered to have had a large impact on the built environment in the area. They consist of one extension on Berget 14 in 1977 (Dnr 1977-00900) and one construction, a garage and laundry in Berget 25 in 1980 (Dnr 1980-0328). But even though these measures had a large impact on the environment, they were not results of the EBB, since they neither were subsidized by the programme, nor had any energy savings incentives.

Table 1. External measures in Berget, Visby, 1977–2015.

Period	Impact on the built environment			Total	Yearly average
	Small impact	Moderate impact	Large impact		
1977–1984 (EBB)	0	0	2	2	0.25
1985–1994	6	2	3	11	1.1
1995–2004	5	0	3	8	0.8
2005–2015	9	5	3	17	1.55
Total	20	7	11	38	0.97

Source: Building permit archive in Gotland regional archive (Arkivcentrum Gotland).

In 1985–1994, the most important change to the area was the construction of a multi-family dwelling in *Berget 23* in 1986, which had a significant impact on the environment and created a denser habitation in the area around the ruin *St Hans* (Dnr 1986-0032). This construction probably also had the largest impact on the energy use in the area. Other measures with effect on the environment included installation of ten dormer windows (Dnr 1985-0183), and the construction of a storage and shelter in *Berget 23* in 1980 (Dnr 1985-0183), an extension of the main building in *Berget 13* (Dnr 1987-0181), demolition of a vestibule in *Berget 7* (Dnr 1990-0283), new roof material in *Berget 17* (Dnr 1990-0392), addition of an external staircase in *Berget 19* (Dnr 1992-0329), construction of a small house in *Berget 19* (Dnr 1992-0938), and new windows and altered façade on *Berget 20* (Dnr 1994-0316).

Measures in 1995 to 2004 included new doors and windows, extension and new façade, as well as construction of a garage on *Berget 16* (Dnr 1997-0192, 1999-0440), a new balcony on *Berget 3* (Dnr 2001-0457), changing of windows and a new dormer window in *Berget 6* (Dnr 2002-1209), and an extension of *Berget 13* (Dnr 2001-1166).

In 2005–2015, no doubt the most conspicuous measure in the area was the construction of a large, multi-family dwelling on *Berget 24*, in the north-east (Dnr 2003-1097, 2006-1714). Where there previously had been a parking lot and a three-car garage, was in 2007 erected an apartment building covering the entire area of the property, the largest construction project in intramural Visby since the early 1970's, according to the county museum. [23] The building was consciously designed as to fit the environment, and even has features simulating alterations to the building (such as sloop of roof that suggests an extension to the yard and different levels and materials of the roof), since such measures so strongly have influenced the surrounding environment. This was considered positive by the museum. Nevertheless, the building constitutes a significant alteration to the area; where previously there was an open space with a view over the old town and the sea, is now a densely built street scene.

Another property subjected to extensive retrofits was *Berget 25*, in the south of the block. The exterior implications of these retrofits were a new sloop of roof, new roof material, new façade colour, an added *frontispiece*, and a large number of (in some case very big) windows (Dnr 2007-1423, 2007-1728). Other measures in the area included extensions of *Berget 2* (Dnr 2009-0470) and 3 (Dnr 2005-0511), construction of a greenhouse in *Berget 23* (Dnr 2005-1478) and a guest house in *Berget 6* (Dnr 2012-2029), demolition and construction of a garage (Dnr 2006-1449) and new façade colour on the main building (Dnr 2012-2086) in *Berget 6*, new windows and roof in *Berget 18* (Dnr 2013-477, 2013-1898), and a new garage gate in *Berget 21* (Dnr 2015-6253). In regard to energy use, the extensions and the large construction on *Berget 24*, of course meant a larger heated area. Added windows, primarily in *Berget 25*, meant an impaired insulation.

None of the measures from 1977–1984 in the building permit archive received subsidies from the EBB. During the period, a total of eight energy savings loans were approved for properties in the area. The information is scarce, but we have been able to derive two measures to these loans that affected building exteriors. In 1978, *Berget 16*, today a listed building, received funding for additional

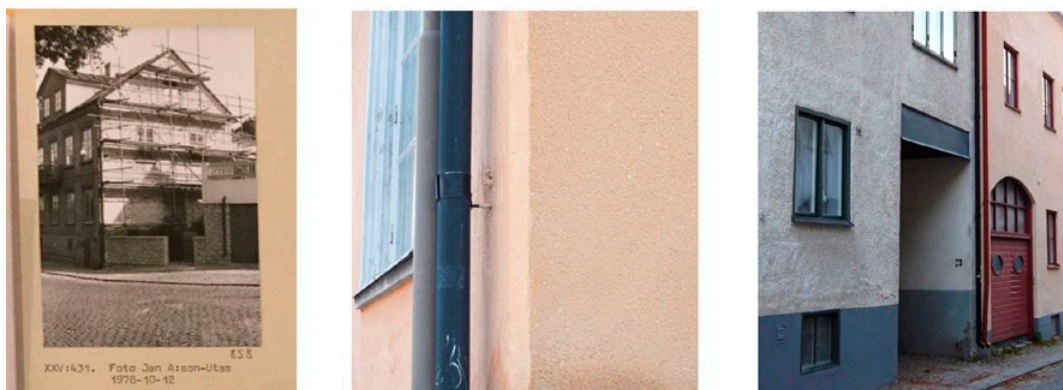

Figure 1. Two measures to exterior of houses derived from the EBB: additional façade insulation in *Berget 16* (left and middle) and additional insulation of the system of joists (right). Photos: Mattias Legnér.

Table 2. External measures to buildings in Berget, Visby, 1977–2015

Year	Property	Measure	Impact	Reference
1977	Berget 14	Extension	Large	1977-00900
1980	Berget 25	Construction of garage and laundry	Large	1980-8328
1985	Berget 23	Construction of shelter and storehouse	Large	1985-0183
1985	Berget 23	Installation of ten dormer windows	Moderate	1985-0183
1985	Berget 23	Installation of new windows	Small	1985-0183
1986	Berget 23	Construction of multi-family residence	Large	1986-0032
1987	Berget 13	Extension	Large	1987-0181
1990	Berget 7	Demolition of vestibule towards the yard	Small	1990-0283
1990	Berget 17	New roof material towards the yard and on courtyard house	Small	1990-0392
1992	Berget 19	Extension (staircase towards the yard)	Small	1992-0329
1993	Berget 19	Construction of courtyard house	Small	1992-0938
1994	Berget 20	Installation of new windows	Small	1994-0316
1994	Berget 20	Alteration to façade (plaster over the base etc.)	Moderate	1994-0316
1997	Berget 16	Change of doors	Small	1997-0192
1997	Berget 16	Change of windows	Small	1997-0192
1997	Berget 16	Extension	Large	1997-0192
1999	Berget 16	Construction of garage	Large	1999-0440
2001	Berget 3	Change to new balcony to the courtyard, incl. new glass door	Small	2001-0457
2002	Berget 6	Installation of a dormer window to the yard	Small	2002-1209
2002	Berget 6	Change of windows towards the yard	Small	2002-1209
2002	Berget 13	Extension	Large	2001-1166
2005	Berget 3	Extension to the yard, incl. new large windows	Small	2005-0511
2006	Berget 23	Construction of greenhouse	Small	2005-1478
2006	Berget 24	Demolition of garage	Large	2006-1714
2007	Berget 6	Demolition and construction of garage (supplemental)	Small	2006-1449
2007	Berget 25	Altered shape and new material of roof	Large	2007-1423
2007	Berget 25	Demolition of vestibule to the yard	Small	2007-1728
2007	Berget 25	Installation of new windows	Moderate	2007-1423
2007	Berget 25	Construction of a brick garden wall	Moderate	2007-1423
2007	Berget 25	Installation of new door	Moderate	2007-1423
2007	Berget 24	Construction of a multi-family residential house	Large	2003-1097
2009	Berget 2	Extension to the yard	Small	2009-0470
2011	Berget 8	Change of brick garden wall (supplemental)	Small	2010-868
2012	Berget 6	Construction of guest house in the yard	Small	2012-2029
2012	Berget 6	New façade colour to the yard	Small	2012-2086
2013	Berget 18	Changing of windows	Moderate	2013-477
2013	Berget 18	Reroofing (similar style)	Small	2013-1898
2015	Berget 21	Changing of garage gate	Moderate	2015-6253

insulation on the southern façade. Photographic material from the time show the work in progress. Today, the additional insulation is clearly visible and the plaster differs from the rest of the building (Figure 1). The same year, *Berget 19* received funding for additional insulation of the system of joists. The measure is clearly visible in form of a metal sheet covering the lower joists in a gateway to the yard (Figure 1). That only two external measures have been derived point to the EBB having an insignificant impact on the environment. But the two examples also demonstrate that somewhat extensive measures to buildings' exteriors could be carried out without a building permit. Probably more so during the earlier period of the investigation, since the measures demanding permits increased with the rising interest in the historical values in Visby, most noticeable after the designation to WHS in 1995.

7. DISCUSSION

There have been some transformational changes to the area, particularly the construction of a few bigger buildings. But mostly, the environment is characterized by gradual alterations, each one of minor importance to the character of the area, but put together they make a significant impact. Few of the documented measures have directly targeted energy efficiency, but most changes, e.g. extensions, new roofs and new windows, have effect on the overall energy consumption. A conclusion from this study is that, even in a protected and culturally highly valued area such as the WHS of Visby, buildings and areas continuously change over time and the rate even seems to pick up over the course of time. The notion of an area preserved from an era and kept the same for future generations, is often problematic. Change is an inherent feature of the urban environment.

Perhaps surprising, the rate and impact of measures changing the built environment in the area, have not decreased as interest had increased in Visby's historical values. In the last years, this part of the WHS experienced more changes than in previous decades. This can partly be explained by the fact that building permits are required for measures that previously did not need one. The extent of the changes in more recent years suggests that renovations have become more extensive over time. It is likely that this is caused by increasing property values in the inner city. Property owners who have invested a lot of capital, tend to wish to make additional investments in order to 'improve' their property.

In *Berget*, the EBB has proved to have had an insignificant impact on the built environment. The years of the programme actually stands out as a period with significantly less major changes to the environment. It is likely that larger investments to buildings were hindered by the slow economy, particularly in the housing sector, at the time. The largest construction programme in Sweden's history (*Miljonprogrammet* 1965–1975) had ended just before the programme was introduced, leaving a surplus of RU's. The most intense period of sanitation of housing had also come to an end. Combined with a generally slow economy, this lead to few further investments in the sector.

Nevertheless, the prevailing notion among architects and building conservators has so far been that the EBB had a large negative impact on the built environment. Our own studies of an area in the Swedish town Gävle, has shown that external measures such as additional insulation were common during the EBB. This paper nuances these results and points to local or regional differences. One explanation for e.g. additional thermal insulation being common in Gävle but not in Visby, is the difference in climate. The two cities are located in different climate zones, with Visby having significantly higher winter temperatures. Another explanation is that historical values, in comparison with values of decreased energy use, were valued higher in Visby, by the municipality and/or the citizens. Additional research is needed to clarify the causal relationships.

8. ACKNOWLEDGEMENTS

The authors wish to thank Malin Stengård for having retrieved information about EBB support from the archive.

9. REFERENCES

- [1] Antell, O. and Paues, C. *Isolering uppåt väggarna*. Stockholm: Byggforskningsrådet 1981.
- [2] *Visby: Staden inom murarna*, Visby: Kommittén för planering av Visby innerstad 1974.
- [3] *Visby innerstad. En bebyggelseinventering*, del 2. 2003, p. 181.
- [4] Légner, M. and Leijonhufvud, G. "A legacy of energy saving: The discussion on heritage values in the first programme on energy efficiency in buildings in Sweden, c. 1974–1984", paper submitted to *The Historic Environment: Policy & Practice*.
- [5] "Visby. Handlingsprogram för staden inom murarna" (copy of manuscript kept in the Gotland Museum library), Visby 1973, Appendix 7.
- [6] Assessment by Gotland Museum regarding Berget 24, 2003-10-21. Dnr 2003-1097.

Examining the energy performance of older and historic buildings using municipal benchmarking data

A.L. Webb, L. Beckett and M.D. Burton

Department of Civil and Architectural Engineering and Construction Management, University of Cincinnati, Cincinnati, OH, USA. Email: amanda.webb@uc.edu

Abstract – Until recently, nationally representative survey data has been the primary source of information on the energy performance of buildings in the U.S., relative to their year of construction. The emergence of municipal energy benchmarking ordinances and public availability of benchmarking datasets now makes it possible to explore these relationships at the local level, and to link this data with information about a building's historic designation status. This paper presents results from an initial statistical analysis examining the relationships between building energy use, year of construction, and historic designation status. First, municipal benchmarking data from six U.S. cities is used to examine local trends in the relationship between building age and energy performance. Second, an exploratory analysis of the energy performance of designated historic compared to non-historic buildings in New York City is presented. The methods described in this paper could be applied more widely to benchmarking datasets from other cities.

Keywords – energy benchmarking; energy use intensity (EUI); year of construction; listed historic buildings; linear regression

1. INTRODUCTION

Over the past decade, an increasing number of U.S. cities have adopted legislation requiring building owners to disclose and benchmark their energy consumption on an annual basis. The scope of these policies are similar from city to city, targeting large commercial and multifamily residential buildings – typically those greater than 50,000 ft² (4,645 m²) – and including some form of transparency, in which the benchmarking data is made publicly available [1]. Owners are required to report energy consumption based on 12 months of utility bills, and submit other descriptive information such as building type, floor area, and year of construction. Whereas previous work examining the relationship between year of construction and building energy performance in the U.S. has been based largely on nationally representative data [2], these new municipal benchmarking datasets provide an opportunity to identify local trends in the energy performance of older and historic buildings.

Existing analysis of the relationship between year of construction and building energy performance using municipal benchmarking data has been limited to official annual reports issued by the cities. Palmer and Walls [1] summarize these reports; they find that data for Washington DC, Minneapolis, Chicago,

and Philadelphia show no relationship between site energy use intensity (EUI, computed by normalizing annual energy consumption by floor area) and year of construction, but in New York and Boston older office type buildings have a lower EUI than newer ones. However, the findings in these reports are limited to graphical trends and do not provide statistical analysis. Kontokosta [3] does provide statistical analysis of the 2012 benchmarking data for New York, including year of construction and historic designation status in multiple regression models for office and multifamily residential buildings. The analysis showed that, using the natural log of source EUI as the response variable, the two oldest age categories of buildings were statistically significant predictors for both building types, with older buildings having lower EUIs.

In contrast to previous work, the present study provides statistical analysis of the relationship between year of construction and EUI for multiple U.S. cities, allowing for comparison of trends. The present study also moves beyond year of construction, examining the energy performance of designated (listed) historic buildings at both the local and federal designation level.

2. DATA AND METHODS

2.1 MUNICIPAL BENCHMARKING DATA IN THE U.S.

Municipal benchmarking data was downloaded from the U.S. Department of Energy (DOE) Building Performance Database (BPD) [4]. The datasets contain information on a range of variables for each benchmarked building, including annual metered energy consumption, building address, building type, and year of construction. They include both the raw benchmarking data submitted to DOE by the city, and a version cleansed by DOE; the cleansed versions were used for this study. As of September 2017, data for seven cities was available for download: Boston, Chicago, Minneapolis, New York, Philadelphia, San Francisco, and Washington DC. The data for New York and San Francisco did not contain information on a building's year of construction, but benchmarking data for New York was matched with records in New York City's Property Land Use Tax Lot Output (PLUTO) database [5] to obtain information on year of construction, resulting in datasets for six cities that could be analysed in this study. Energy consumption in the benchmarking data was from the calendar year 2014 for all cities except New York and Washington DC, which contain data from 2013.

2.2 RECORD LINKAGE WITH LISTED HISTORIC BUILDINGS

The municipal benchmarking data does not contain information about whether a building is a designated historic building. However, the benchmarking data does contain street addresses for each building, which were then matched with street addresses in auxiliary databases to determine a building's historic designation status. New York had the best available auxiliary data on historic designation, so this matching process was only completed for the New York benchmarking data.

Three auxiliary databases were used to provide information about historic designation for buildings in the New York benchmarking data: the PLUTO database,

the National Register of Historic Places (NRHP) [6], and the New York State Cultural Resource Information System (CRIS) [7]. The PLUTO database provided information about a building's local designation status, i.e., whether a building was a designated historic landmark or located within an historic district designated by the New York City Landmarks Preservation Commission (LPC). The NRHP database provided information about a building's individual federal designation status, i.e., whether a building was individually listed on the NRHP. The CRIS database provided information about a building's federal district designation status, i.e., whether a building was listed as contributing within a federally designated historic district. A fuzzy string matching algorithm through an add-in in Microsoft Excel was used to perform the address matching.

2.3 ANALYSIS METHODS

Using the benchmarking data for each of the six cities, summary statistics were computed for the two primary variables of interest in this study: site EUI and year of construction. Pearson correlation coefficients were computed to quantify the strength and direction of the linear relationship between the two variables, and simple linear regression models using ordinary least squares were developed to examine the relationship between site EUI and year of construction. The natural log transform of EUI was used as the response variable to address issues of non-constant variance and non-normality of the model residuals, leading to the following regression model form:

$$\ln(y) = \beta_0 + \beta_1 x_1$$

where y is site EUI, x_1 is year of construction, and β_0 and β_1 are the estimated regression coefficients. The estimated regression coefficient for year of construction can be interpreted as representing an $(e^{\beta_1} - 1) * 100$ percent change in mean annual EUI for each one-year increase in a building's year of construction.

To analyse the energy performance of historic vs. non-historic buildings, the benchmarking data for New York, after being matched with PLUTO, NRHP, and CRIS datasets, was divided into six groups:

- *All* – includes all of the buildings in the New York benchmarking data;
- *All Historic* – buildings designated under any of the four types of historic designation below;
- *LPC Historic District* – buildings located within historic districts, as designated by the LPC;
- *LPC Historic Landmark* – buildings designated as historic landmarks by the LPC;
- *NRHP Listed Building* – buildings listed individually on the NRHP;
- *NRHP Contributing in District* – buildings listed as contributing within designated historic districts on the NRHP

Summary statistics were computed for each of the groups. Welch's t-test (unequal variances t-test), which is known to be robust to departures from normality, was

used to test for statistically significant differences in the means of the different groups. The test statistic is given by:

$$t = \frac{(\bar{x}_1 - \bar{x}_2)}{\sqrt{\frac{s_1^2}{n_1} + \frac{s_2^2}{n_2}}}$$

where \bar{x} , s^2 , and n are the means, variances, and sample sizes (less missing data) of the two groups being compared.

3. RESULTS

3.1 RELATIONSHIP BETWEEN YEAR OF CONSTRUCTION AND EUI ACROSS SIX U.S. CITIES

The results of the analysis examining the relationship between building year of construction and EUI are presented in Tables 1–3 and Figure 1.

Table 1 provides summary statistics for the two primary variables of interest: site EUI, and year of construction. The median, mean, and standard deviation values for each variable are provided, along with the number of buildings in each benchmarking dataset (missing values were omitted when computing the summary statistics). Comparing EUI across the six cities, Washington DC has the lowest median EUI, followed by Boston and Philadelphia. Washington DC also has the lowest mean EUI, followed by New York. Note that in all cities the median is lower than the mean, indicating that the distribution of EUI is right-skewed for all cities. While these EUI comparisons do not control for climate, all of these cities are located in relatively similar ASHRAE climate zones (ranging from 4A to 6A). Comparing year of construction across the six cities, New York has the oldest median and mean year of construction, followed by Philadelphia; Washington DC has the newest building stock. Note that in all cities except New York the median is larger than the mean, suggesting that the distribution for year of construction is left-skewed.

Overall, EUI and year of construction appear to be fairly similar across the six cities, and are within typical ranges for the U.S. commercial building stock as a whole. According to the 2012 CBECS data [8], the median site EUI for commercial buildings between 200,001 and 500,000 square feet is 77.1 kBtu/ft² (243.2 kWh/m²) across all climate zones and building types, and 53 % of the U.S. building stock was constructed prior to 1979.

Figure 1 provides kernel density plots for year of construction for each of the six cities. Each line represents a different city; Boston, Chicago, and Minneapolis are plotted together at left, and New York, Philadelphia and Washington DC are plotted together at right. The plots indicate that the distribution of year of construction is multimodal for all six cities, and approximately left-skewed for all cities except for New York. The distributions for Boston, Chicago, and Minneapolis are all fairly similar, with a peak in the early 20th century and a

second peak in the late 20th century. The distribution for Washington DC is shifted to the right (i.e., newer) and the distribution for Philadelphia is flatter and shifted to the left (i.e., older) compared to the other cities. As with Table 1, the similarity between the six cities is notable.

Table 1. Count and summary statistics for site EUI and year of construction by city

City	N	Site EUI, kBtu/ft ² (kWh/m ²)			Year of Construction		
		Median	Mean	Std. Dev.	Median	Mean	Std. Dev.
Boston	1,372	78.2 (246.7)	102.1 (322.0)	88.7 (280.0)	1972	1961	41
Chicago	243	88.0 (277.6)	109.0 (343.8)	72.9 (229.9)	1971	1963	33
Minneapolis	307	93.5 (295.0)	100.8 (317.9)	55.0 (173.6)	1975	1965	34
New York	14,315	83.8 (264.4)	92.8 (292.6)	120.8 (381.0)	1942	1949	29
Philadelphia	1,159	78.0 (246.1)	100.6 (317.4)	97.9 (308.8)	1963	1957	37
Washington D.C.	1,592	67.2 (211.8)	76.9 (242.6)	53.1 (167.5)	1975	1973	28

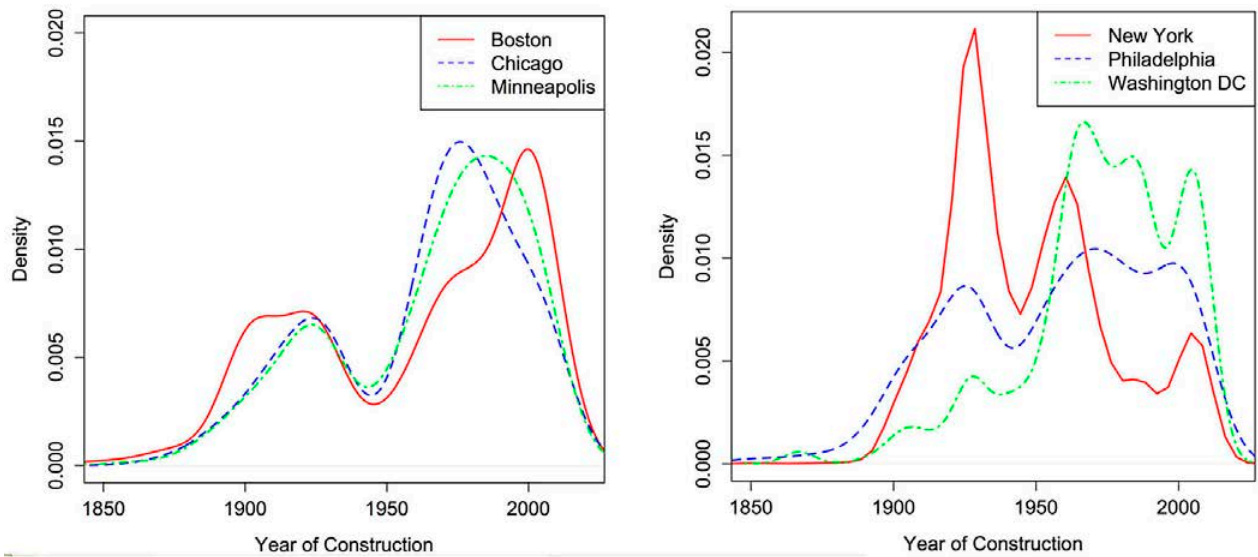

Figure 1. Density plots of year of construction by city.

Table 2. Pearson correlation coefficient for EUI and year of construction by city

City	All Buildings	By Building Type		
		Office	Multifamily	K-12 Schools
Boston	0.14	0.19	-0.01	0.32
Chicago	0.13	-0.20	-	0.29
Minneapolis	-0.07	-0.06	-	-0.09
New York	0.04	0.18	< -0.01	0.11
Philadelphia	0.11	-0.01	-0.14	-0.16
Washington D.C.	-0.08	-0.10	-0.26	-

Table 2 lists the Pearson correlation coefficient, r , for each of the six cities. Coefficients are given for all of the benchmarked buildings in each city, and are also divided by building type for each city. Correlation coefficients with an absolute value greater than 0.9 are typically considered strong, and between 0.7 and 0.9 are considered moderate. A positive correlation coefficient indicates a positive linear relationship between the two variables, i.e., EUI increases as year of construction increases, and a negative coefficient indicates a negative linear relationship.

Overall, the results show that the linear relationship between EUI and year of construction is weak across all of the six cities, and all of the building types. Most of the coefficients in the table have an absolute value less than 0.20. The largest coefficients are for K-12 schools in Boston and Chicago, which both have a positive correlation coefficient of around 0.30 (indicating an increase in EUI with newer buildings), but these correlations are still considered weak. There are both negative and positive correlation coefficients across all cities and building types, however, there are a few trends. The coefficients for multifamily residential buildings are all negative, suggesting that newer buildings have a lower EUI, although these coefficients are weak, and close to zero in some cases. In two of the cities – Washington DC, and Minneapolis – the correlation coefficients are all negative, again indicating that newer buildings in these cities have a lower EUI, but these coefficients are also all weak.

Table 3 provides the results for six simple linear regression models, one for each city (within each city all building types were used), with $\ln(\text{EUI})$ as the response variable and year of construction as the predictor variable. The estimated regression coefficients are given for each model, along with the standard errors, t-statistic, p-value, and an indicator of the level of significance for the test (* $p < 0.05$; ** $p < 0.01$; *** $p < 0.001$). The R^2 is also listed for each model, to indicate model goodness of fit. Model coefficients shown are based on units of kBtu/ft^2 ; the coefficient for the intercept would change for metric units, but the coefficient for year of construction and significance test would not.

The results show that there is a statistically significant linear relationship at $p < 0.05$ between year of construction and EUI in five of the cities – Boston, Minneapolis, New York, Philadelphia, and Washington DC. For Boston, New York,

and Philadelphia, the estimated regression coefficients for year of construction are positive, indicating an increase of 0.25 %, 0.10 %, and 0.30 %, respectively, in annual EUI for each one-year increase in year of construction. For Minneapolis and Washington DC, the estimated regression coefficients for year of construction are negative, suggesting a 0.34 % and 0.21 % decrease, respectively, in annual EUI for each one-year increase in year of construction. For all of the models, however, the R^2 is small, suggesting that year of construction is not a very good predictor of EUI, explaining less than 2 % of the variation in EUI in most cases.

Table 3. Simple linear regression results for $\ln(\text{EUI})$ and year of construction by city

City	Variable	Estimate	Std. Error	t-statistic	p-value	Sig.	R^2
Boston	Constant	-0.5925	1.1621	-0.510	0.610		0.015
	Year of Constant	0.0025	0.0006	4.221	<0.001	***	
Chicago	Constant	2.1129	1.8097	1.168	0.244		0.007
	Year of Constant	0.0012	0.0009	1.349	0.179		
Minneapolis	Constant	11.0122	2.5409	4.334	<0.001	***	0.022
	Year of Constant	-0.0034	0.0013	-2.599	0.010	**	
New York	Constant	2.3312	0.4366	5.339	<0.001	***	0.002
	Year of Constant	0.0010	0.0002	4.612	<0.001	***	
Philadelphia	Constant	-1.7704	1.6643	-1.064	0.288		0.011
	Year of Constant	0.0030	0.0009	3.586	<0.001	***	
Washington D.C.	Constant	8.2452	1.6291	5.061	<0.001	***	0.008
	Year of Constant	-0.0021	0.0008	-2.498	0.0127	*	

3.2 ENERGY PERFORMANCE OF LISTED HISTORIC BUILDINGS IN NEW YORK CITY

The results of the analysis examining the energy performance of listed historic buildings in New York City are presented in Tables 4 and 5.

The total number of buildings and distribution of building type for each group of designated historic buildings in New York is provided in Table 4. Approximately 12 % of the buildings (1,779) in the benchmarking data have some kind of historic designation. Since building type is a major determinant of EUI, it is important to understand whether the distribution of building types differs greatly between historic and non-historic buildings. The results show that the distribution of building types for designated historic buildings is similar to the distribution in the benchmarking data overall. However, designated historic buildings have a higher proportion of office type buildings compared to the overall benchmarking dataset, and buildings contributing within districts have a higher proportion of multifamily buildings compared to the overall benchmarking dataset. LPC listed landmarks have a much lower proportion of multifamily buildings compared to all the other groups.

Table 4. Building type proportion by designation status

Designation Status	N	Building Type					
		Office	Multifamily	K-12 Schools	University	Hotels	Other
All	14,315	0.09	0.62	0.01	< 0.01	0.01	0.27
All Historic	1,779	0.15	0.62	0.01	0.01	0.02	0.19
LPC Historic District	1,397	0.11	0.71	0.01	< 0.01	0.02	0.15
LPC Historic Landmark	335	0.31	0.26	0.01	0.02	0.06	0.34
NRHP Listed Building	90	0.21	0.60	0.02	0.01	–	0.16
NRHP Contributing in District	134	0.16	0.67	–	0.01	0.01	0.15

Table 5 provides summary statistics and results of the two-sample t-test comparing mean site EUI of historic and non-historic buildings. For each group, the total number of buildings (less those missing EUI data) is given, along with the median, mean, and standard deviation for EUI. The t-statistic and p-value for the test are listed, along with an indicator of the level of significance for the test. The results show that the mean and median site EUI is significantly lower for historic buildings (at $p < 0.001$) in all cases except individually landmarked buildings, both at the local level and at the federal level. For these two cases, the mean EUI of historic buildings is higher than for non-historic buildings, but there is no statistically significant difference between the two. One possible reason for these results could be differences in building type; Table 4 shows that individually landmarked buildings have a higher proportion of office buildings, and LPC landmarked buildings have a lower proportion of multifamily residential buildings.

Table 5. Summary statistics and results of two-sample t-test for site EUI by designation status

Designation Status	n	Site EUI, kBtu/ft ² (kWh/m ²)			t-stat	p-value	Sig.
		Median	Mean	Std. Dev.			
All	10,329	83.8 (264.4)	91.8 (289.5)	66.7 (210.3)	-	-	-
All Historic	1,369	78.2 (246.7)	82.3 (259.7)	38.7 (122.0)	-8.49	< 0.001	***
All Non-Historic	8,960	84.8 (267.5)	93.2 (294.0)	69.9 (220.4)			
LPC Historic District	1,125	76.8 (242.3)	80.0 (252.4)	36.9 (116.4)	-10.01	< 0.001	***
Non-LPC Historic Dist.	9,204	84.9 (267.8)	93.2 (294.0)	69.3 (218.6)			
LPC Historic Landmark	204	87.9 (277.3)	96.7 (305.0)	46.6 (147.1)	1.51	0.133	
Non-LPC Historic Land.	10,125	83.7 (264.1)	91.7 (289.2)	67.0 (211.4)			
NRHP Listed Building	70	82.6 (260.4)	92.8 (292.9)	43.5 (137.1)	0.21	0.837	
Non-NRHP Listed Building	10,259	83.8 (264.4)	91.8 (289.4)	66.8 (210.7)			
NRHP Contrib. in Dist.	107	74.1 (233.8)	79.4 (250.5)	31.5 (99.3)	-4.00	< 0.001	***
Non-NRHP Cont. in Dist.	10,222	83.9 (264.7)	91.9 (289.9)	66.9 (211.1)			

However, this difference in building type proportion is likely not responsible for the differences in EUI between these populations, as these buildings have similar mean EUIs in the benchmarking data as a whole – offices: 89.81 kBtu/ft² (283.33 kWh/m²); multifamily: 89.75 kBtu/ft² (283.14 kWh/m²).

4. DISCUSSION AND CONCLUSIONS

Comparing trends in year of construction and site EUI across six U.S. cities demonstrated that the median and mean values for these variables were generally similar across all cities. Examining the relationship between year of construction and site EUI showed that these two variables have only a weak linear relationship across all cities and building types. While year of construction is a statistically significant predictor in most cities, the R² values for all of the models are very low, indicating that year of construction is not a strong predictor of EUI. These conclusions with local data mirror previous work with nationally representative data in the U.S. showing year of construction to be a similarly weak predictor of EUI.

Address matching the benchmarking data for New York with auxiliary databases resulted in a new dataset containing metered energy performance for both historic and non-historic buildings. Statistical tests showed that designated historic buildings have significantly lower mean EUIs compared to non-historic buildings, although this trend does not hold for individually listed buildings, both at the local and federal level. The reason behind this trend is not clear, but initial analysis showed that differences in building type between historic and non-historic buildings do not appear to be the cause.

Overall, this study demonstrates the potential uses of municipal benchmarking data in understanding the older and historic building stock. This study represents a preliminary attempt to compare trends in building age and EUI across multiple U.S. cities using consistent statistical analysis. While simple regressions were used in this study, future work could consider multiple regression to control for other variables such as building type. This study also piloted a method for matching energy benchmarking data with auxiliary data about a building's listed historic status. While the present analysis of designated historic buildings was limited to New York because of the large quantity of publicly available data about its historic building stock, future work could explore the feasibility of expanding this method to other cities.

5. REFERENCES

- [1] K. Palmer and M. Walls. "Using information to close the energy efficiency gap: a review of benchmarking and disclosure ordinances," *Energy Effic.*, vol. 10, no. 3, pp. 673–691, Jun. 2017.
- [2] A. Webb. "Evaluating the energy performance of historic and traditionally constructed buildings," PhD Thesis, The Pennsylvania State University, 2017.
- [3] C. E. Kontokosta. "Local Law 84 Energy Benchmarking Data: Report to the New York City Mayor's Office of Long-Term Planning and Sustainability," 2012.

- [4] P. A. Mathew, L. N. Dunn, M. D. Sohn, A. Mercado, C. Custudio, and T. Walter. "Big-data for building energy performance: Lessons from assembling a very large national database of building energy use," *Appl. Energy*, vol. 140, pp. 85–93, Feb. 2015.
- [5] New York City Department of City Planning. PLUTO and MapPLUTO. [Online]. Available: <https://www1.nyc.gov/site/planning/data-maps/open-data/dwn-pluto-mappluto.page>
- [6] U.S. Department of the Interior, National Parks Service. National Register of Historic Places Program: Research. [Online]. Available: <https://www.nps.gov/nr/research/>
- [7] New York State Department of Parks, Recreation and Historic Preservation. New York State Cultural Resource Information System. [Online]. Available: <https://cris.parks.ny.gov/>
- [8] U.S. Energy Information Administration. 2012 CBECS Survey Data. [Online]. Available: <https://www.eia.gov/consumption/commercial/data/2012/>

Heritage values and thermal comfort in Neoclassical residential buildings of Athens, Greece

Tension or co-existence?

T. Koukou and K. Fouseki

Institute for Sustainable Heritage, Bartlett School of Environment, Energy and Resources, University College London (UCL), London, UK.

Abstract – This paper explores how meanings and values assigned by residents to historic buildings, drive or prohibit their energy efficiency interventions. More specifically, the paper examines the possible tension between the residents' need to improve the sense of thermal comfort while preserving the original features of their house. The focus of the study is located in the context of listed residential buildings in Athens, Greece. The selected buildings represent the so-called 'neo-classical' architectural style. Currently, the need of residents to improve the energy performance of the neo-classical built heritage leads to interventions that may jeopardize the heritage significance of the buildings, despite the rigid (if not too restrictive) legislative framework. Semi-structured interviews with residents recruited via 'snowballing' methods reveal that there is indeed a tension between the need to improve the thermal comfort during the winter period via the installation of mechanical means at the sacrifice of original features of the building. However, most residents are against the installation of air-conditioning systems on the façade of the building but very receptive to the adoption of photovoltaics and double-glazing windows. In conclusion, despite a few cases in which the façades were dramatically affected by double glazing and external shades, it was noted that the changes adopted by the residents were complying with the legislation in place and the architectural significance of the building.

Keywords – energy efficiency; thermal comfort; heritage values; neoclassical buildings

1. INTRODUCTION

Residents of traditional or historic buildings have been underutilized as a source of information concerning the building's performance. However, they should be considered as a guide regarding the indoor environment quality, since their behaviour can highlight whether its effect on comfort is positive or needs further attention [1]. There are many factors affecting inhabitants' behaviour towards thermal comfort with the most significant being the type of the dwelling, the orientation and the type of the room [2]. Drivers that can influence human reactions can be divided in the following categories: external, internal/individual and building properties where external include physical drivers (such as temperature, humidity, noise); internal include physiological (age, gender, etc), psychological (e.g. lifestyles, tendency for thermal comfort), awareness and social (interactions

with inhabitants)' and contextual drivers such as building properties, ownership status, etc [3]. While most research on thermal comfort has mainly focused on a set of optimum comfort conditions based on physiological models that can be universally applied, there is a growing acknowledgement that more research is needed on the perceived thermal comfort and the means people wish to employ their sense of comfort [4].

This paper offers an empirical study to the widely acknowledged tension between thermal comfort and heritage conservation in historic buildings. The paper focuses on the historic centre of Athens, Greece, where the majority of neoclassical, listed buildings are located. Currently, the remaining neoclassical stock lies deserted or restored with uncontrolled interventions, harmful to the integrity of their architectural form [5]. Thirteen in-depth, semi-structured interviews were conducted in summer 2016 and thematically analysed in order to explore residents' perceptions concerning values, thermal/acoustic comfort, renovation, energy efficiency, behaviours towards discomfort and the existing legislative framework. In this paper, focus will be placed on residents' behaviours towards energy efficiency interviews as they are dictated by heritage values and/or prioritization of thermal and acoustic comfort. The paper will argue that the ways in which residents value their houses relate to the ways in which the heritage elements of the structure evoke a sense of 'home' and 'comfort/cosiness'. At the same time, there are changes targeted to thermal comfort that can alter the character and integrity of the buildings, thus disturbing the balance between thermal comfort and heritage values.

2. METHODOLOGY

Thirteen semi-structured interviews were undertaken with residents of neoclassical buildings in Athens. This type of interview offers the flexibility of open-ended and non standardised interviews, in the sense that the interviewer can deviate from the question script and better communicate and interpret the objectives of the survey [6]. Free answer questions have the benefit of providing a variety of responses, acquiring elaborations, evaluating arguments and exploring descriptively the interviewees' point of view [7]. Participants were recruited through the snowballing method not only for logistic reasons but also for health and safety issues due to the fact that the interviews took place within the residences. Interviewing within the buildings was critical since this allowed the observation of physical changes over time, while the interviewees could pinpoint the aspects of their residences they valued the most. During the interview process, participants were shown pictures illustrating energy efficient alterations made to historic similar-type buildings in order to provoke reflections and discussions (photo elicitation method) [8]. At the end of each interview, after connection and trust was established, participants were asked to take photographs using the researcher's equipment, capturing some of their favorite characteristics of the house. Thus, participants were given the opportunity to dictate the aspects of their house they valued the most (photo production) [9]. The interview data were thematically coded via *detailed coding* (identifying keywords) and *axial coding* (classifying the

codes into general categories/themes). The following themes were extrapolated: expert/non-expert; reason for choosing residence; values; period of residence; perception of thermal comfort; changes concerning comfort improvements; attitudes towards energy efficiency; attitudes towards renovation; listing; future intentions.

3. FINDINGS

3.1 ATTITUDES TOWARDS ENERGY EFFICIENCY MEASURES

Overall, changes of the façades of the buildings under examination appear to have been respected since the decorative elements and the coat colour are intact and there is a lack of additional equipment at the façade (Figures 1a, 1b, 1c). Most of them are in a good condition, although in some cases further maintenance is required.

However, in three cases alterations driven by the need to improve both the acoustic and the thermal performance of the building—especially in the winter months—severely affected the appearance of the building. The implementation of aluminum double glazing, the addition of external shades and the change of the original coat colour, were some of the interventions altering the character of the corresponding neoclassical buildings (Figures 2a, 2b, 2c).

The photo elicitation process during which residents were shown images of neoclassical buildings with double-glazed windows, photovoltaics, plasterboards, air-conditioning and change of the coat colour on the façade provoked opposition to such alterations mainly justified by the impact of such interventions on the aesthetics of the buildings (Table 1).

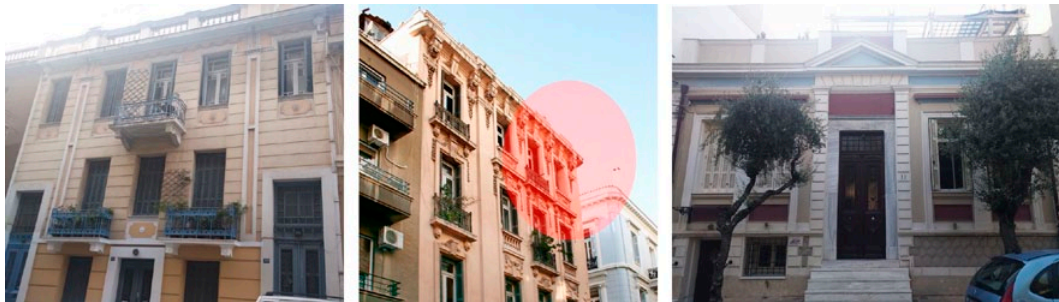

Figure 1a,1b, 1c. Façades without interventions, case studies. Photos: Koukou, T. 2016.



Figure 2a, 2b, 2c. Exterior changes. Photos: T. Koukou 2016.

Table 1. Summary of residents' attitudes towards energy efficiency

Attitudes towards energy-efficiency								
	Expert / Non-expert	Owner / Tenant	Double glazing	PV	Plasterboard (ceiling)	Plasterboard (interior)	A/C	Colour change (façade)
1	Non-expert	Owner	Difficult	–	●	●	●	●
2	Non-expert	Owner	v	●	●	●	●	●
3	Expert	Owner	●	●	●	●	●	●
4	Non-expert	Owner	v	●	●	v	●	●
5	Non-expert	Owner	●	●	●	●	●	●
6	Expert	Tenant	●	Difficult	●	●	●	●
7	Expert	Owner	v	●	v	v	●	v
8	Expert	Tenant	●	–	v	●	●	●
9	Non-expert	Owner	●	●	●	●	●	●
10	Expert	Owner	●	●	●	●	●	●
11	Non-expert	Owner	●	●	●	●	●	●
12	Non-expert	Tenant	●	●	●	●	●	●
13	Non-expert	Owner	●	●	●	●	●	●

v Already installed ● Yes ● Maybe ● No

One of the interventions that was unanimously disapproved by the respondents, was the potential installation of an air-conditioning device on the façade. Their contradiction was intensely expressed 'No, no never', 'Certainly not', 'It would ruin the façade' (male, 55–65, homeowner) and was attributed mostly to the listing of the façade, the restrictions it may pose, and aesthetic reasons.

Likewise, the use of plasterboard on the ceiling was perceived to result in the concealment of the ceiling decorative plasterwork and the alteration of the building's analogies (Figures 3a, 3b, 3c). A respondent stressed: 'These buildings have their own personality and if you change it they cannot function in the same way' (female, civil servant, 51–60, homeowner). On the other hand, two participants who had replaced the original ceiling plasterwork pointed out

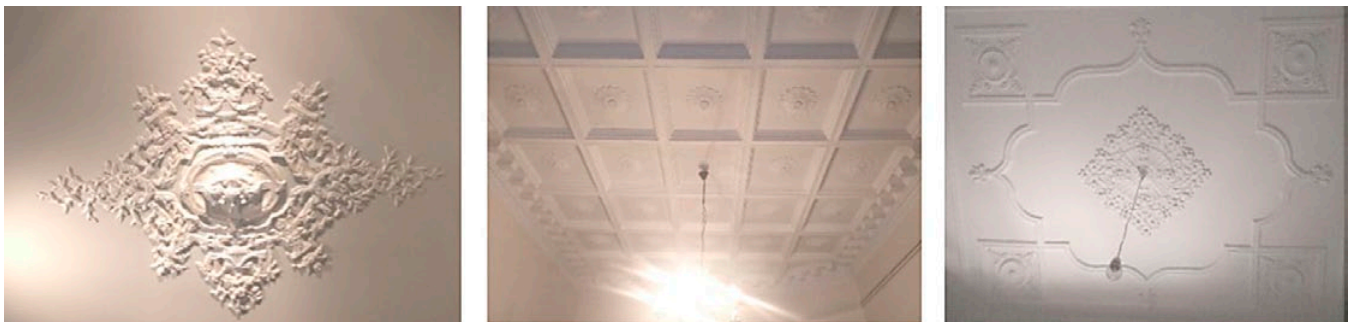

Figure 3a, 3b, 3c. Ceiling plasterwork, case studies. Photos: Koukou, T. 2016.

that 'the ceiling plasterwork was not considered to be of a significant architectural importance' and that the plasterboard reduced the floor-to-ceiling height, achieving a height closer to the human scale (male, director, 31–40, homeowner).

The application of new coat colour on the façade of the buildings caused diverse opinions. Seven of the interviewees maintained the original colours, even if they had to take a sample from the wall in order to recreate the original colours. Three of the participants commented on the strict legislative framework that dictates a restrictive range of acceptable colours. One individual had already altered the coat colouring while an additional four would do the same, 'with pleasure'. Another resident mentioned 'I would not like to apply a different coat colour, but a coating that can provide the appropriate insulation' (male, 61-70, homeowner)

The question about photovoltaics raised great skepticism among the interviewees. Most of them were negative due to aesthetic reasons ('photovoltaics are very ugly' (male, 61-71, homeowner)), lack of space, high cost, and/or unsuitable orientation in conjunction with the shading of the surrounding buildings. Despite the fact that one resident showed strong affiliation to photovoltaics, most of the respondents declared their lack of awareness in terms of how much energy savings they can make through the use of photovoltaics.

The most acceptable alteration that residents were willing to undertake was the replacement of the original windows with double glazed ones. Actually, three of the respondents had already replaced them. Some of the reasons provided by the respondents for this decision, were linked to the need to reduce heat loss and the perceived endurance of aluminum over timber. In a few cases, the alteration was imposed by the need to sound proof the interior. When participants were interrogated about their future plans of alterations, they prioritized the use of solar heating, the installation of ceiling fans and central heating and the replacement of the windows with double-glazed ones.

3.2 PERCEPTIONS OF THERMAL COMFORT

In Athens' climate, the neoclassical buildings function well during the hot summers but less so during the cold months. To avoid overheating indoors, internal blinds are often chosen, as external shading is not permitted in listed buildings. Generally, it becomes apparent that residents use heaters, or gas heaters and fan heaters, to improve the thermal comfort during the winter months. Only two respondents adopted more natural methods, such as using extra clothing, separating the rooms by closing certain doors, and in case of extreme moisture and cold, using a dehumidifier. In one case, the interviewee highlighted the positive effect of an internal atrium in terms of thermal comfort especially during winter, as the atrium facilitates circulation of hot air upwards, heating the upper levels of the building.

Additionally, it was noted that previous experiences can form one's behavior towards thermal discomfort, as residents of an elder generation, who adapted to the cold weather conditions in the past, were able to use passive ways for improving thermal comfort. On the other hand, residents growing up with certain

comfort expectations seemed to be leading a less natural and more luxurious way of life, as improving their thermal comfort in winter depended largely on the immediate use of mechanical means.

How varied and subjective the perceived thermal comfort can be, can be illustrated by the case of a non-listed, neoclassical building comprised of a stone masonry ground floor and a concrete first floor. Interestingly, despite the different construction materials (the thick stone wall tends to be cooler in the summer and winter months), the residents' views on thermal comfort did not differ. This case is a living example of how the properties of a building material cannot ensure comfort by themselves. Parameters such as the poor construction work, alongside the small amount of light penetration due to the surrounding environment, caused dampness and discomfort among the residents of the masonry ground floor, which is intensified by the lack of a heating system. Moreover, in this case the residents reported that 'the owner is unwilling to sell the building, as she loves it so much, that she could not bear its demolition and replacement by a block of flats' (female, dancing teacher, 31–40, tenant). This is an example showing that the designation of a building apart from potential restrictions, can have positive impact on sustaining the historic building stock and its values.

3.3 WHAT DRIVES OR PROHIBITS CERTAIN ENERGY EFFICIENCY STRATEGIES IN HISTORIC RESIDENCES

Generally, the ownership status is believed to strengthen interventions for the energy efficiency and the improvement of thermal conditions indoors [10]. In this case, the ownership or tenancy status does not seem to be an important factor, as energy-efficient measures have been taken by both owners and tenants. Moreover, the placement of plasterboard on the ceiling, and the change of coat colour on the façade, has only been employed by experts, while the plasterboard internally and the double-glazing has been used by both experts and non-experts. Moreover, other energy efficient means were mentioned, such as the addition of external thermal insulation and acoustic insulation in the internal walls (expert, owner) and acoustic insulation in the slabs (non-expert, owner).

The current financial state, with restricted motives in conjunction with the lack of the residents' awareness concerning environmental, economic and energy-efficient benefits, can act as impediment to the further implementation of certain strategies [11]. This was proved by the interviews as the high maintenance cost and lack of funding were deemed to be major obstacles, along with legislation regulation, its long delays and bureaucratic issues. The effort and time that one needs to spend, and the difficulty of finding suitable materials and craftsmen, were some of the obstacles mentioned. The phrases 'I can't', 'It is not permitted', 'I don't have the right', 'it was imposed by the legislation', 'it is restrictive', 'the cost is huge', 'I feel wronged by the state', were mentioned more than once, highlighting even more the restrictions set. Specifically, in the case of renovation, all of the residents remarked the high cost. This appears to be an extremely negative parameter, as this was the reason for one resident who revealed to have partially regretted choosing to live in a neoclassical building.

Following the aforementioned obstacles, the sense of freedom for any desired changes showed to be very limited for most interviewees, especially due to the facts that ‘the façade of the residence is listed’ or that ‘the entire building has been designated a listed national monument’. Less than half of the residents replied that they feel free, supporting that ‘the restrictions are right and, in some cases, even useful’ (male, editor, 61–70, homeowner).

Lastly, one resident showed reluctance for making any changes, while another one expressed a feeling of inability and lack of interest in doing so. This difference between *can* and *want* is an important element that should be scrutinized, as in some cases they may coincide or be completely opposite. The latter resident’s comment (‘I cannot do whatever I want. I could not do anything, but I didn’t want to do anything’ (female, civil servant, 51–60, homeowner), pinpoints the fact that in this case legislation, which for many is seen as an obstacle, did not affect her actions. On the contrary, another resident mentioned that ‘the colour of the façade was imposed by the legislation, I wanted to paint it in the colour salmon, but I couldn’t’ (female, architect, 71–80, homeowner), which illustrates the way restrictions set certain rules that must be obeyed by the residents.

However, there were cases showing diversions from what the legislation permits. The comparison between the past and present condition of one of the case studies, showcases the result of adhering to the legislation, respecting the heritage integrity of the listed building, or breaching the regulations and radically changing the original condition, with the installation of A/C and alteration of the façade. (Figures 4a and 4b).

These incidents show that there are cases where owners do not abide by the legislative framework and that there is absence of a controlling authority concerning lawlessness. This was also observed by some residents who noted that ‘I think whatever you do, there is a way of no one ever bothering you. I don’t think that there are many reasons for someone to get anxious with that in Greece’ (male, director, 41–50, homeowner,) and ‘as people act, we will break the law as well, even if all these buildings were exactly as they were’ (female, civil servant, 51–60, homeowner).



Figure 4a, 4b. Past and present condition of a case study. Photos: Koukou, T. 2016.

4. CONCLUSION

In this paper, we showed in the context of neoclassical buildings in Athens, that works undertaken in the case studies mostly involved painting, internal changes for functionality reasons and conservation of the façade characteristics. The aesthetics of the 'façade' were highly appreciated, but functional values related to thermal and acoustic comfort were of higher priority for most residents. The residents were reluctant to install air-conditioning on the façade or plasterboards on the ceiling. Photovoltaics provoked less opposing views, while the change of coat colour and double-glazing received positive comments. Despite the varying nature of the residents' thermal comfort perceptions, their behaviour towards discomfort presented many similarities. The higher tolerance of heat was highlighted by the adaptation of the residents themselves, while the modification of the environment included light means. On the contrary, cold was mostly faced directly with the use of mechanical heating systems. Lastly, the obstacles of legislation, bureaucracy and cost appeared to be the most dominant, affecting the residents' sense of freedom. In addition, despite the existence of a restrictive legislative framework, it became apparent that state control on what works are being undertaken, is limited.

Through this research and the analysis of the findings, certain arguments can be retrieved that can be implemented in historic buildings in general. Although the perceived thermal comfort is satisfactory, there are ways to successfully integrate strategies for a higher energy-efficiency and lower energy consumption. Potential energy losses from the windows must be evaluated and be taken into account early in the process of renovation, to achieve improved comfort through better configuration of use. Moreover, public awareness needs to be fostered, as both experts and non-experts can play a pivotal role. Owners or tenants need to be informed about the legislative restrictions prior to their start of residence. Legislative frameworks that present abstraction and lack of subsidies inhibit the historic buildings' protection and, for this reason, revisiting and revising the laws could prove to be more successful. Financial incentives are fundamental, and apart from the state, other institutions, such as museums, or non-governmental organisations, could provide funds and support the maintenance of listed buildings. Additionally, it should be highlighted that the implementation of law should not only rely on citizens, but also on controlling bodies.

Steps for further research include better understanding of the dynamics of the relationship between the indoor environment and the residents' behaviour, as its integration early in the design process is critical. Lastly, a comparison of the afore-analyzed residents' behaviours with those of other geographical areas sharing a similar historic building stock, could provide fruitful feedback and inform policies beyond the national boundaries.

5. REFERENCES

- [1] L. Zagreus, C. Huizenga, E. Arens and D. Lehrer (2004), "Listening to the occupants: a Web-based indoor environmental quality survey", *Indoor Air*, 14(8), pp. 65–74.

- [2] V. Fabi, R.V. Andersen, S. Corgnati and B.W. Olesen (2012). "Occupants' window opening behaviour: A literature review of factors influencing occupant behaviour and models", *Building and Environment*, 58, pp. 188–198.
- [3] Fabi, V. et al. 2012. 'Occupants' window opening behaviour: A literature review of factors influencing occupant behaviour and models', *Building and Environment*, Vol. 58, pp. 188–198.
- [4] Fabi, V. et al. 2012. 'Occupants' window opening behaviour: A literature review of factors influencing occupant behaviour and models', *Building and Environment*, Vol. 58, pp. 188–198.
- [5] M. Biris. *Athinaiki Arhitektoniki 1875–1925* [Athenian Architecture 1875–1925]. Athens: Melissa. 2003.
- [6] B. Gordon and G.B. Willis. *Cognitive Interviewing: A tool for improving questionnaire design*. SAGE Publications, Inc. 2005.
- [7] S.L. Payne. *The art of asking questions*. Princeton, N.J: Princeton University Press. 1980.
- [8] M. Banks (2008). *Using Visual Data in Qualitative Research* [Online]. United Kingdom: Sage Publications Ltd. Available at: <http://methods.sagepub.com.libproxy.ucl.ac.uk/book/using-visual-data-in-qualitative-research> [July, 20, 2016].
- [9] S. Pink (2007). *Doing Visual Ethnography*, [Online] SAGE Publications, Ltd. Available at: <http://methods.sagepub.com.libproxy.ucl.ac.uk/book/doing-visual-ethnography> [July, 20, 2016].
- [10] M. Duncan. (2003) *Engineering Concepts on Ice*. [Online] Available at: www.iceengg.edu/staff.html [20 July, 2016].
- [11] S. Petrova, M. Gentile, I.H. Mäkinen and S. Bouzarovski (2013). "Perceptions of thermal comfort and housing quality: exploring the microgeographies of energy poverty in Stakhanov, Ukraine", *Environment and Planning*. 45(5), pp. 1240–1257.
- [12] I. Theodoridou, A.M. Papadopoulos and M. Hegger (2012). "A feasibility evaluation tool for sustainable cities – A case study for Greece", *Energy Policy*, 44, pp. 207–216.

Energy efficiency intervention and preservation in residential built heritage

Analysis, proposal and results in the Gros district of San Sebastian

E.J. Uranga, L. Etxepare, I. Lizundia and M. Sagarna

Dept. of Architecture, University of the Basque Country, (UPV/EHU), Donostia/San Sebastian, Basque Country. Email: enekojokin.uranga@ehu.eus; lauren.etxepare@ehu.eus; inigo.lizundia@ehu.eus; maialen.sagarna@ehu.eus

Abstract – By the second decade of the 20th century we were already aware of the importance of achieving greater energy efficiency in the existing building stock. To that end it is fundamental to carry out a massive energy intervention on the residential building stock. But to be able to undertake this massive intervention one of the dilemmas that most concerns the different European Governments as well as the academic and research world should previously be solved. The dilemma is what happens when we try to undertake this energy intervention on residential built heritage. This paper deals with the proposal for energy intervention on the residential built heritage of the Gros district, in the city of San Sebastian. The objective of this research is to obtain energy improvement in buildings of this urban area and help to elucidate how much historic European cities could improve energy efficiency without losing their heritage values.

Keywords – energy efficiency; residential; built heritage; intervention; preservation

1. INTRODUCTION

There is currently a dilemma, within the building sector, that has not yet been resolved: how to improve the energy efficiency of buildings in historic European city centres without losing their heritage values. This generates a dichotomy that is difficult to solve. On the one hand, since the commitment assumed in the Kyoto Protocol [1], the EU has set up an energy saving policy in regard to the building sector. To this end, the EU underlines the importance of an energy intervention in the existing building stock in order to achieve greater energy efficiency. This has been transposed in several European Directives, such as Directive 2002/91/EC [2], Directive 2010/31/EU [3], or Directive 2012/27/EU [4]. On the other hand, there is increasing awareness concerning existing buildings as a part of the built heritage. This concern is expressed both by the different public administrations and by the citizenship. This means that, at present, more and more buildings are being protected by some kind of urban planning [5]. Some urban planning programmes such as the PEPPUC of San Sebastian [6] are being revised to include more historic buildings with the aim of protecting them.

Nevertheless, this dichotomy between the need for energy intervention and the conservation of the existing building stock has not yet been resolved by current

legislation. Recent surveys indicate that this is not an easy problem to solve [7]. The research presented in this paper aims to dilute the problem of this dichotomy and it is based on the PhD thesis “The Energy Intervention in Residential Built heritage. Analysis of Gros District in Donostia/San Sebastian” [8] defended in the year 2017 at the Department of Architecture of the UPV/EHU.

2. THEORY OF ENERGY INTERVENTION IN BUILT HERITAGE: TEIBH

The need and appropriateness of energy interventions in existing buildings is beyond doubt. But there is also a need to protect most of the historic buildings, among other reasons due to the increasing need for interventions regarding energy efficiency. Facing this dichotomy a “Theory of Energy Intervention in Built Heritage”, or TEIBH, is proposed. This theory aims to break the incompatibility between the need for energy efficiency improvement of existing building stock and the conservation of the heritage values of these buildings. For this purpose, the TEIBH proposes a series of intervention degrees. The TEIBH gives a scale of values in which the energy intervention and the conservation of the heritage is extended or reduced depending on the original value and energy performance of the building. For this purpose a 5 degree scale is developed.

The first degree, or Grade 0, is not an intervention per se. It consists of a preliminary analysis of the current state of the buildings, both from the point of view of their heritage value, as well as their energy performance result. With these heritage and energy values we can begin to assess which intervention degree we should establish for each building.

Grade I or “Conservation/Restoration/Reconstruction”, relates to the most monumental buildings. In this case, the heritage value is so important that it must prevail over the energy achievement. The scale is ascending, thus some monumental buildings will not have any type of energy intervention, while other less monumental buildings could improve some aspects of their efficiency.

Grade II or “Selective Intervention” refers to buildings that, despite not having a high degree of official protection, have an important heritage value. This heritage value can be an urban, architectonic or constructive value. In Grade II, although the heritage value prevails, the energy intervention must be carried out.

In Grade III or “Massive Intervention”, the energy objective begins to predominate over the conservation values of the buildings. A “massive” intervention is undertaken on the envelope of the existing building. This means that the configuration of the original building starts to be modified in order to achieve a good energy result.

Finally, in Grade IV or “Invasive Intervention”, what absolutely prevails is energy efficiency over the original building shape and its original heritage values. These buildings are considered not to have any heritage value. Therefore, the aim of the intervention must be to achieve the highest energy performance of the existing building. Through this “massive” intervention, it should be achieved a passive house building or a nearly zero-energy building (NZEB), insofar as the original building allows it.

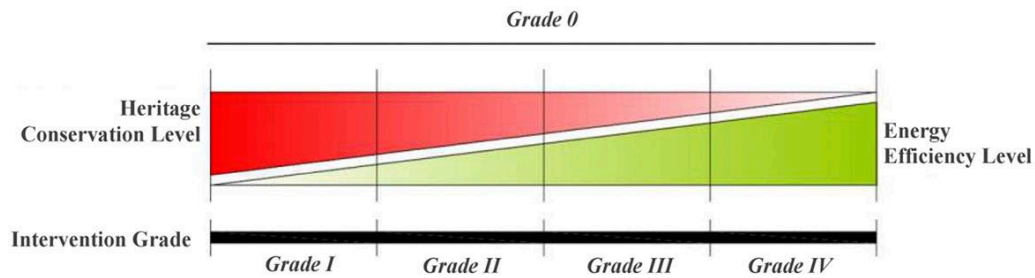

Figure 1. Theory of Energy Intervention in Built Heritage or TEIBH.

3. ANALYSIS: THE APPLICATION OF THE “TEIBH” ON THE GROS DISTRICT

3.1 PRACTICAL APPLICATION OF THE TEIBH

For the proposal of TEIBH not to be just a simple theoretical solution, a practical application of the theory for a specific case has been made in the Gros District in the city of San Sebastian. For this purpose, and before starting to assess the impact that an energy intervention by way of applying the TEIBH in this area would have, an in-depth analysis of the main characteristics of the district has been conducted. The analysis is related to a heritage point of view of the buildings as well as to an energy efficiency performance point of view.

3.2 FIVE ARCHITECTONIC/CONSTRUCTIVE STYLES

One of the consequences of this analysis has been the classification of the entire Gros residential building stock into five Architectonic / Constructive Styles. Architectonic, because of the time and style when the buildings were built. Constructive, because of the configuration of the structural elements and the envelope that forms them. This analysis has only been carried out on buildings of residential use, as these are the most numerous in the building sector. The intervention carried out in them will be what will decide if the energy efficiency objectives dictated by the EU will be achieved or not.

The first style obtained is the Nineteenth-century Style. This style is characteristic of the 19th century San Sebastian city centre style, developed in the Ensanche Cortazar expansion district. In the case of Gros, there is the peculiarity that in most cases the buildings have structures made of concrete. These buildings date from the first two decades of the 20th century and represent 44 percent of the total buildings in the area. The second style obtained is the Rationalist Style representative of the architectonic revolution that took place during the third decade of the 20th century around the Modern Movement. That revolution occurred both in the architectonic style and constructive typology. This style represents 21 percent of the buildings and was developed during the 1930s and 40s. The third is the Postwar Style, characterized by the post civil war period and followed by the period of autarchy in Spain during the 1940s and 50s. This style is represented in 19 percent of the Gros district buildings. The fourth and fifth styles are based on the Development Period that occurred in Spain during the 1960s and 70s. This period is characterized by the strong economic growth that occurred all



Figure 2. Five Architectonic/Constructive Styles in the Gros District.



Figure 3. Distribution of the five Architectonic/Constructive Styles in the Gros District.

around Europe and, in the case of Spain, especially for the construction sector. It has been divided into two because there are great differences between their constructive solutions. The First Development Style covers 8 percent of the total buildings of Gros, as does the style of the Second Development.

3.3 HERITAGE AND ENERGY ANALYSIS OF THE FIVE STYLES

After determining the five styles, the next step was to analyze the styles from a heritage and energy point of view. First, the characteristics of the existing residential built heritage of the Gros district were analyzed. For that purpose, the current law that protects this residential built heritage was applied: the Special Plan for the Protection of Urban Built Heritage of San Sebastian (PEPPUC). This document covers the Spanish and Basque laws on built heritage protection, and also reflects the protection established by the Council of San Sebastian as part of its municipal urban planning. PEPPUC proposes several grades of protection for the different heritage buildings. These grades range from Grade A, referring to monumental buildings, to Grade D, referring to buildings with just an urban environment value. The higher grade of protection, the fewer interventions of the

protected buildings can be allowed. Based on this classification, it was analyzed how these grades are distributed in the Gros district. In terms of energy, two surveys were carried out. First, a more superficial urban survey, and secondly a more exhaustive analysis of the energy performance of the five Architectonic / Constructive Styles. The analysis of the five styles includes the volume and shape of each style, the materials used for the envelope elements, and the energy values of these materials.

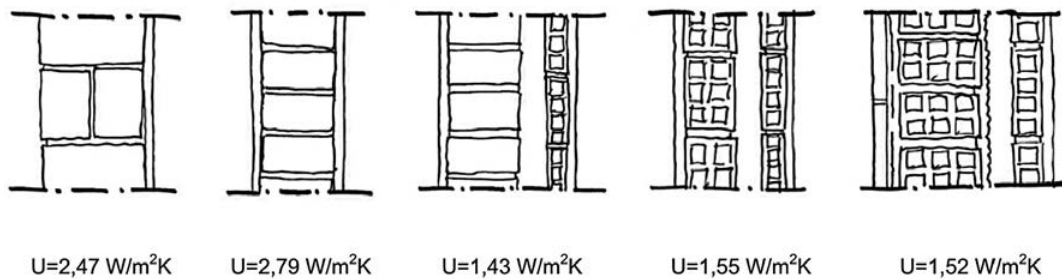

Figure 4. Façade solution and transmittance of the five Architectonic/Constructive Styles.

With this analysis, and with the values obtained, we were able to define what Grade 0 established by the TEIBH would be. As a result, it was possible to consider what the most appropriate energy intervention for each building should be, as well as its heritage conservation degree. Thus, we could foresee a balanced intervention obtaining an improvement in the energy efficiency of the building without losing its heritage values.

4. PROPOSAL: FIVE INTERVENTION GRADES

After conducting the scope analysis of the district the TEIBH was applied in the Gros district. Now, the five Intervention Grades should be taken into account and applied to the five Architectonic / Constructive Styles. For this purpose, and from a heritage point of view, the PEPPUC classification of the different grades was introduced into the five Intervention Grades of the TEIBH. Thus, PEPPUC's Grades A and B are covered by TEIBH's Grade I, Grades C and D are covered by Grade II, and Grade D is covered by Grade III. For Grade IV it is considered that there are no heritage values for those buildings to be protected, so no PEPPUC grade is applied.

Something similar was done for the energy values that must be achieved for each grade of the TEIBH. This scale of grades has been distributed through seven levels of energy intervention. Each of these levels means an energy improvement in the elements that compose the entire envelope of the building. These levels were distributed in the following way: Level 0 or E0 is the level that refers to the current state of the building; Level 1 or E1 means the replacement of the joinery; Level 2 or E2 refers to the thermal insulation of the interior courtyards of each plot; Level 3 or E3 refers to the thermal insulation of the roof; Level 4 or E4 refers to the thermal insulation of the rear façade; Level 5 or E5 refers to the thermal insulation of the main façade; and finally, Level 6 or E_{lim} is the reference

concerning what the energy performance value of the building would be if it were a new building instead of an existing one. In this way, it is progressively determined, in each level, how each element of the building complies with the Spanish regulation on energy saving, the DB-HE “Energy Saving” [9]. In this law, the maximum heat transmittance for each element of the envelope of the building is established. These energy levels were introduced into the grades of the TEIBH. Thus, for TEIBH Grade I the energy level introduced is E0. This level is a zero-value due to the importance of the heritage values of Grade I buildings. For Grade II, Levels E1, E2 and E3 were introduced. And for Grade IV the maximum level or E6 were introduced, since it is considered that this intervention would be equivalent to a NZEB.

In this way, what is established by the TEIBH for each Intervention Grade is applied. That is, achieving progressive energy efficiency improvement as the energy intervention is applied, in the same way as the heritage value of the buildings decreases. This is what has been done for the Gros district case.

Table 1. TEIBH application in Heritage and Energy Intervention Levels.

TEIBH	PEPPUC	Energy Intervention Level	Type of Intervention
<i>Grade 0</i>	All	–	–
<i>Grade I</i>	Grade A Grade B	Level 0 – E0	No intervention
<i>Grade II</i>	Grade C Grade D	Level 1 – E1 Level 2 – E2 Level 3 – E3	Joinery replacement Interior courtyards insulation Roof insulation
<i>Grade III</i>	Grade D	Level 4 – E4 Level 5 – E5	Rear façade insulation Main façade insulation
<i>Grade IV</i>	None	Level 6 – E _{Lim}	NZEB

5. EVALUATION AND RESULTS: 5 CASES SELECTED

5.1 SELECTION OF FIVE CASES

With all these data, a calculation study was conducted to find out what energy improvement results can be achieved for each level in real cases. For this purpose, five models of real buildings were selected. This selection was made through a comparative process based on the most common urban building typology in the area. On the one hand, the closed block is the most abundant building type in the Gros district accounting for 53 percent of the buildings. On the other hand, the plot with two exterior façades and two dividing walls is the most numerous with another 53 percent. For this reason, this urban typology was chosen as the most representative model. After a preliminary selection of 25 buildings, five each style, five of them were chosen as an existing representative model of the rest of the area, one for each Architectonic / Constructive Style.

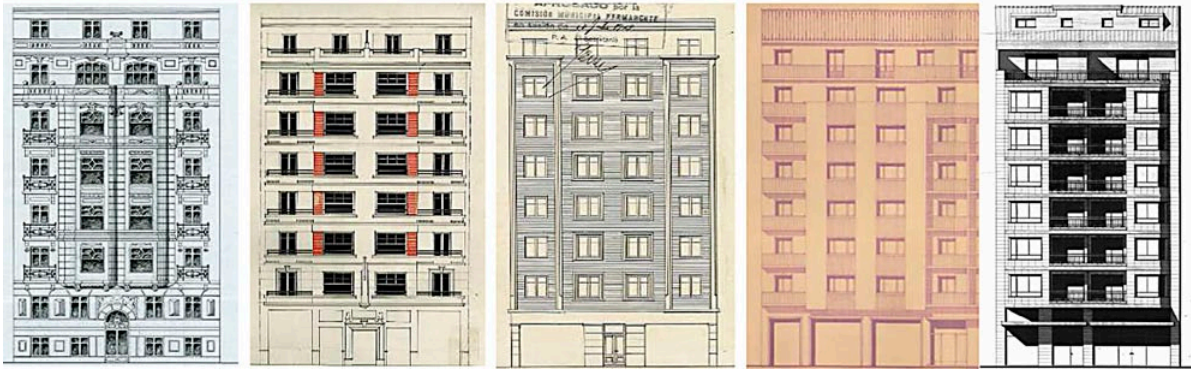

Figure 5. Five cases selected for the application of the TEIBH.

5.2 EVALUATION

Once the five models were chosen, Grade 0 of each building was analyzed. In other words, the reality of each model was considered in terms of heritage protection and energy performance. We analyzed how each building is considered by the PEPPUC for heritage protection. It was observed that, in most cases, buildings are poorly protected. Regarding energy performance, energy consumption was estimated for each building, giving an energy classification as established in Spanish R.D. 235/2013 on Energy Efficiency [10]. Hence, energy efficiency level E0 was obtained. After obtaining the initial data, each of the following Intervention Grades of the TEIBH was introduced, according to the pre-established energy levels. First, the replacement of the joinery or Level 1 (E1) was carried out. After that, the interior courtyards of the plot were insulated as established in Level 2 (E2). Third, the roof was insulated, Level 3 (E3). Fourth, the rear façade was insulated as in Level 4 (E4). Finally, the main façade was insulated, Level 5 (E5). A final calculation was made for Level 6 (E_{Lim}), to determine what energy performance results these buildings would have if they had been built today with the insulation values determined by the current Spanish energy efficiency regulations. Both Level E0, energy performance of the current building, and Level E_{Lim} , a new building taking into account new legislation demands, allow us to compare values with each of the proposed interventions or levels.

5.3 RESULTS

A gradual improvement in energy efficiency is observed in all energy intervention levels carried out in the different style models. In this regard, it can be said that the results vary considerably in terms of the percentage of energy improvement obtained according to each intervention level. Thus, the intervention level that visibly improves energy performance of the buildings in all the style models is the Level E1 or the replacement of joinery, amounting to around 30 percent in most cases. With intervention Level E2 or insulation of the interior courtyards improved energy efficiency of between 20 and 30 percent is achieved, depending on the model. Intervention Level E3 or roof insulation, improves energy efficiency of the buildings less, around 10 to 15 %. And with the last two intervention levels,

Level E4 or insulation of the rear façade, and Level E5 or insulation of the main façade, each intervention improves the building energy efficiency by around 10 to 15 percent for each case. These results indicate that, without having an impact on the most valuable elements of the buildings, from a heritage point of view, Levels E4 and E5 or the envelope façades, 65 to 75 percent of energy efficiency improvement can be obtained in buildings. Now, if we compare the energy performance of each style model at every intervention level we can see that for Level 0 (E0) the Nineteenth-century Style, Postwar Style and Second Development Style, have a better energy performance than the Rationalist Style or First Development Style. For the following energy interventions carried out, (Levels E1, E2, E3 and E4), the Nineteenth-century Style is the one that obtains greatest achievements along with the Rationalist Style. The other three styles obtain a less pronounced energy improvement. Finally, and after concluding all the interventions, in Level 5 or E5, we observe that the model, which obtains better results, is the Nineteenth-century Style, whereas, the First Development Style is the model that obtains the worst energy performance results after all the intervention levels.

Table 2. Different intervention levels results for each style model conclusions

Total consumption of non-renewable energy – kWh/m ² year					
Intervention	19 th Century Style Model	Rationalist Style Model	Post-war Style Model	1 st Development Style Model	2 nd Development Style Model
Level 0 – E0	162.37	201.22	167.64	193.02	154.75
Level 1 – E1	134.22	180.40	142.48	175.69	134.13
Level 2 – E2	99.86	145.13	126.09	153.64	118.73
Level 3 – E3	99.29	134.05	113.42	135.65	106.26
Level 4 – E4	77.71	116.66	102.48	126.05	98.18
Level 5 – E5	60.35	96.45	92.72	115.35	89.12
Level 6 – E _{Lim}	61.41	61.73	61.79	61.72	61.74

On the one hand, based on this survey and for the case of the Gros district, it could be concluded that a detailed study of each building would be necessary before the energy intervention. Applying the TEIBH, we have seen that a progressive energy intervention can be made. This energy intervention must be adapted to each building of the different styles according to its own energy need and heritage value. However, in summary, and based on the analysis performed, it can be said that the intervention in every style is carried out to Level E3, achieving an energy improvement of 60-75 percent. This means that these energy interventions do not have an impact on the heritage values of the buildings, as they do not touch the main protected elements of the envelope, the façades. On the other hand, it can be said that for any type of building or area where a heritage value and a need for energy intervention are foreseen, a preliminary analysis should be made. As we have seen in the case of Gros District, a preliminary analysis can help to determine the best way to start an energy intervention, considering the conservation of the built heritage values. We must not forget that we are in a process in which most of the buildings face interven-

tions regarding energy efficiency in a relatively short period of time. A previous survey would help us foresee the possible results before starting it blindly. Finally, the question is whether we must lose part of the built heritage values in order to obtain an energy improvement that in any case will never be optimal since it is carried out on existing buildings. We must not forget that the dual objective is not only to achieve a more efficient historic city from an energy point of view, but also one that is recognizable from a built heritage point of view.

6. REFERENCES (EXAMPLES)

- [1] Council of European Union. OJ L 130 de 15/05/2002. 2002/358/EC: Council Decision of 25 April 2002 concerning the approval, on behalf of the European Community, of the Kyoto Protocol to the United Nations Framework Convention on Climate Change and the joint fulfilment of commitments thereunder. Available: <http://eur-lex.europa.eu/legal-content/EN/TXT/PDF/?uri=CELEX:32002D0358&from=EN>
- [2] Council of European Union. OJ L1, of 4.1.2003. Directive 2002/91/CE of the European Parliament and of the Council, 16 December 2002, on the energy performance of buildings. Brussels: CE; 2002. Available: www.eur-lex.europa.eu/legal-content/EN/TXT/PDF/?uri=CELEX:32002L0091&from=EN.pdf
- [3] Council of European Union. O J L153/13 of 18.6.2010. Directive 2010/31/EU of the European Parliament and of the Council, 19 May 2010, on the energy performance of buildings (recast). Brussels: EU; 2010. Available: www.eur-lex.europa.eu/LexUriServ/LexUriServ.do?uri=OJ:L:2010:153:0013:0035:EN.Pdf
- [4] Council of European Union. O J L315/1 of 14.11.2012. Directive 2012/27/EU of the European Parliament and of the Council, 25 October 2012, on energy efficiency, amending Directives 2009/125/CE and 2010/30/EU, and repealing Directives 2004/8/CE and 2006/32/CE (Text with EEA relevance). Strasbourg: EU; 2012. Available: www.eur-lex.europa.eu/legal-content/EN/TXT/PDF/?uri=CELEX:32012L0027&from=EN.pdf
- [5] E.J. Uranga and L. Etxepare. "Parque edificado o patrimonio edificado: La protección frente a la intervención energética. El caso del barrio de Gros de San Sebastian", presented at the "Congreso Internacional Eficiencia Energética y Edificación Histórica–EEEH 2014–", Fundación de Casas Históricas y Singulares, Fundación Ars Civilis, Madrid, 2014. Available: <http://www.energy-heritage.com/>
- [6] Council of San Sebastian. BOG no. 70, 11 April 2014, p. 9 to 60. Special Protection Plan of Constructed Urban Heritage of San Sebastian – PEP-PUC-. San Sebastian: ASS; 2014. Available: www.ssl4.gipuzkoa.net/castell/bog/2014/04/11/bo140411.pdf#Page=1
- [7] E.J. Uranga, L. Etxepare, I. Lizundia and M. Sagarna. "The impact of the energy efficiency regulation on residential built heritage – The case of Gros district in the city of San Sebastian – 2010/2015", Presented at the 2nd International Conference on Energy Efficiency and Comfort of Historic Buildings. EECHB 2016, Belgium Building Research Institute (BBRI), Brussels, 2016. Available: <http://www.eechb.eu/>

- [8] E.J. Uranga. “La Intervención Energética en el Patrimonio edificado Residencial. Análisis del barrio de Gros en Donostia/San Sebastian”, [Doctoral Thesis], University of the Basque Country–UPV/EHU, Donostia, 2017.
- [9] Ministry of Public Works. BOE no. 219, 12 September 2013, p. 67137 to 67209. Order FOM/1635/2013, 10 September, updated Basic Document DB-HE “Energy Saving”, of the Technical Building Code, approved by Royal Decree 314/2006, 17 March. Madrid: MF; 2013. Available: www.codigotecnico.org/web/recursos/documentos/
- [10] Ministry of Presidency. BOE no. 89, 13 April 2013, p. 27548 to 27562. Royal Decree 235/2013, 13 April 2013, which approves the basic procedure for the energy efficiency certification on buildings. Madrid: MP; 2013. Available: www.boe.es/boe/dias/2013/04/13/pdfs/BOE-A-2013-3904.pdf

Building stock analysis as a method to assess the heritage value and the energy performance of an Alpine historical urban settlement

E. Lucchi¹, D. Exner¹ and V. D'Alonzo^{1,2}

¹ Institute of Renewable Energy, EURAC Research, Bolzano/Bozen, Italy.

Email: elena.lucchi@eurac.edu; dagmar.exner@eurac.edu; valentina.dalonzo@eurac.edu

² Department of Civil, Environmental and Mechanical Engineering, University of Trento, Italy.

Email: valentina.dalonzo@unitn.it

Abstract – Energy retrofit strategies at the urban scale play a strategic role in promoting the regeneration of existing towns and revitalizing the local building real estate market. The paper presents an operative tool for the building stock analysis of the historical settlement of Calavino. The town is located in the alpine area of Italy (Province of Trento), characterized by high natural and heritage values. The urban grid is typical of a historical alpine historical center: it consists of 220 traditional buildings, mainly built with local stone and occasionally mixed with wood and masonry. The presence of similar dimensional, typological, morphological and constructive features, allowed the development of an integrated approach to understand the energy consumption and the heritage values, moving the attention from the single building to the urban level. The research method was structured in the following phases: (i) building stock analysis, departing from data collection, on-site investigations, infrared technology surveys; (ii) definition of the “reference building typologies” according to architectural features, construction periods, thermal properties and conservation levels, in order to estimate the energy-demand modelling and the baseline scenario; and (iii) integration of the collected data into a Geographic Information System (GIS) software to graphically visualize on the cartography also the potential for the energy renovation of the historical town. This method represents a structured and manageable approach for the data collection, which exploits the information from different sources. The implementation of the “enhanced with GIS” typology approach, in a second step, will support public authorities during the decision-making process to choose among priorities and to define policies and incentives for the historical buildings renovation, as well as to set precise energy targets within a specific time frame in the sustainable urban plan.

Keywords – historic center, building stock analysis; traditional buildings; vernacular buildings; Alpine area; energy performance evaluation; Geographic Information System (GIS)

1. INTRODUCTION

In recent years, the EU fostered several policies to reduce the final energy use (20 %) and greenhouse gas (CO₂) emissions (20 % compared to 1990 levels), and to increase the share of renewable energy (20 % of overall energy

consumption) until 2020 [1; 2; 3; 4]. The European Directives 31/2010/CE [5] and 2012/27/EU [2] showed the big potential for achieving energy savings and CO₂ emissions reduction through the refurbishment of existing buildings, besides the construction of new low-energy buildings [2]. Italy has fully complied with these policies [6; 7], setting more ambitious targets. The “National Energy Strategy” (SEN) and the “Action Plan for the Energy Efficiency” (PAEE) [6] identified the building sector as a key element for reaching these objectives. The energy saving expected from the refurbishment of the existing building stock in 2020 is 48.9 TWh/yr for the residential buildings and around 17.2 TWh/yr for non-residential buildings [6].

Several Italian studies deal with this topic, presenting different methodologies to analyse the energy potential of the building stock as the starting point to identify the most energy-consuming typologies, to define effective renovation strategies and to calculate the impact of the retrofit measures [8; 9; 10; 11]. Two main approaches were underlined: (i) “top-down” approach based on the determination of the energy performance of each building, looking for the relationship between statistical information and energy consumptions [8; 9]; and (ii) “bottom-up” approach that defines the overall performance of the stock, starting from the energy assessment of few “reference buildings” (a building assumed as representative of each typology in terms of building features and thermal properties) [10; 11]. Normally, the “reference buildings” are defined departing from geometry [11; 12; 13; 14], age classes [11; 12; 13; 14; 15], U-values, climate data [16], indoor temperature or use of appliances [13]. The choice of these parameters varied with the scopes of the evaluation and the features of the building. The strengths of the “top-down” models are related to the availability of aggregate data, the simplicity, and the reliance on existing energy data for the residential sector. At the same time, the reliance of the “top-down” models on historical data is also a drawback, since they have less capability to model discontinuity in technology. Furthermore, the lack of detail regarding the final energy consumption reduces the capability of identifying key areas where improvements in energy consumption are needed [17]. The high level of detail is instead a strength of “bottom-up” models and gives them the ability to model also technological changes. The “bottom-up” models have the capability of determining the energy consumption of each end-use to identify areas for improvement. Compared with the “top-down” approach, they need detailed input data, complex calculation and simulation techniques. In this study, a “bottom-up” approach is used.

2. AIMS OF THE WORK

The work presents an operative tool for the building stock analysis applied to the historical settlement of Calavino, a little town located in the alpine area of Italy (Province of Trento). The study is preliminary to adopt the “typology approach” defined within the International Energy Europe (IEE) projects *Tabula (Typology approach for building stock energy assessment)* [12] and *Episcope (Energy performance indicator tracking schemes for the continuous optimization of refurbishment processes in European housing stocks)* [13], in order to estimate

the overall energy demand of the constructions at the urban level. The implementation of this approach in a historical town requires however a general overview of the main energy-consuming typologies, by at the same time also identifying protection levels, building functions, age classes, traditional features, conservation states and utilisation levels of the building stock. Traditionally, this methodology [12; 13] focused only on residential buildings, which are characterized by homogeneous features in terms of thermal zones, indoor air temperature, internal loads and occupancy time. Consequently, the variables considered were only: (i) “building age classes” that reflects the changes of the construction methods and energy savings policies over time and affects the construction features of the envelope and HVAC systems; and (ii) “building size class” that determines the geometry of the buildings to determine heat losses through the thermal envelope and the surface-to-volume ratio (S/V) (relation between surface of the thermal envelope and heated volume) that is strongly connected to the specific-energy demand. Only one age class for historical constructions was identified, which considers building built before 1945 without any difference (e.g. pre-industrial or industrial buildings). In case of the historical settlement of Calavino, the traditional approach has been adapted to the cultural and heritage values of an historical city centre, identifying the most prevailing “building typologies”. That means building categories with similar characteristics related to energy and heritage aspects. Moreover, the scale of this work is smaller than [12; 13], which allows a deeper analysis of the building stock. In addition, the municipality highlighted that people in the past moved out from the centre to live in single-family houses with gardens, which led to a progressive abandonment of the historical town. Therefore, this building stock analysis is a tool for improving the knowledge and for understanding the potentials of the historical town. The results of this study constitute an effective support for policy- and decision-makers to define tailored urban plans and development policies. In fact, quantifying and locating the thermal energy demand of the buildings is essential to foster sustainable management and planning initiatives across the historical settlement and for the whole town. In addition, the urban renewal and the energy retrofit of buildings can be a “stimulus” also for the “social revitalization” of the historical centre.

3. MATERIALS AND METHODS

3.1 RESEARCH METHOD

The work is structured in the following phases: (i) data collection on the building stock, and their classification in specific datasheets; (ii) spatial-based analysis of the data; and (iii) identification of the “building typologies” using a mathematic approach.

3.2 DATA COLLECTION ON THE HISTORICAL BUILDING STOCK

A preliminary data collection is crucial for the “typology approach” which includes the four principal steps: (i) the determination of the “building typologies”, in order to define the “reference buildings”, (ii) the energy-demand modelling and baseline scenario, (iii) the development of renovation packages for the identified reference

buildings and (iiii) the determination energy saving potential. The data collection is based on the following steps: (i) historical analysis; (ii) on-site surveys; (iii) photographic campaigns; (iv) infrared thermography (IRT) surveys; (v) collection and analysis of geometric data on historic buildings; (vi) collection and analysis of the Energy Performance Contracting (EPC) documents.

Particularly, the historic analysis has been conducted on historical maps for traditional buildings (i.e. maps from the *Catasto Fondiario Austriaco*), records of the Cultural Heritage Authority, and books for listed buildings. The study permitted to detect the historic values, the construction periods, and the heritage-related legislation at building and urban level. In parallel, the on-site visits allowed to document the use of buildings, the architectural and constructive characteristics of the buildings (façades, roofs, ceilings, windows, doors, balconies), the conservation state, the level of utilization and the presence of gardens or other areas. In addition, a vast majority of buildings was photographed to give a general overview of the building stock and to collect and store specific information on the construction method and conservation state. Thanks to a Global Positioning System (GPS), the images were georeferenced and integrated into the map through a Geographical Information System (GIS) software, to catalogue and analyse the buildings according to their dimensions and architectural features.

Energy aspects were defined using different kinds of analyses and surveys. First, an IRT survey was done to identify the presence of energy or conservation issues on the building envelope. It was realized using a thermal imaging camera Flir T630sc and according to ISO 6781 [18] and EN 13187 [19] standards. It investigated the structure of the construction, the material used and the presence of thermal bridges, decay, moisture, and water percolation. Secondly, the features and the thermal properties of the building envelope (i.e. wall construction type, baseplate/basement ceiling, roof/top floor ceiling and windows) were deduced from catalogues of typical national or regional construction materials [12; 20], national standards [21], historical building regulations [22] as well as on-site visit and IRT surveys.

Furthermore, the EPC documents were gathered from the Energy Agency of the Province of Trento. Building characteristics from EPC include heated surface and volume, S/V ratio, construction year, number of number of floors, attachment to other buildings (detached, semi-detached or attached), thermal performance of the building envelope, type and fuel of the heating, ventilation and air-conditioning (HVAC) systems. Finally, measured energy consumption values were given by the municipality about non-domestic electricity use, SH and DHW in public buildings. Starting from these investigations, the following data were analyzed for each building: (i) building location; (ii) construction period; (iii) heritage-related legislation; (iv) typological aspects (e.g. building use and type, presence of traditional features, constructive elements for walls, roofs, basements, windows, etc.); (v) conservation state (e.g. damage and level of utilization); (vi) energy aspects (e.g. geometry, covered or built-up area, features and thermal properties of the building envelope, main characteristics of energy generation, distribution and regulation systems, both for heating and cooling systems; presence and type of







013	UNITA' EDILIZIA C-013 Piano Generale degli Inasediamenti storici Schedatura e analisi Realizzato per: Susanna Serafini Data: 11/01/2017	Comunità di Valle Via J. piazza C.D. 05 Rappresenta: Comune di Malcesine	Comune amministrativo Comune catastale N. di particella edificabile	Indirizzo Calavino 35	013		
Vincoli storico artistico-architettonici Categoria Intervento Piano vigente Fronte		Inizio catastale R1 fine intervento 01/01/2017	fine catastale R2 fine intervento 01/01/2017	presenza di cemento armato non invecchiato R3 [X] in ferro armato R4 R5	Proprietà pubblica [X]	pubblica []	credito pubblico []
Cartografia				Documentazione fotografica			
Estratto planimetria storica 1890 				Co. 			
Estratto catastale 				Ex 			
Estratto Piano Regolatore 				Dato 			
Coordinate Lat: 45°50'00.261 N Long: 10°51'08.272 E				The interior 			

Figure 1. An example of the datasheet conducted for each historic building. Source: S. Serafini, M-S. Marini.

renewable energy sources). Particularly, we noted that the assigned values of the technical building systems (e. g. boiler efficiency) varied considering the year of construction and the building typology. Each building is described by a specific datasheet, for a total of 220 datasheets (Figure 1).

3.3 SPATIAL ANALYSIS OF THE DATA

All the described and collected information about the studied buildings were linked to each individual building using a GIS software. The spatial analysis of the data helped the estimation and the extraction of the geometric data of the buildings, since this information was unavailable for each single construction. To obtain the morphological features two digital models are used, both derived from airborne Light Detection and Ranging (LiDAR) data, which were gathered from the GeoBrowser of the Province of Trento. The two models are the Digital Surface Model (DSM), which represents the highest feature elevations, and the Digital Terrain Model (DTM), which represents the ground surface of the study area. Subtracting the DTM from the DSM, heights of the above-ground features

are obtained [24] and a map with the morphological features of the buildings (e.g. covered surface, minimum, maximum and mean height) is performed. It is worth underlining that all the data processing was done using open-source software (i.e. Rstudio, GRASS GIS and QGIS). From the information inserted in the datasheets (Figure 1), a table was generated (1 building/1 row) by developing a macro in Excel and it was merged with the shapefile inside the GIS software. The resulting database was subjected to a process of statistical analysis. Thus, several maps can be created with different data and combinations of them. In section 4 the most relevant maps are presented.

3.4 IDENTIFICATION OF THE “BUILDING TYPOLOGIES”

The aim of this first step is to divide the entire building stock into the most prevailing “building typologies” and thus to assort buildings with similar characteristics related to energy and heritage aspects to the respective building typology. The result of this first phase, is the definition of the “reference buildings”, representative of each typology in terms of building features and thermal properties, in order to model the baseline scenario of the energy-demand of the building stock as well as to develop renovation packages tailored to the identified reference buildings. As mentioned before, in case of Calavino we applied the “typology approach” [11; 12; 13] to the historic centre, which is characterized by buildings with different uses, heritage values and architectural peculiarities. In this case, referring to historic constructions, the four variables adopted to the matrix, of which the building typologies are generated, were (see also scheme in Figure 2):

Table 1. The four base parameters for the generation of building typologies

I Building function/use	a. mainly residential use; b. “special use” such as school, theatre, church; c. auxiliary buildings such as garage, garden shed; d. “other” buildings such as buildings with agricultural use	... affects thermal zone, indoor air temperatures, internal loads and occupancy time
II Building owner	a. public; b. private; c. body governed by public law	... affects energy retrofit funding, communication strategies
III Building age class	a. < 1860; b. 1860-1939; c. > 1939	... represents a construction period, reflecting geometric, constructive and technical features
IV Building shape	a. detached; b. agglomerate; c. linear	... describes the geometry of the buildings, (S/V)

According to these parameters and extracting the relevant data from the datasheets, every building was assigned to one of the resulting 20 “building typologies”. Every building typology was additionally subdivided into the four different classes of heritage value (a. listed; b. protected as historic ensembles; c. not subject to conservation-related regulation; d. not listed with an historical element).

As there is only a little part of buildings with “special use” (see also section 4), we did not apply the fourth parameter to this typology. The few “auxiliary” and “other” buildings will be excluded from the energy analysis as they are not heated.

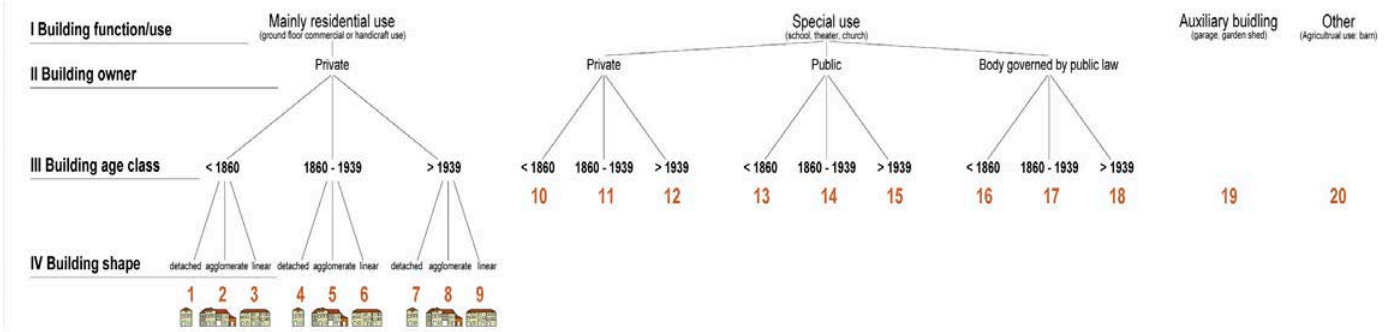

Figure 2. Tree diagram from typology matrix for Calavino (© EURAC).

4. RESULTS

The building stock of the historic centre is composed of 220 buildings, which corresponds to a total covered area of around 22,840 m². The buildings were constructed in three “building age classes” [12]: (i) < 1860; (ii) between 1860 and 1939 and (iii) > 1939. A large majority was built in the first age class, and only a few in the other classes. Another topic regards the heritage values. The majority of the buildings are not subject to any conservation-related regulation or not listed but have a historical element. Only few buildings are listed or protected as historic ensembles. In the past, each building belonged mainly to one owner. On the one hand, this situation caused a lack of investment in the renovation of buildings (especially in the internal parts) but, on the other hand, it favored the excellent conservation of green areas and kitchen gardens. The building stock is composed mainly by private buildings, but there are also public and private buildings with a public use. The composition of the building stock is synthetized in Table 2.

Table 2. Composition of the building stock

Building age classes (%)			
Ante 1860	1860-1939	Post 1939	-
84.2	3.8	12.0	-
Heritage values of buildings (%)			
Listed	Protected as historic ensembles	Not subject to conservation-related regulation	Not listed with an historical element
5.7	1.9	75.1	17.2
Building owner (%)			
Private	Public	Private with a public use	-
90.9	4.8	4.3	-
Building shapes (%)			
Detached	Agglomerate	Linear	-
15.8	42.1	41.6	-

A large part of the entire building stock is used for residential purposes (79.4 %), while 8.6 % of the buildings have a “special” use (like e.g. a school, a theater, a music house, a social center or a parish complex), 11.5 % are negligible auxiliary (e.g. garages, green houses, but also an aqueduct) and 0.5 % rural buildings. Public buildings have a special use (90.0 %) or are negligible auxiliary buildings (10.0 %). Private buildings with a public use are special (77.8 %), auxiliary (11.1 %) and residential (11.1 %) buildings. Private buildings have mainly a residential function (86.8 %). Finally, residential buildings are classified in three different “building shapes” [11] as follows: “detached”, “agglomerate” and “linear”. Other private buildings have auxiliary (11.6 %; e.g. garages or greenhouses), special (1.1 %; e.g. a private chapel), and rural (0.5 %; e.g. a rural house) functions.

The following map, gives an overview of the utilization level of the buildings (Figure 3).

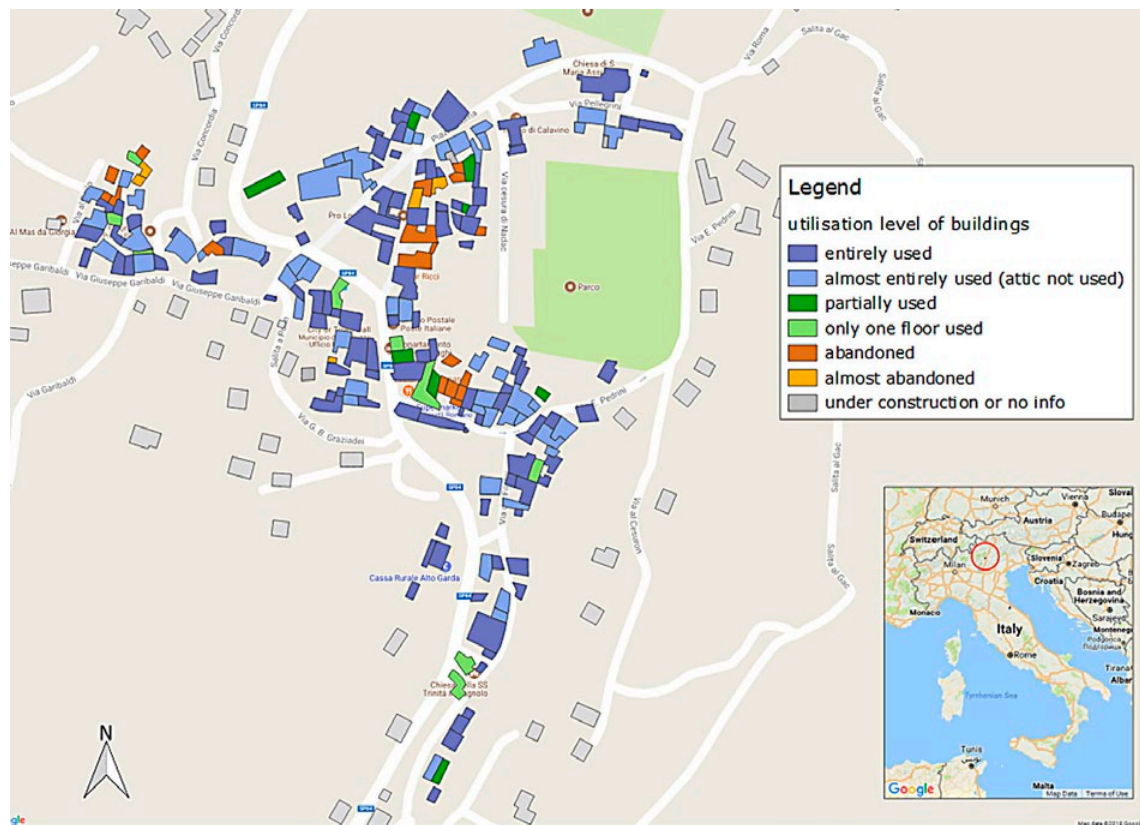

Figure 3. Utilisation level of the historical building stock of Calavino. Source of data: Municipality of Madruzzo and Google Streets; own elaboration.

It is significant, that relatively many buildings are abandoned (9.1 %) or almost abandoned (2.4 %). Only about half of the buildings are used entirely (51.7 %), while in 26.3 % the attic floor is not used and in 9.1 % one or more floors are not used. Figure 3 shows the reference building typologies (according to Figure 2).

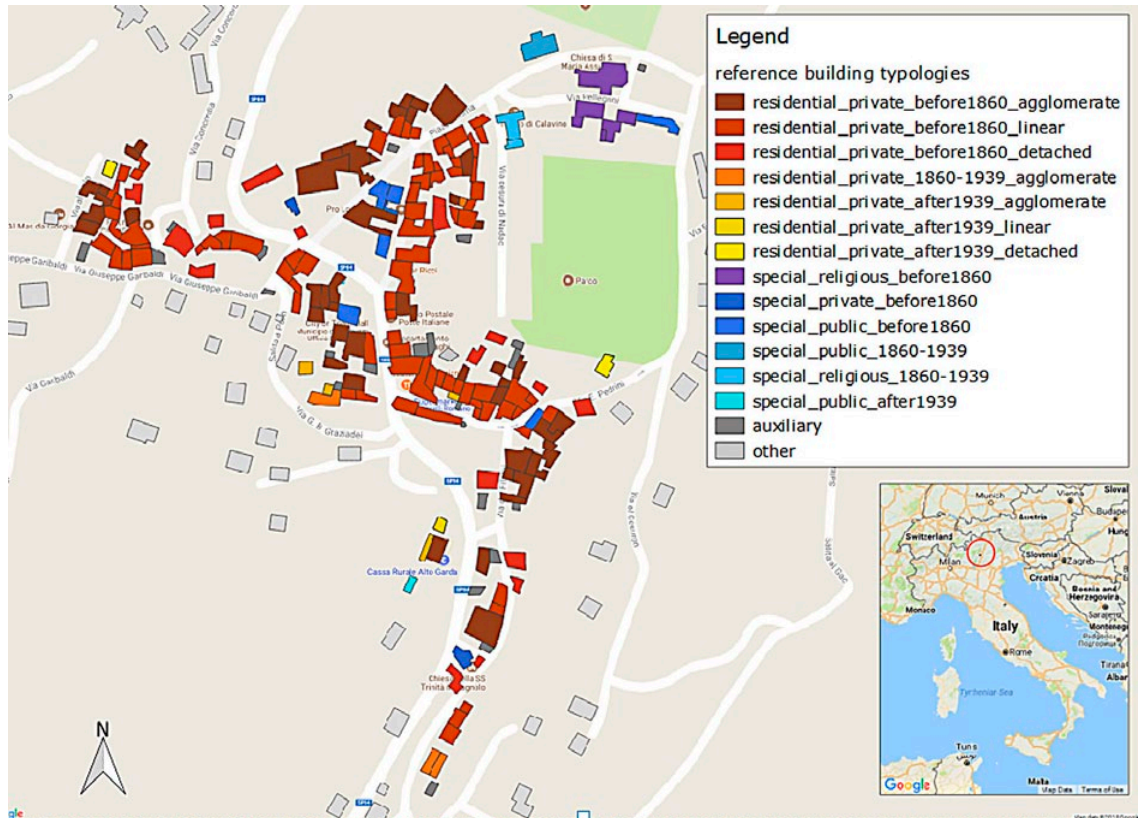

Figure 4. Reference building typologies (according to energy aspects). Source of data: Municipality of Madruzzo and Google Streets; own elaboration.

5. DISCUSSION AND CONCLUSIONS

In the past, the building stock analysis concentrated on the built context on a larger scale, not differentiating between historic and existing buildings. When it comes to energy saving potential, there are many differences between these two types of building typologies: (i) in case of historic buildings or in heritage buildings, it is necessary to adopt tailored energy retrofit solutions (not standard solutions as in existing buildings), starting from detailed knowledge of historical constraints, heritage values and building materials; and (ii) the knowledge of the conservation state and the level of utilisation of the buildings also allows the identification of the best opportunities for the energy retrofit. In this case, the definition of “building typologies is an intermediate step for the building stock analysis of historical towns, allowing the identification of protection levels, building functions, age classes, traditional features, conservation states and utilisation levels of the building stock. As a matter of fact, the adopted methodology permitted a detailed definition of the “building typologies” according to energy aspects, in order to analyse in a second step the energy consumption of the building stock and to propose more ad hoc retrofit measures tailored to every building typology. Particularly, the measures to retrofit and make livable the high presence of abandoned or partially abandoned buildings, will allow to use and revitalize the already existing structures instead of needing new constructions.

Detailed knowledge of the historical building stock is very important because it is possible to define for each building typology (i) a more accurate energy-demand modelling and determination of baseline scenario; (ii) tailored energy retrofit solutions considering the heritage values, the conservation state and the level of utilisation of the buildings; (iii) specific energy policies that consider the heritage values, both at the building level and in relation to the other urban areas; and (iv) targeted funding that meet the real needs of users and building heritage. Since the new urban plan is going to be developed by the municipality, this study can also represent the basis for a participatory planning process and for a socio-logical analysis on the historical town that will go with the drafting of the urban plan. At this stage, a social survey will help us to define better these measures, supporting also the definition of strategies for the reduction of the energy demand (for instance through the analysis of consumer behaviour). Moreover, a broader approach towards the local energy transition can start from these results to integrate the energy renovation of the existing buildings in the urban and regional planning process.

6. ACKNOWLEDGMENTS

A special thanks to the Mayor of the Municipality of Madruzzo, Michele Bortoli, and the architects Susanna Serafini e Maria Stella Marini for the on-site analysis and the realization of the datasheets of Calavino, a historical town in the Municipality of Madruzzo.

7. REFERENCES

- [1] European Commission, COM 772 final, Communication from the Commission, Energy efficiency: delivering the 20 % target (2008), European Commission, Bruxelles, 2008.
- [2] European Parliament, Directive 2012/27/EU of The European Parliament and of the Council of 25 October 2012 on energy efficiency, amending Directives 2009/125/EC and 2010/30/EU and repealing Directives 2004/8/EC and 2006/32/EC, Official Journal of the European Union, 14 November, 2012.
- [3] European Commission, COM, 885 final, Energy Roadmap 2050 (2011).
- [4] European Union, Decision No. 406/2009/EC of the European Parliament and of the Council of 23 April 2009 on the effort of Member States to reduce their greenhouse gas emissions to meet the Community's greenhouse gas emission reduction commitments up to 2020, Official Journal of the European Union.
- [5] European Parliament, Directive 2010/31/EU of The European Parliament and of the Council of 19 May 2010 on the energy performance of buildings (recast), Official Journal of the European Union.
- [6] Ministero dello Sviluppo Economico (MISE), Strategia Energetica Nazionale: per un'energia più competitiva e sostenibile, MISE, Roma, 2013.
- [7] Ministero dello Sviluppo Economico (MISE), Piano d'azione italiano per l'efficienza energetica, MISE, Roma, 2014.
- [8] Bentzen J. & Engsted T., A revival of the autoregressive distributed lag model in estimating energy demand relationships, *Energy* 26 (2001) pp. 45–55.

- [9] Mangold M., Österbring M., Wallbaum H., Handling data uncertainties when using Swedish energy performance certificate data to describe energy usage in the building stock. *Energy and Buildings* 102 (2015) pp. 328–336.
- [10] Filogamo L., Peri G., Rizzo G. & Giaccone A., On the classification of large residential buildings stocks by sample typologies for energy planning purposes, *Applied Energy* 135 (2014) pp. 825–835.
- [11] Exner D., DALonzo V., Paoletti G., Pascual R., Perneti R., Building Stock Analysis for the Definition of an Energy Renovation Scenario on the Urban Scale, in: *Smart and Sustainable Planning for Cities and Regions. Results of SSPCR 2015*, Springer, 2017, pp. 33–54.
- [12] Ballarini I., Corgnati S. P., Corrado V, Use of reference buildings to assess the energy saving potentials of the residential building stock: The experience of TABULA project, *Energy Policy* 68 (2014) pp. 273–284.
- [13] IEE Project Episcopo, <http://episcopo.eu> (accessed 16 January 2018).
- [14] IEE Project RePublic_ZEB, <http://www.republiczeb.org> (accessed 16 January 2018).
- [15] Aelenei, L. et al. New Challenge of the Public Buildings: nZEB Findings from IEE RePublic_ZEB Project, *Energy Procedia* 78 (2015) 2016–2021.
- [16] Šijanec Zavrl M., Stegnar G., Rakušček A., Gjerkeš H., A Bottom-Up Building Stock Model for Tracking Regional Energy Targets. A Case Study of Kočevje, *Sustainability* 8(10) (2016), 1063.
- [17] Swan L.G., Ugursal V.I., Modeling of end-use energy consumption in the residential sector: A review of modelling techniques, *Renewable and Sustainable Energy Reviews* 13 (2009) pp. 1819–1835.
- [18] ISO (International Organization for Standardization), Thermal insulation. Qualitative detection of thermal irregularities in building envelopes. Infrared method, Standard ISO 6781, ISO, Genève, 1983 (rev. 2012).
- [19] UNI (Ente Italiano di Normazione), Thermal performance of buildings. Qualitative detection of thermal irregularities in building envelopes. Infrared method, Standard UNI EN 13187, UNI, Milano, 1998.
- [20] Benedetti C., Erlacher P., Girasoli M. T., Paradisi I., Pasetti Monizza G., Ratajczak J. et al., *AlpHouse. Quaderno per il recupero energetico. Raccolta di casi studio per interventi sul patrimonio edilizio tradizionale*, Regione Autonoma Valle d'Aosta, Aosta, 2013.
- [21] UNI (Ente Italiano di Normazione), Prestazioni energetiche degli edifici, Parte 1: Determinazione del fabbisogno di energia termica dell'edificio per la climatizzazione estiva ed invernale, Standard UNI/TS 11300-1 (2014), UNI, Milano, 2014.
- [22] Dellanna S., Lona D., Calavino P.R.G. *Insedimenti storici*, Comune di Calavino, Calavino, 2005.
- [23] UNI (Ente Italiano di Normazione), Prestazioni energetiche degli edifici, Parte 2: Determinazione del fabbisogno di energia primaria e dei rendimenti per la climatizzazione invernale, per la produzione di acqua calda sanitaria, per la ventilazione e per l'illuminazione in edifici non residenziali, Standard UNI/TS 11300–2 (2014), UNI, Milano, 2014.
- [24] Tooke T.R., Laan M.V.D., Coops N.C., Mapping demand for residential building thermal energy services using airborne LiDAR, *Applied Energy* 127 (2014) pp. 125–134.

Improving the energy efficiency of built heritage in cold regions

Issues and opportunities

A. Luciani, K.L. Nilsson, S. Lidelöw, S. Bhattacharjee and T. Örn

Department of Civil, Environmental and Natural Resources Engineering, Luleå University of Technology (LTU), Luleå, Sweden. Email: andrea.luciani@ltu.se

Abstract – The paper presents results from the research project “Smart energieffektivisering av kulturhistoriska byggnader i kallt klimat”. The research is expected to develop, test and assess methods and solutions to increase the energy efficiency of heritage timber buildings in the northernmost part of Sweden.

The sub-arctic climate, with long, cold winters and mild summers, requires a significant use of energy, especially in historic buildings. This means that the difference in thermal performance and energy use with newly built buildings is greater and, at the same time, that even non-invasive interventions can be enough to save a considerable amount of energy with a limited impact on heritage values.

Valuable timber buildings from the late 19th and early 20th century are analysed in the cities of Piteå, Malmberget and Kiruna. Results are based on data collected on their energy and thermal performances, on the analysis of their constructional features and on the assessment of their heritage value.

Keywords – built heritage; energy efficiency; timber buildings; cultural values; cold climate

1. INTRODUCTION

The research project “Smart energieffektivisering av kulturhistoriska byggnader i kallt klimat” (“Smart energy-efficiency solutions for heritage buildings in cold climates”) aims to investigate how heritage valuable buildings in cold climate regions can be made more energy efficient in a smart way, without affecting their heritage and architectural values. Buildings located in cold regions are using more energy for heating, meaning that more savings are possible. Unfortunately, there are many examples from the past of irresponsible energy saving efforts applied to heritage buildings, such as the application of extra insulation and the change of valuable historic windows with new ones. The project is part of the Swedish Energy Agency’s research and development programme Spara och Bevara (Save and Preserve).

In this project, energy measurements and simulations, as well as heritage values, are under investigation in typical timber buildings built between the 19th and early 20th century in Northern Sweden. Different retrofit measures and strategies will be developed and simulated in the studied houses. The goal is to develop and disseminate scientifically based and practically applicable methods and techniques

for improving the energy efficiency of heritage valuable timber houses in cold climates.

Besides describing the methods adopted to collect qualitative information and quantitative data on case studies, this paper aims at presenting some preliminary results of the project. Controversial issues that have emerged so far will be discussed, especially in relation to heritage values. For this reason, the discussion mainly focuses on interventions to increase the energy performance of the building envelope, which are among the most impactful on the cultural values of heritage buildings but, at the same time, have a high potential for energy saving in cold climates.

2. DESCRIPTION OF THE ANALYSED BUILDINGS

The case studies selected for this study are timber buildings with a recognised cultural value built between the late 19th and early 20th century in the northernmost part of Sweden (Kiruna and Gällivare municipalities are above the Arctic Circle). They all lie within a subarctic climate zone according to Koppen classification, with long, cold winters and mild summers.

The Rådhus in Piteå, in the northern Bothnian coast, is today used as a public museum for the City of Piteå. It was built between 1829 och 1837 as a court-house, but today it houses exhibit halls, offices and a small shop and reception.



Figure 1. Analysed buildings. Clockwise: the Rådhus in Piteå, Bläckhorn B53 in Kiruna, house 158 in Malmberget and house 420 already moved to Koskullskulle. Photos: Tomas Örn and Andrea Luciani.

It is situated in the main square of the City of Piteå. It has a recognised heritage significance and since 1994 it is a listed building. [1] The building is also part of an area of national importance from a cultural point of view. [2] The central heritage significance is the architecture and design of the building as well as its function as a character building for the adjacent square and the overall cityscape.

The “Bläckhorn” houses are located in Kiruna, founded in 1900 as the company town of Luossavaara-Kirunavaara AB (LKAB) in order to mine the rich iron ore deposits in the area. The houses, designed by the architect Gustaf Wickman as multifamily residential units for LKAB workers, embody many of the typical construction features of the “Kiruna style”. [3] The project has studied the houses identified as B52 and B53, which were among the first timber variants to be built (1901-04). They were also among the first ones to be moved to their new location in the summer 2017, after the 2004 announcement of the need to move a significant part of the town to continue mining. The B52 and B53 houses are part of a designated area of national interest [4] and they are protected in the local development plan due to their heritage significance.

As in Kiruna, the case studies analysed in Gällivare municipality are residential buildings owned by the company LKAB and affected by the impacts of mining activities. Part of a cultural environment of national importance [2], they are among the 30 heritage buildings that will be preserved by moving them from the company area of Malmberget to the nearby locality of Koskullskulle. House 420 (former address Långa Raden 7, Johannes neighbourhood) was built in 1911 in Jugend style for LKAB managers and has already been moved in autumn 2016. House 158 (current address Puoitakvägen 5, Hermellin neighbourhood) was built in 1897 for the workers of the mine. The moving, initially planned for the spring or summer 2018, has been delayed.

3. METHODS AND DATA COLLECTION

Quantitative information (measured and calculated energy and temperature data) and qualitative information (cultural value assessment) were discussed and analysed in a multidisciplinary framework in order to find appropriate measures for the energy retrofit of the studied buildings. The method used, as well as the multidisciplinary composition of the research group (architecture, civil engineering, building conservation), follows the recently approved European guidelines [5] which recommend a broad range of expertise and qualifications to address the complex task of improving the energy performance of historic buildings.

Cultural value assessments on the case studies are based on the understanding of heritage as socially constructed. The values produced over time by the interactions of the analysed heritage buildings with the surrounding society and environment, are personally interpreted by the authors, on the basis of their direct experience and perception of the buildings, of the official declarations of cultural interest and of the documentation collected on the buildings. In the case of the Rådhus in Piteå, the evaluations of three different building conservators, collected by Cruz [6], are also used as a basis for discussing different energy retrofit strategies.

In Piteå and Kiruna, the collection of quantitative data went on from December 2014 to September 2016. The energy supplied for space heating and domestic hot water was measured using a Saber energy meter (KYAB, Sweden) connected to the district-heating sub-station. Indoor and outdoor temperatures were measured using factory-calibrated sensors (range $-40\text{ }^{\circ}\text{C}$ to $+80\text{ }^{\circ}\text{C}$, accuracy $\pm 0.1\text{ }^{\circ}\text{C}$). All these measurements were complemented by thermographic surveys of the buildings performed using a FLIR T620bx thermal imaging camera (thermal sensitivity: $<0.04\text{ }^{\circ}\text{C}$, resolution: 640×480 pixels).

In Gällivare, energy use measurements are still ongoing while the thermal transmittance of walls and roofs (U-value) was measured by heat flux meters (expected accuracy on walls for 12h: $\pm 5\%$) and calculated according to the standard ISO 9869 [7]. In Kiruna the thermal transmittance of the different building components were calculated following the indications contained in the ISO 6946, ISO 13370, ISO 13789 standards..[8] [9] [10]

In Piteå, the airtightness of the building envelope of Gamla Rådhuset was measured using the European standardized fan pressurization method. [11] The air leakages were then localised with an infrared camera. Dynamic building energy simulations of Gamla Rådhuset were performed in IDA ICE advanced version 4.7 (Equa, Sweden). The simulations were carried out with ASHRAE weather data for Luleå, located 35 km away. The energy use for the existing building was calculated and validated with the measured energy use. The air permeability of the building envelope, the indoor temperatures, the heat exchanger efficiency and the ventilation air flows were set to measured values in the model. The input U-values, thermal bridges and geometries of the building envelope were estimated through drawings and onsite inspections. Internal heat gains from occupants and electrical appliances and lighting were based on drawings, schedules for occupant presence and onsite inspections.

4. FINDINGS AND DISCUSSION

4.1 HOW DOES THE PERCEPTION OF HERITAGE VALUES AFFECT ENERGY RETROFIT CHOICES?

Recent research has extensively explored the issue of integrating cultural value assessment into the process of improving the energy efficiency of heritage. [12] [13] [14] The EN16883:2017 [5] standard also deals with the problem of assessing the impacts of energy retrofit measures on heritage significance. Nevertheless, a recent work by Örn [15] has shown that research in this field often lacks a thorough discussion of the conservation theories which are at the basis of decisions and assessments. Örn suggests a decision support system for energy efficiency measures in heritage buildings integrating different conservation approaches: an *Objectivistic approach*, based on the ontological view of values being embodied within the material of an object, and a *Relative approach*, which understands values as being socially constructed when objects are perceived as socially or culturally meaningful.

As a matter of fact, the intrinsic subjectivity and relativity of this kind of assessments is a relevant issue. Even in the presence of a formal value evaluation

or a declaration by an authority, the perception of how the heritage values or significance are affected will change not only depending on the professional background or role of the actors involved, but even among actors with a similar background. Just considering the category of conservators, different understandings of conservation theories can result in very different evaluations of what is acceptable or not in relation to a change in the material authenticity or in the aesthetical appearance of the object.

This was the case of the panel of experts consulted about the most appropriate retrofitting strategy for the Rådhus in Piteå. A list of possible measures for improving the thermal performance of the building envelope was given to three building conservators: one from the Swedish association of professional building conservators (SPBA), one from the local planning authority, and one from the County Administrative Board of Norrbotten. They provided statements of what they thought of each proposed measure from a building conservation perspective. The measures (or combination of measures) that each expert considered to be appropriate were simulated as three different retrofitting scenarios, in order to quantify their potential energy savings. As showed in Table 1, the experts' answers on which of the measures they considered to be acceptable, lead to very different outcomes in the potential reduction of heating energy use. A fourth scenario is added as a reference to show the total reduction of heating energy use in case all the measures accepted by at least one of the experts were implemented.

Moreover, a comparison between the two buildings studied in Malmberget shows that also in the past value assessment could lead to different outcomes regarding preservation and energy performance. House 158 was heavily retrofitted in the 1960s, including the addition of insulating layers to improve its energy performances: an extra insulation of 50 mm of mineral wool was added to the exteriors

Table 1. Proposed energy retrofitting strategies for the Rådhus in Piteå

Scenario 1	Adding 250 mm mineral wool insulation to the attic				
Scenario 2	Adding 250 mm mineral wool insulation to the attic + addition of 70 mm insulation to the external walls + Changing the inner pane with "energiglas" with U value 1,8 W/(m ² .K) + improving the existing infiltration rate from 1,6 l/(s.m ²) to 1.2 l/(s.m ²)				
Scenario 3	Adding 250 mm mineral wool insulation to attic + replacing the existing door with improved door with U value 1,4 W/m ² .K + addition of 70 mm insulation to the basement walls + addition of 45 mm extruded polystyrene on the basement floor + changing the inner pane with "energiglas" with U value 1,8 W/(m ² .K) + existing infiltration rate 1.6 l/(s.m ²)				
Scenario 4	Adding 250 mm mineral wool insulation to attic + addition of 70 mm insulation to the external wall + Addition of 70 mm insulation to the basement walls + addition of 45 mm extruded polystyrene insulation on the basement floor + Changing the inner pane with "energiglas" with U value 1,8 W/(m ² .K) + improved door with U value 1,4 W/m ² .K + Improving the existing infiltration rate to 1.2 l/(s.m ²)				
	Base Case	Scenario1	Scenario 2	Scenario 3	Scenario 4
Heating energy use (kWh/m ² /year)	77,5	75,6	62,5	68	58
Total energy use (kWh/m ² /year)	132,7	130,7	117,6	123	113
Reduction in heating energy use (%)		2,4	19,3	12,2	25

and the external panelling was remade; 70 mm were added to the roof. On the contrary, in the house 420 the appreciation for its refined finishing and details, both in the interiors and in the exteriors, likely resulted in an opposite strategy: it is very well preserved and no measures for energy efficiency have been implemented.

The current energy performance of the houses, given by their energy declarations, and the measurements on field of the U-value confirm the difference. House 158 uses 195 kWh/m²/year and a typical thermal transmittance of the outer walls of 0.32 W/m²K was measured; in house 420 the corresponding values are 300 kWh/m²/year and 0.47 W/m²K. Both houses rise questions and doubts about the impact on cultural values of future proposals of energy retrofit. In one case, despite the very poor performance of the building in such a cold climate, the room for action will probably be very limited and every proposal will have to be considered very carefully. In the other case, the evaluation will focus on the cultural value of energy retrofit interventions from the past, and on whether to keep and upgrade them or to attempt a “de-restoration”, which could significantly affect the energy efficiency of the building.

4.2 DOING LESS, DOING MORE OR DOING NOTHING?

Both European directives and Swedish legislation allow exemptions from energy requirements when the cultural, architectural or aesthetical values are affected. [16] [17] [18] Both in Kiruna and Malmberget, this cautious approach was reinforced by the exemptions introduced in 2007 by the Government to avoid the risk of what was referred to as “cultural destruction” [19]. This could occur when large numbers of historical buildings are to be moved and rebuilt in a new place and, according to the previous law, they would have to meet present-day building requirements. The fear was also that this would have caused a rent increase for the tenants. In both cities, these were among the main reasons why energy retrofit measures are not included within the moving process, and will not be implemented.

In the case of Kiruna, the need for a deeper energy renovation of its existing building stock was shown by Johansson and others [20]. They calculated that the ongoing transformation could allow the town to meet the Swedish national energy reduction target for 2050, but only by replacing all the buildings affected by the mining activities with new ones that achieve the passive-house standard. Of course, meeting such a high performance level would be impossible for a heritage building. Nevertheless, giving up on improving the energy performance of Kiruna’s Bläckhorn houses exemplifies a typical situation where doing nothing is maybe the safest option, but not the absolute best when considering other societal needs.

In an earlier paper [21], the authors have proposed an energy retrofitting strategy for the building envelope of the Bläckhorn house B52, starting from a cultural value assessment to identify the character-defining elements of the building. The measures proposed in Table 2 are meant to: a) minimize the impact on the character defining elements, i.e. the shape, materials and finishing of the

Table 2. Proposed interventions for house B52 in Kiruna (adapted from Luciani et al. 2017)

Building elements	Thermal transmittance (W/m ² K)		Description of the proposed refurbishment measures	Contribution to reducing total thermal transmittance	Estimated savings of heating energy use
	Before	After			
Attic (timber frame structure)	0.39	0.17	Removal of sawdust fill and addition of 300 mm cellulose loose-fill insulation	5 %	4 %
Outer wall (paneled timber log structure)	0.48	0.30	Addition of 50–80 mm wood fibre insulation board to the inner side	9 %	7 %
Basement (1960s concrete structure)	0.93	0.27	Change to ventilated crawl-space basement with 100 mm foam insulation	39 %	31 %
Windows (triple pane, wood frame)	2.1	1.2	Addition of secondary glazing	6 %	4 %
Doors	1.4	1.4	No changes applied	0 %	0 %
Linear thermal bridges	0.062	0.044	Estimated improvements due the proposed measures	2 %	1 %
	Average: 0.77	Average: 0.30	All changes of individual elements implemented	60 %	48 %

exteriors and the timber structure; b) add new elements that reflect contemporary needs in the most compatible and reversible way (e.g. the addition of insulation and secondary glazing to the inner side of the walls); and c) optimize the life cycle of the existing building components, even when not original (e.g. the windows). Furthermore, they are based on rather inexpensive and accessible technologies and they can be easily added to the usual renovation works required by the moving of the house in its new location.

It must be underlined that a large part of the energy savings come from the substitution of the existing basement floor with an insulated and ventilated crawlspace, which is a consequence of the movement of the building. All other measures proposed for the building envelope are nevertheless estimated to lower the heating energy use of around 15–20 percent. This example shows that a sound retrofit strategy can enlarge the room for action for the energy retrofit of traditional timber buildings, and overcome a precautionary over-use of exemptions.

4.3 UNDERSTANDING THE OPPORTUNITY AND ECONOMIC VIABILITY OF ENERGY RETROFITS IN COLD CLIMATES

In a demanding cold subarctic climate, improving the energy performances of historic buildings can be a key-factor to ensure their preservation, and particular attention should be paid to limit the heat losses through the building envelope. This context thus offers interesting opportunities because even an intervention not so invasive on heritage values can help to save a comparatively higher amount of energy. Most of the cases discussed in this paper are facing the extraordinary situation of being moved due to the ground deformations caused by

mining activities. It is worth mentioning that, in an early stage of the process, the poor energy performances of these buildings (and the operational costs implied) were quoted among the reasons for which their demolition and substitution with new buildings could be considered a preferable and less expensive option, compared to their moving and preservation [22].

As already mentioned, at present no particular energy saving measures are planned for the buildings that have been (or are going to be) moved, because of the exemptions they can have and, supposedly, for budget restrictions and other economic reasons. In the authors' opinion, nevertheless, implementing energy retrofit measures in this phase, especially on the building envelope, could be a winning option to increase the economic, environmental and social sustainability of the whole operation. Of course, the implementation of the measures would come at an additional cost, but the increase should not be so high in perspective, considering all the other operations and interventions of renovation that are already implied in the movement of the buildings. Hopefully, the results from this research will give the real-estate company that owns the buildings a good incentive to make energy efficiency measures.

In a cold climate, better energy performances should have a higher impact in lowering operational costs [23], thus reducing their payback time, but this hypothesis needs to be verified with a more accurate assessment of the life-cycle costs of the operations described [24]. In the long term, however, lower operational costs could contribute to pay back to the owner part of the whole investment for moving the building or to lower the rent of the apartment for the tenants. A further consideration is valid also for heritage buildings in more common situations: saving in heating energy use means that in the long term more budget can be allocated into building maintenance and preservation actions.

5. CONCLUSIONS

Sound strategies for the retrofit of the envelope of heritage buildings, such as those proposed in the paper, could save a consistent amount of energy in the timber buildings analysed in the project, but a key issue is still how to integrate in the process the complex operation of assessing the impacts of energy saving measures on cultural values.

This paper has shown that cold climates offer interesting opportunities for improving the energy efficiency of valuable historic buildings. Unfortunately, this potential is often left unexplored because other factors come into play, such as exemptions, budget restrictions or an unclear understanding of which measures are acceptable or not from a heritage perspective. The next steps of the project will thus focus primarily in implementing and disseminating tools that can help stakeholders, particularly owners and authorities, in understanding these opportunities.

6. REFERENCES

- [1] Länsstyrelsen i Norrbottens Lan. Beslut 1994-02-04, 221-6518-93. Beslut om byggnadsminnesförklaring av f d Rådhuset, kv Stadsvapnet 1, Rådhus-torget, Piteå Kn, Norrbotten. Luleå: Länsstyrelsen, 1994.
- [2] Riksantikvarieämbetet (2013) Riksintressen för kulturmiljövården. Norrbot-tens län (BD). [Online] Available: https://www.raa.se/app/uploads/2013/09/BD_riksintressen.pdf [Feb. 08, 2018].
- [3] L. Brunnström. Kiruna – ett samhällsbygge i sekelskiftets Sverige. Umeå: Umeå universitet, 1981.
- [4] Riksantikvarieämbetet. Reviderad riksintressebeskrivning för Kiruna-Kiruna-vaara [BD 33] (Kiruna stad, Jukkasjärvi sn) 2010-05-19, dnr 331-00556–2009. Stockholm: Riksantikvarieämbetet, 2010.
- [5] EN 16883:2017. Conservation of cultural heritage – Guidelines for improv-ing the energy performance of historic buildings. Brussels: European Com-mittee for Standardization, 2017.
- [6] R. Cruz. Byggtekniska åtgärder för energieffektivisering av kulturhistorisk värdefull byggnad: En fallstudie av Gamla rådhuset i kvarteret Stadsvapnet 6, Piteå (Master Thesis). Luleå: Luleå tekniska universitet, 2014.
- [7] ISO 9869-1:2014. Thermal insulation. Building elements. In-situ measure-ment of thermal resistance and thermal transmittance. Part 1: Heat flow me-ter method. Geneva: International Organization for Standardization, 2014.
- [8] ISO 6946:2017. Building components and building elements – Thermal re-sistance and thermal resistance calculation methods. Geneva: International Organization for Standardization, 2017.
- [9] ISO 13370:2007. Thermal performance of buildings – Heat transfer via the ground calculation methods. Geneva: International Organization for Stand-ardization, 2007.
- [10] ISO 13789:2017. Thermal performance of buildings – Transmission and ventilation heat transfer coefficients calculation methods. Geneva: Interna-tional Organization for Standardization, 2017.
- [11] EN 13829:2001 Thermal performance of buildings, Determination of air permeability of buildings, Fan pressurization method. Geneva: International Organization for Standardization, 2001.
- [12] E. Gigliarelli, C. Bacigalupo, A. Cerqua and L. Cessari. “Multicriterial Approach for the Evaluation of the Compatibility of Energy Projects in Historical Buildings by the AHP Method.” in *Science and Technology for the Safeguard of Cultural Heritage in the Mediterranean Basin*, 2009, pp. 113–17.
- [13] C. Franzen and A. Troi. “Position Paper on criteria regarding the assess-ment of energy efficiency measures regarding their compatibility with con-servation issues.” Internet: http://www.3encult.eu/en/project/work_packages/energyefficientsolutions/Documents/3ENCULT_3.2%3d2.2.pdf, May 25, 2011 [Feb. 21, 2018].
- [14] P. Eriksson, C. Hermann, S. Hrabovszky-Horváth and D. Rodwell. “EFFESUS Methodology for Assessing the Impacts of Energy-Related Retrofit Measures on Heritage Significance”. *The Historic Environment*, Vol. 5(2), pp. 132–49, Jul. 2014.

- [15] T. Örn. *Energy Efficiency in Heritage Buildings. Conservation Approaches and Their Impact on Energy Efficiency Measures* (Licentiate Thesis). Luleå: Luleå University of Technology, 2018.
- [16] European Union. "Directive 2010/31/EU of the European Parliament and of the Council of 19 May 2010 on the energy performance of buildings." *Official Journal of the European Union*, L 153/13, Jun.18 2010.
- [17] Sveriges Riksdag. "Plan- och bygglag. SFS 2010:900." Internet: http://www.riksdagen.se/sv/dokument-lagar/dokument/svensk-forfattningssamling/plan-och-bygglag-2010900_sfs-2010-900 [Feb. 21, 2018].
- [18] Boverket. CBoverkets byggregler. BFS 2011:6 med ändringar t.o.m. BFS 2017:5." Internet: https://www.boverket.se/contentassets/a9a584aa0e564c8998d079d752f6b76d/konsoliderad_bbr_bfs_2011-6.pdf [Feb. 21, 2018].
- [19] Regeringen. "Lagrådsremiss. Möjlighet till undantag från de tekniska egenskapskraven på byggnadsverk." Internet: <http://www.regeringen.se/49bb9b/contentassets/eae8c6faa1ee41aabb6992cd8d3df87f/mojlighet-till-undantag-fran-de-tekniska-egenskapskraven-pa-byggnadsverk>, Jul. 01, 2007 [Feb. 21, 2018].
- [20] T. Johansson, M. Vesterlund, T. Olofsson, and J. Dahl. "Energy performance certificates and 3-dimensional city models as a means to reach national targets – A case study of the city of Kiruna". *Energ Convers Manage*, Vol. 116, pp. 42–57, Feb. 2016.
- [21] A. Luciani, S. Lidelöw, S. Bhattacharjee and T. Örn. "The challenge of energy efficiency in Kiruna's heritage buildings." *Cold Climate HVAC* 2018. In press.
- [22] J. Sjöholm. *Heritagisation, Re-Heritagisation and De-Heritagisation of Built Environments. The Urban Transformation of Kiruna, Sweden* (Doctoral Dissertation). Luleå: Luleå University of Technology, 2016.
- [23] F. Bonakdar, A. Sasic Kalagasidis and K. Mahapatra. (2017, May). "The Implications of Climate Zones on the Cost-Optimal Level and Cost-Effectiveness of Building Envelope Energy Renovation and Space Heat Demand Reduction." *Buildings*. [Online]. Vol. 7(2). Available: doi:10.3390/buildings7020039 [Feb. 21, 2018].
- [24] T. Broström, P. Eriksson, L. Liu, P. Rohdin, F. Ståhl and B. Moshfegh. "A Method to Assess the Potential for and Consequences of Energy Retrofits in Swedish Historic Buildings". *The Historic Environment*, Vol. 5(2), pp. 150–66, Jul. 2014.

Categorization of the heritage building stock in Cairo for the energy planning purposes

A method and the typical buildings

E. Raslan¹, A. Donarelli² and E. De Angelis¹

¹ Department of Architecture, Built environment, and Construction Engineering, Politecnico di Milano, Milan, Italy. Email: ehsan.omar@polimi.it, enrico.deangelis@polimi.it.

² Department of Art History, Uppsala University, Visby, Sweden. Email: anna.donarelli@konstvet.uu.se.

Abstract – Categorization of a building stock into representative categories is a method to suggest retrofitting scenarios to reduce the energy consumption on a district scale. In Cairo, there are 3305 residential buildings with heritage values that need to be rehabilitated. Furthermore, the residential sector consumes 44 percent of the total electricity production in Egypt according to International Energy Agency. Therefore, the rehabilitation strategies should balance between energy and conservation issues. The aim of this paper is to test a recent categorization method to classify 592 and 176 heritage buildings in Al Darb Al-Ahmar and Cairo Downtown areas respectively. The building inventory, categorization processes, and representative typical building selection are discussed. Four and nine categories are extracted in each area, respectively. The discussion includes the building inventory issues encountered when working with the heritage buildings in Cairo, and suggestions on how to adapt the method for different contexts.

Keywords – categorization of heritage buildings, the Visby method, building inventories, typical building, Cairo historic districts

1. INTRODUCTION

In 2015, the residential sector in Egypt consumed 44 percent of the total electricity demand [1]. The electricity consumption growth for the residential sector between 1998 and 2008 has been estimated between 7–10 percent a year. Between 2018 and 2030, the total residential units are expected to increase by 76 percent. Consequently, the electricity consumption for them is expected to increase by 47 percent. On the other hand, the residential sector has a potential to save 5–15 percent of the electricity end-use by applying energy saving strategies [2].

Cairo, the capital of Egypt, is an ancient city that has historic buildings from different eras dating back to the 7th century. The building stock in Cairo consists of more than 688,000 buildings, 87 percent of which are residential buildings. According to The National Organization for Urban Harmony (NOUH) in Egypt, there are 3300 residential heritage buildings located in the Cairo governorate [3]. The heritage value of a building can be represented in an architectural style, national history or historical figure and epoch [4]. Those buildings need a strategy to be retrofitted and preserved [5].

Categorizing a building stock into several representative categories is an effective method to (a) explore the energy performance and reduce CO₂ emissions for a very large number of buildings; (b) set a successful strategy to reduce the energy consumption [6]; (c) introduce mandatory measures for building energy retrofits; (d) evaluate the potential of using new technologies; (e) develop suitable energy efficiency policies and regulations [7]; (f) address the economic effects of different CO₂ emission reduction strategies over time; (g) set a sustainable energy efficiency strategy that balances between energy saving and building conservation in historic districts.

The aim of this study is to test a method for categorisation that can sequentially be used as a tool to estimate the energy consumption of the heritage buildings in Cairo. In addition, the selected typical buildings in each category will be used to suggest retrofitting measures for energy saving which take in consideration the cultural values of the buildings. Those measures will provide the energy saving potentials in the building stock in Cairo in the coming studies.

For achieving this aim, a recent method used in Visby, Sweden, for categorizing the buildings in an historic district, was selected to analyse two historic districts in Cairo. They are Al Darb Al Ahmar and Cairo downtown. Mainly, the historic buildings, significant from architectural and historical points of view, listed by NOUH and Aga Khan Trust for Culture (AKTC) [8], were selected for categorisation in both areas. Four and nine categories are extracted in each area, respectively. Categorization is a method that has many advantages to analyse and improve the energy performance of a large building stock.

2. LITERATURE REVIEW

Several studies have shown how building stocks can be broken down into a limited number of representative building categories. This literature review shows a variety of typologies and categorisation methods.

The EU-project TABULA developed residential building typologies for the partner countries in 2012, to use for calculations on energy saving [4], [5]. The typologies are based on size, climate zone and age. Typical buildings were chosen to represent the national building stocks. For the typical buildings information on geometrical data, the construction and the heating system was collected where available. The method aimed at making the outcome comparable between countries.

Another method for assessment of energy use in national building stocks is ECCABS (Energy, Carbon and Cost Assessment for Building Stocks) [10]. It is a bottom-up model to assess energy-saving measures and CO₂ mitigation strategies in national building stocks. The parameters for categorisation were: use, number of floors, connections to other buildings, construction year (related to building regulations and construction techniques), heating system and climate zone. The results showed satisfactory when comparing modelled energy data based on the typical buildings with statistics, which means the typical buildings are representative of the building stock.

For use on smaller and more homogeneous building stocks a method called Statistical Distribution of Buildings according to primary Energy use for heating (E-SDOB) has been developed [11]. The aim is to provide a basis for regional energy planning. The building categories were identified through number of floors, connections to other buildings, age, efficiency of heating system, and degree days. A case study in Italy resulted in 72 categories, and comparing the modelled data with energy statistics showed a good reliability.

Another method was developed as part of the Energy Efficiency for EU Historic Districts' Sustainability (EFFESUS) project [12] and tested on the town Visby in Sweden as part of a national project [13]. The focus was historic buildings and the aim was to facilitate an energy analysis of an historic urban district. The buildings were categorised according to the number of floors and connections to other buildings, with additional data on heated area, calculation of volumes and division between construction types. It provided basic data for further studies on energy saving potential combined with vulnerability assessment in an historic building stock.

Some of the described studies have looked at national building stocks, others on districts or smaller areas. What the studies have in common is the aim of providing a basis for analysis of energy use and saving potential, and the use of similar input data. All studies stress the importance of qualitative building data. The categories have in the previous studies been represented by selected (existing) or modelled buildings for detailed analyses on energy saving potential in relation to different targets. The results can be used for extrapolation to represent the building stock of a large or small area, and can thus be used for planning purposes. Climate zone is not used for the categorisation in the case of smaller areas where all buildings belong to the same zone. Age as a parameter for categorisation was not considered important in the case of Visby, instead all buildings were defined as historic, since they were all located in a protected part of the historic town.

3. CASE STUDIES

3.1 LOCATION OF THE CASE STUDIES

The buildings selected for categorisation in Cairo are only the buildings with cultural values. They are located in two separate areas in the city, with different characteristics in terms of buildings size, age and density. Since the areas are small, the buildings have a cultural value and the building stocks are quite homogeneous in both areas, it was decided to test the method for categorisation used in Visby [13].

3.2 AL DARB AL AHMAR

Al Darb Al Ahmar is located in the central part of Historic Cairo which is one of the major world heritage sites, see figure 1. It covers an area of 1.2 km² [17]. It is characterized by a densely built up residential fabric [18]. There are 100,000 inhabitants in Al Darb Al Ahmar, [19]. The buildings are built around courtyards

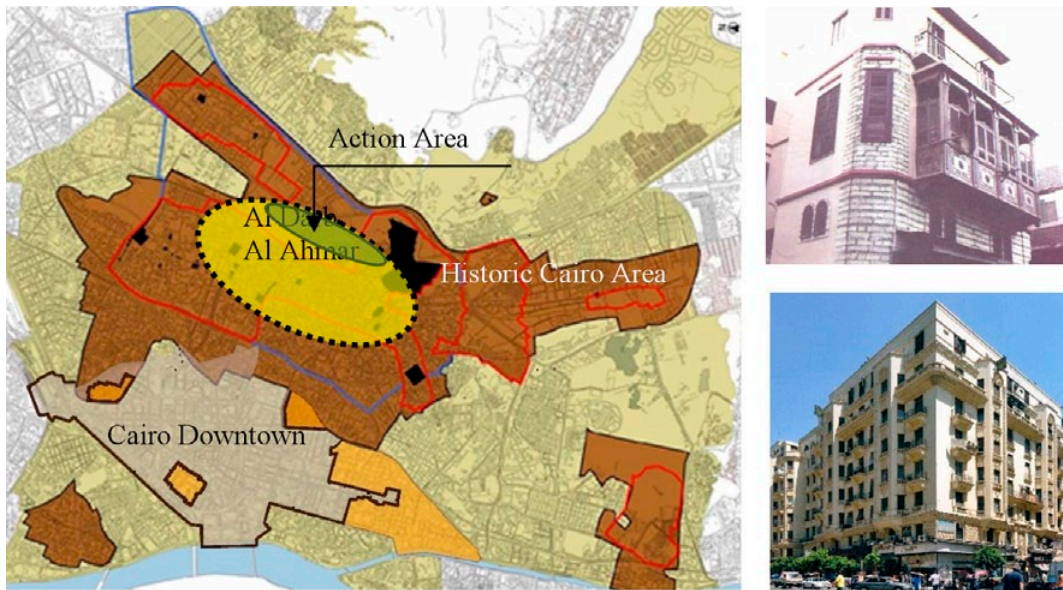

Figure 1. Boundaries of Historic Cairo as per UNESCO-URHC (Brown color) [14]; Al Darb Al Ahmar and the action area (yellow and green colors); Cairo downtown as per NOUH (grey color). The top right photo represents 19th century houses in Al Darb Al Ahmar, the downright photo represents 19th century houses in Cairo Downtown [15] [16].

in irregular shapes occupying a small ground floor area. There is a lack of data about the exact construction year of the buildings in Al Darb Al Ahmar, but the whole area was constructed between the 11th and 18th centuries. Several old buildings have been replaced by modern buildings [20].

In 1997, AKTC proposed a project called “Al Darb Al Ahmar Housing Rehabilitation Program” to rehabilitate the buildings in the “Action area” that is adjacent to the Ayyubid wall [19], [8]. The selection of buildings was based primarily on a set of criteria that included the historic and the architectural values of the buildings, structural conditions, proposed intervention forms and construction techniques [21]. Analysing the building stock in the action area shows that the total number of the buildings that need conservation actions is 592, in which 293 buildings are residential; 187 buildings are predominantly residential; and 112 buildings are used for different purposes. In this paper, the building categorization focuses on the conservation interventions that have been suggested by AKTC for those 592 buildings.

3.3 CAIRO DOWNTOWN

The Nile River is adjacent to Cairo Downtown on its west side; meanwhile the Historic Cairo area is located on the east side. It covers an area of 4.5 km². This area was constructed during the reign of Khedive Ismail in the 19th century. It was built according to a Parisian Haussmannian model with wide streets and shopping arcades on the ground floors [22]. The Egyptian building law no. 119/2008 defined special borders for conserving the area of Cairo Downtown due to its historic value, see figure 1 [4]. In this paper, the building categorization focuses on the residential heritage buildings that have been registered by NOUH.

4. METHOD

The method used for the categorisation of the building stock in Visby involves three steps; building inventory, categorisation and selection of typical buildings. Data needed for this categorisation are number of floors, area and connections to other buildings. When the data has been compiled, the buildings are categorised in the following steps: 1) number of floors, 2) number of connections to other buildings, i.e. detached (D), semi-detached (S.D.) and terraced (T). The data on areas and number of floors are used to calculate the volume (based on standard floor heights). Volume is then used to exclude outliers if the buildings within the group vary too greatly. As a last step, typical buildings are selected in the different categories based on average size. Additional data on, for example, typical construction types, layouts and age, are then used to better describe the typical buildings.

Al Darb Al Ahmar and Cairo Downtown were selected, and the building inventories were done separately. Only buildings pointed out as significant from a heritage point of view were registered in the data collection phase. Hence, delimitation was done already to begin with. Cairo Downtown was represented by 176 buildings and Al Darb Al Ahmar by 592. Data on building area, age, use and number of no. of floors, were registered, based on inventories done by Central Agency for Public Mobilization and statistics (CAPMS) [23], NOUH, AKTC, and Urban Regeneration for Historic Cairo project (URHC) in 1993, 2006, data from 2004/2008 and 2014. Data reliability is considered to be good, because comparative studies of the available inventories were done by the authors. In addition, the recent data about the buildings were taken into consideration during the categorization phase. The buildings' heights are calculated using assumptions on floor heights.

The buildings in the two areas were categorised according to number of floors and connections to other buildings. In Al Darb Al Ahmar a delimitation was needed, in order to remove outliers. Standard deviation gave negative values because the variations were not normally distributed. Still, in order to obtain a comparable group of buildings, it was decided to delimit using the 95th and 5th percentile. In Cairo downtown no delimitation was done, because the buildings were few but large and thereby important from an energy point of view. A weight is given to each category based on the percentage in volume it represents within the total building stock.

Typical buildings from each category were determined by using average values on size (volume). In Al Darb Al Ahmar this was done after delimitation and the creation of modelled typical buildings was tested. In Cairo Downtown, another approach was chosen and the typical buildings representing each category were selected among the actual buildings.

5. RESULTS

5.1 AL DARB AL AHMAR CATEGORISATION

In the action area in Al Darb Al Ahmar, see figure 1, the Visby method was used for categorising the historic building stock. Three kinds of buildings were selected

in the action area; buildings that need rehabilitation actions, buildings that need restoration actions due to their cultural values, and monuments that need restoration actions. The building inventory by AKTC, NOUH, and UNESCO-URHC was coordinated for those buildings.

The first step categorized the number of storeys; the second the number of adjoining walls. The third step included the calculation of the average volume for each category. For this last step, the area of the courtyards in those buildings was excluded and the height of each floor was assumed as three meters.

Table 1 shows the results of the heritage building stock categorizations. Four main categories were extracted.

Table 1. The outcome of categorization of the building stock in the action area of Al Darb Al Ahmar

Category	Categorization after delimitation (The total no. of the buildings= 509)			
	Category (1)	Category (2)	Category (3)	Category (4)
No. of the buildings	9	284	13	203
No. of floors	1-2 storeys	1-2 storeys	3-6 storeys	3-6 storeys
Adjoining walls	Semi-Detached	Terraced	Semi-Detached	Terraced
Avg. volume(m ³)	759	453	689	745
Avg. area (m ²)	207	91	75	76

Typical buildings were chosen according to the average area and average volume of the buildings in each category, as shown in Table 2. Typical buildings were selected to create a typical shape that tries to sort the irregular shapes and to represent the buildings in each category.

Table 2. The outcome of selecting typical building in each category in Al Darb Al Ahmar

Category	Representative buildings for creating a model)			
	Category (1)	Category (2)	Category (3)	Category (4)
No. of floors	2	2	3	3
Adjoining walls	S.D.	T.	S.D.	T.
Volume(m ³)	820	459	675	760
Area (m ²)	137	76	75	84
Type of construction	Modern (reinforced concrete)	Traditional (load bearing masonry wall)	Modern (reinforced concrete)	Traditional (load bearing masonry wall)

5.2 CAIRO DOWNTOWN CATEGORISATION

CAPMS, NOUH, Google earth maps, and books such as “Khedivial Cairo Book”, are the main sources to collect the data about the heritage residential buildings in Cairo Downtown. CAPMS produces maps for the land use of the buildings in Cairo. These maps were created in 1993, and were used to locate the residential heritage buildings. The use of the Google map was thus necessary to check the current status of the buildings and their vicinities. The NOUH determined the borders of Cairo Downtown and published a list of the heritage buildings.

Based on the available information, 176 residential heritage buildings were selected. Due to the absence of data for the height of each floor, three meters height for each floor was assumed as per the author observation for the average floor heights in Cairo Downtown. In addition, the new floors that were added in the 20th century were excluded from the total number of floors.

The delimitation in order to remove outliers was not needed in this case due to the limited number of buildings. In addition, the volume of the buildings was significant and would have a great impact on the energy demand. According to these criteria, nine categories were extracted as shown in Table 3.

Table 3. The outcome of categorization of the residential heritage building stock in Cairo Downtown

Category	Categorization without delimitation								
	(1)	(2)	(3)	(4)	(5)	(6)	(7)	(8)	(9)
No. of the buildings	7	11	12	65	34	28	7	6	2
No. of floors	1-4	1-4	1-4	5-8	5-8	5-8	9-13	9-13	9-13
Adjoining walls	D	S.D.	T.	D.	S.D.	T.	D.	S.D.	T.
Avg. vol. (m ³)	11074	13588	11795	25718	22177	13302	38252	42042	60876
Avg. area (m ²)	1048	1445	1178	1340	1110	715	1310	1190	3134
(%) from total vol.	4.6 %	5.6 %	4.9 %	10.7 %	9.2 %	5.5 %	16 %	17.6 %	25.4 %

Typical buildings were chosen based on the average area and average volume of the buildings in each category, as shown in Table 4. In the case of Cairo Downtown, real representative case study buildings were selected due to the regular shapes of those buildings and the available information about them.

Table 4. The outcome of selecting representative building in each category in Cairo Downtown

Category	Categorization without delimitation								
	(1)	(2)	(3)	(4)	(5)	(6)	(7)	(8)	(9)
Year of construction	1928	Half of 19th C.	First of 20th C.	End of 19th C.	1913 -1928	First of 20th C.	1934	1961	1939
No. of floors	4	4	4	5	6	7	10	9	10
Adjoining walls	D.	S.D.	T.	D.	S.D.	T.	D.	S.D.	T.
Volume (m ³)	17280	14780	10668	26672	22590	13230	32190	37174	74052
Area (m ²)	1440	1232	889	1778	1255	630	1073	1377	2468
Type of construction	M.	M.	M.	M.	M.	M.	M.	M.	M.

6. DISCUSSION

In Cairo only a small portion of buildings in the building stock was studied, they were selected due to their cultural values, which had been defined by UNESCO, NOUH, and AKTC. Because the two areas of Cairo that were studied are so different, it was decided to categorise them separately, in order to obtain a better level of detail for both areas.

Using the Visby methodology in Cairo requires certain preparation. That includes discussing the aim of the categorization and the percentage of available data to achieve this aim. In addition, describing the characteristics of the building stock should be done. Defining the characteristics of the buildings will help creating the criteria to calculate the window to wall (WWR) and surface to volume (S/V) ratios that match the Cairo context. Those ratios are used to calculate the heat exchange and energy demand in the typical buildings that represent each category.

The building stock categorisation is based on available data from different sources. The building data was mostly available on different maps, from which it was compiled in one matrix. The quality of the data is important for the outcome of the categorisation. In the case of Cairo, the data used was considered reliable and relatively updated. However, it would have been useful to combine the data with in situ observations for determining e.g. average floor heights, S/V, WWR ratios and to check the construction techniques. In this preliminary study that was not possible.

Building inventories of Cairo Downtown and Al Darb Al Ahmar are divided among different organizations. The available data in each organization has been issued on different dates. Thus, coordination and updating the maps for the research purposes are crucial to get more reliable results. This coordination was done in this article using the available data, however, the coordination should consider the actual situation of the building stock. For example, the number of floors that were added to the original construction system in Cairo downtown should be clear on the maps. In addition, the old buildings that were replaced by modern constructions in the case of Al Darb Al Ahmar, should be mentioned clearly.

7. CONCLUSION AND FUTURE RESEARCH

Categorization the heritage building stock in Cairo Downtown and Al Darb Al Ahmar is the first attempt to break down those densely built up areas into several representative categories for energy planning purposes. Further studies will be based on determining the S/V ratio and WWR for the typical in Al Darb Al Ahmar district. In addition, the energy performance assessment for the typical buildings in Cairo Downtown will be simulated. The result of this study will be used to understand the feasibility of energy retrofit of the heritage buildings in Cairo.

8. REFERENCES

- [1] A. F. Radwan, A. A. Hanafy, M. Elhelw, and A. E. A. El-sayed, "Retrofitting of existing buildings to achieve better energy-efficiency in commercial building case study: Hospital in Egypt," *Alexandria Eng. J.*, vol. 55, no. 4, pp. 3061–3071, 2016.
- [2] P. Bampou, "Green buildings for Egypt: a call for an integrated policy," *Int. J. Sustain. Energy*, vol. 36, no. 10, pp. 994–1009, 2017.
- [3] "National Organization for Urban Harmony in Egypt." [Online]. Available: http://urbanharmony.org/ar_rules.htm
- [4] H. Fahmy, "Egyptian legislations in relation to the rehabilitation of Historic Cairo," World Heritage Centre – Urban Regeneration for Historic Cairo, 2013.

- [5] L. M. Khodeir, D. Aly, and S. Tarek, "Integrating HBIM (Heritage Building Information Modeling) Tools in the Application of Sustainable Retrofitting of Heritage Buildings in Egypt," *Procedia Environ. Sci.*, vol. 34, pp. 258–270, 2016.
- [6] E. G. Dascalaki, K. G. Droutsas, C. A. Balaras, and S. Kontoyiannidis, "Building typologies as a tool for assessing the energy performance of residential buildings – A case study for the Hellenic building stock," *Energy Build.*, vol. 43, no. 12, pp. 3400–3409, 2011.
- [7] A. Sharma and B. M. Marwaha, "A methodology for energy performance classification of residential building stock of Hamirpur," *HBRC J.*, vol. 13, no. 3, pp. 337–352, 2015.
- [8] AKTC and H. C. S. Programme, "Cairo: Urban Regeneration in the Darb Al-Ahmar District," 2005.
- [9] I. Ballarini, S. P. Corgnati, and V. Corrado, "Use of reference buildings to assess the energy saving potentials of the residential building stock: The experience of TABULA project," *Energy Policy*, vol. 68, pp. 273–284, 2014.
- [10] A. S. Kalagasidis and F. Johnsson, "Building-stock aggregation through archetype buildings: France, Germany, Spain and the UK," *Build. Environ.*, vol. 81, pp. 270–282, 2014.
- [11] G. Vincenzo and M. Serraino, "A methodology for assessing the energy performance of large scale building stocks and possible applications," *Energy Build.*, vol. 43, no. 4, pp. 844–852, 2011.
- [12] F. Berg, E. Genova, and T. Broström, "Interdisciplinary building categorization—A method to support sustainable energy efficiency strategies in historic districts," 2016, pp. 41–48.
- [13] T. Broström, A. Donarelli, and F. Berg, "For the categorisation of historic buildings to determine energy saving," vol. 9309, pp. 135–142, 2017.
- [14] "UNESCO World Heritage Centre—Management of World Heritage Sites in Egypt Urban Regeneration Project for Historic Cairo," 2012.
- [15] S. Z. Said, *19th Century houses of old Cairo quarters*. 2009.
- [16] P. Barbara and V. Capresi, *Discovering Downtown Cairo: Architecture and Stories*. JOVIS Verlag GmbH, 2015.
- [17] UNESCO-URHC, "UNESCO World Heritage Centre—Management of World Heritage Sites in Egypt Urban Regeneration Project for Historic Cairo," 2014.
- [18] F. SIRAVO, "Urban Rehabilitation and Community Development in al-Darb al-Ahmar," in *Present: A Comprehensive Approach*, Archnet, pp. 177–193.
- [19] K. Ibrahim, "Urban regeneration of historic Cairo project housing rehabilitation study historic Cairo," Cairo, 2011.
- [20] S. El Rashidi, "The History and Fate of al-Darb al-Ahmar.pdf." Archnet, pp. 55–65.
- [21] S. Z. Hawas, "Urban conservation- Regeneration of heritage areas in Egypt- Aga Khan Darb Al-Ahmar Project Model." Aga Khan Trust for Culture, 2013.
- [22] E. Quarter, "Reclaiming Cairo ' s downtown district," vol. 32, no. November 2008, 2010.
- [23] Central Agency for Public Mobilization and Statistics, "Central Agency for Public Mobilization and Statistics," *Egypt in Numbers 2015*, no. 2915. 2015.

On the use of change-point models to describe the energy performance of historic buildings

P. Rohdin¹, V. Milic¹, M. Wahlqvist² and B. Moshfegh¹

¹ Division of Energy Systems, Department of Management and Engineering (IEI), Linköping University, Sweden.

² Department of Art History, Uppsala University Campus Gotland, Visby, Sweden.

Abstract – The building and service sector accounts for nearly 40 percent of total energy use in Sweden, where the existing and historic building stock constitutes a large part of that use, and is therefore an important part of the national pursuit to reduce energy use. Information on energy performance and other key statistics related to this group of buildings is found in the database connected to the National Energy Audit Program for Buildings (Gripen). However, in order to understand performance and the possibilities for implementing cost-efficient energy efficiency measures, additional detailed information is needed.

The aim of this paper is to describe the method and use of a change-point model when describing the performance of buildings in terms of thermal performance, total energy use and power demand. Information about supplied heat will be input for a change-point model (i.e. energy signature), which enables an approximation of the temperature dependency of the building, total loss term ($W/^\circ C$) and temperature independent base load (W). The conclusion of the paper is that a change-point model is an effective way to describe a building's energy performance. This is because it provides additional information compared to the specific energy use in kWh/m^2 (A-temp) reported in Gripen. This information is related to the building's total loss term, Q_{tot} , as well as balance temperature, and an approximation of the used hot tap water and heat for hot tap water circulation.

Keywords – Change-point model; Energy efficiency; Historic buildings.

1. INTRODUCTION

More than 40 percent of the residential buildings in Europe were built before the 1960s when the regulations for energy performance were less strict. On a national level, the built environment in Sweden has a large share of historic buildings compared to most other countries in the EU, as 15 percent of all multi-family buildings and 27 percent of all single-family houses were built before 1945. The European Energy Efficiency Directive (EED) and the National Renovation Strategy need to include detailed information about the national building stock, focusing on the need for renovation and energy use. This directive also influences many historic buildings. The renovation strategy emphasizes that it is important to identify the connection between renovation and energy efficiency measures and how to achieve sustainability requirements, according to the Swedish Building Code (PBL), in the building stock. One main problem is the lack of detailed data that can describe the performance of buildings, before as well as after renovation. Presently, average values of key performance indicators (KPI), e.g. kWh/m^2 , are

gathered in databases such as Gripen. One novel approach is to use change-point models based on detailed data acquired from the energy suppliers. Power change-point models, also called P-signature or energy signatures, are a method to describe a building's energy performance. The same type of method is also used by district heating companies to describe the heat demand of the connected buildings as a function of outdoor temperature on an aggregated level.

The aim of this paper is to describe the use of a change-point model when describing the performance of historic buildings in terms of thermal performance, total energy use and power demand.

2. THEORETICAL BACKGROUND

2.1 CHANGE-POINT MODELS

Change-point models are becoming more and more of interest as the availability of measured data with high time resolution is increasing. One of the earlier articles on this topic is Hammarsten (1987). He describes how a change-point model for building performance can be modelled, how the time resolution of the included measurements affects the result, and how a model can be supplemented with parameters for solar and wind impact. The conclusion is that a change-point model is a good tool for estimating energy use.

Another major change is that information on energy use in buildings has gone from being used mainly for invoices to being part of the analysis of building energy performance and the validation of energy conservation measures. Claridge (1992) describes how energy use data can be presented to see whether the building's energy systems are functioning properly, evaluate energy efficiency measures and investigate whether energy use can be reduced by changing the system's regulation. In ASHRAE (2002), a list of guidelines for the process of change-point models, based on two to five parameter breakpoint models, is presented. Comfort cooling is usually modelled with two parameters (slope and breakpoint on the y-axis), while heat demand is measured with three parameters (slope, breakpoint and temperature independent base load), but may also have a fourth parameter for slope after the balance temperature, if there is a heat recovery system. A building with both heat and comfort cooling is modelled with five parameters (two slopes, two break points and a base load). The presented models are illustrated in Figure 1.

In 2015, Acquaviva et al. (2015) presented a method, Energy Signature Analysis (ESA), to collect, store and process large amounts of data (so-called Big Data) in order to monitor energy efficiency. The method (1) investigates the efficiency of the heating system by comparing heating power with previously observed power at the same state, which may for example be at the same outdoor temperature, and (2) ranks the building compared to similar and nearby buildings with respect to energy performance.

In Hitchin (2017), the current ISO standard for energy performance in buildings is reviewed. The standard is used in the EU Building Directive for both new constructions and existing buildings. Hitchin (2017) also compares calculated

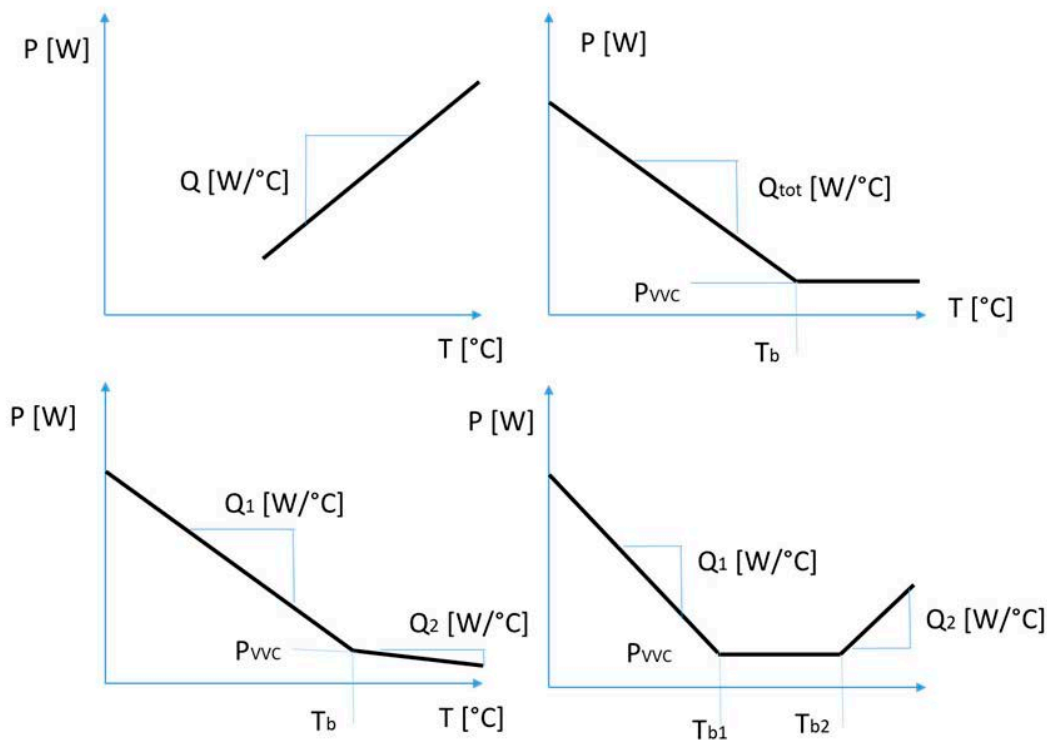

Figure 1. Illustration of change-point models with two to five parameters.

energy use based on a change-point model with the ISO-standard calculation and shows that the accuracy for total energy use is good but that the change-point model provides more information, including the building's balance temperature, and is therefore preferred. The standard calculation generally under-predicts energy use and has larger variations.

In Vesterberg et al. (2014), a first step in using a change-point model as a calibration tool to increase the accuracy of building performance simulation programs (BES) is investigated. A linear regression model is used to generate the specific heat loss and heat loss to the ground for two multi-storey houses in Umeå, in the northern part of Sweden, which are connected to the district heating network. The model is based on district heating data and electricity consumption for two years.

2.2 BUILDING ENERGY USE AND THE APPLIED CHANGE-POINT MODEL

Based on the second model, with three breakpoints, as described in Figure 1, two key factors can be quantified. The factors are: (1) the heat demand for hot water circulation and hot water use, and (2) the total loss term for the building, Q_{tot} ($W/°C$). The quantified parameters are illustrated in Figure 2.

The consequences of being able to calculate Q_{tot} are important, as Q_{tot} is an indicator of the building performance. Q_{tot} is the sum of the transmission losses through walls, windows and roofs, cold bridges, infiltration and ventilation. That is, all the losses for the building. This means that this is a much better indicator of a

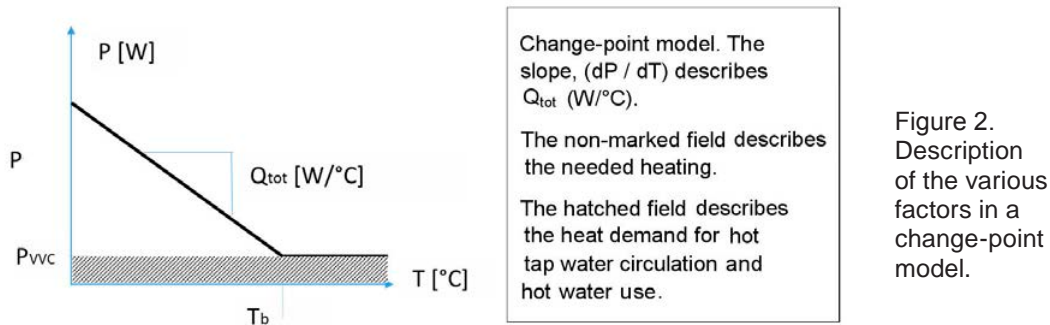

Figure 2. Description of the various factors in a change-point model.

building's energy performance than knowing the specific energy use in kWh/m² per year. Based on Q_{tot} , information about the technical performance of the building is obtained. The energy use of a building can be formulated as in Equation 1:

$$E = Q_{tot} \cdot DH = (\sum(U \cdot A) + \sum(\psi \cdot l) + (1 - \sigma)\dot{v}_v \rho c_p + \dot{v}_{inf} \rho c_p) \cdot G_t \quad (1)$$

where E is the energy use (Wh), Q_{tot} the total loss term (W/°C), DH the degree hours (°Ch), $\sum(UA)$ the thermal performance of the envelope (W/°C), cold bridges (W/°C), ventilation (W/°C) and infiltration (W/°C). The degree-hours method is based on the local climatic conditions, e.g. average temperature at the location, and the balance temperature of the building. The balance temperature describes the fictive temperature that the heating system needs to heat up to (Abel and Elmroth, 2007). As a result, the loss term describes the sum of the loss terms for ventilation, cold bridges, infiltration and ventilation, which provides a good basis for assessing the efficiency potential together with a techno-economic optimization such as OPERA-MILP¹. At aggregated levels, such as district level, we can describe categories of buildings and packages of conservation measures. The matlab code used in this paper, presented in Wahlqvist (2017), is based on a three-point change-point model.

3. CASE STUDY – THE STUDIED BUILDINGS

Vasastaden is a central district in Linköping, Sweden, with the geographic co-ordinates latitude 58.42 and longitude 15.61. The district consists mostly of multi-family buildings built before 1960, connected to the district heating network. Six multi-family buildings, denoted A-F, located in Vasastaden, were selected as study objects in this investigation. The buildings were constructed between 1908 and 1936. Two of the buildings are detached, two are semi-detached and two are terraced. None of the buildings have comfort cooling. Construction data about the buildings are summarized in Table 1. In addition, data from the national energy performance register, Gripen, are presented in terms of estimated heating demand, excluding domestic hot water use. Data from Gripen are weather corrected to consider climate variations from year to year. The presented figures

1) The LCC optimization software OPERA-MILP (Optimal Energy Retrofits Advisory-Mixed Integer Linear Program) is used in order to find the cost-optimal energy renovation strategy for a building during its whole life cycle. A more detailed description of the method is found in Liu et al. (2016).

in Table 1 are based on a weather correction using an energy index where differences in outdoor temperature are considered, as well as the impact from the sun, wind, etc.

Table 1. Information and properties for the studied buildings

Construction data/ Building	Information					
	A	B	C	D	E	F
Detached					x	x
Semi-detached		x				
Terraced	x		x			
Construction year	1929	1931	1936	1929	1929	1908
No. of stories	3	4	5	5	5	4
No. of apartments	18	13	49	11	20	5
Heated area (m ²)	1088	845	4195	1941	2850	1241
Window type	3-pane	2-pane and 3-pane	3-pane	2-pane	2-pane	2-pane
Percentage share windows of total façade area	15.5	30	34.5	14	16	16
$E_{e,i}$ (kWh/m ²)	107.9	161.7	102.8	115.9	120.2	150.9

The exterior of the buildings (A-F) is illustrated in Figures 3 (a–f).

In this investigation, hourly energy use is used for all buildings during the time period June 2016 – May 2017. District heating data are obtained from the regional energy company Tekniska Verken AB. Outdoor temperature data are obtained from the Swedish Meteorological and Hydrological Institute. The weather station



Figure 3 (a-f). The six buildings included in the study. All buildings were built before 1945. Photos: Vlatko Milic.

used is located in Malmslätt, approximately 6 km west of the study objects. The mean annual outdoor temperature during the time period is 8.0 °C. The studied objects are described in more detail in Wahlqvist (2017).

4. RESULTS

The results for the six historic buildings built before 1945 (A-F) are presented in Figures 4-9. The left figure for each building represents the hourly values of power (W/m^2) as a function of time, the middle figure represents the results from

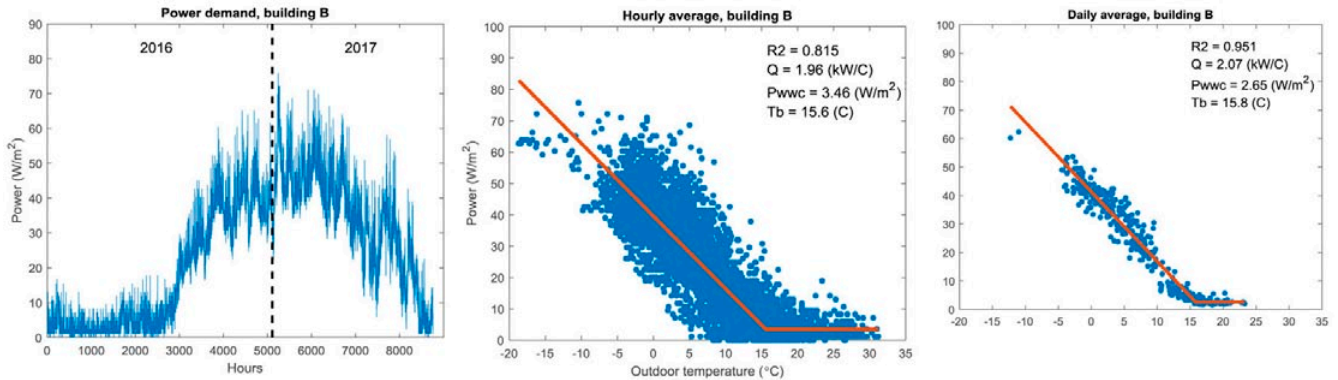

Figure 4. Building A, measured hourly values of power (left), results of hourly change-point model (middle) and daily change-point model (right).

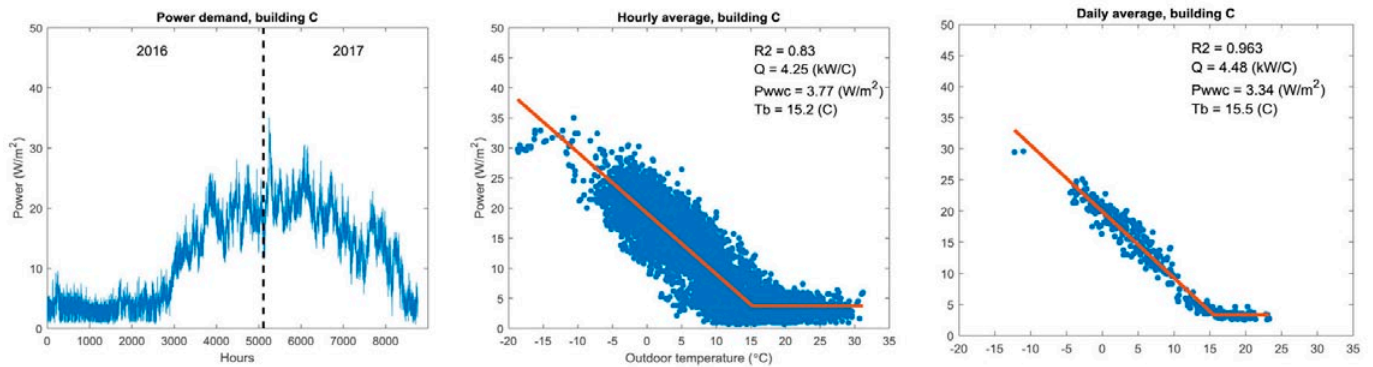

Figure 5. Building B, measured hourly values of power (left), results of hourly change-point model (middle) and daily change-point model (right).

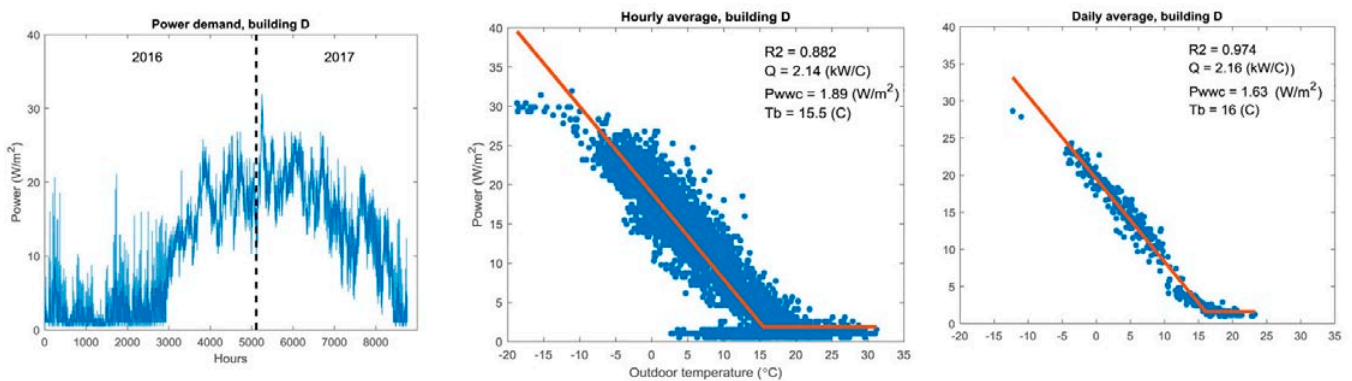

Figure 6. Building C, measured hourly values of power (left), results of hourly change-point model (middle) and daily change-point model (right).

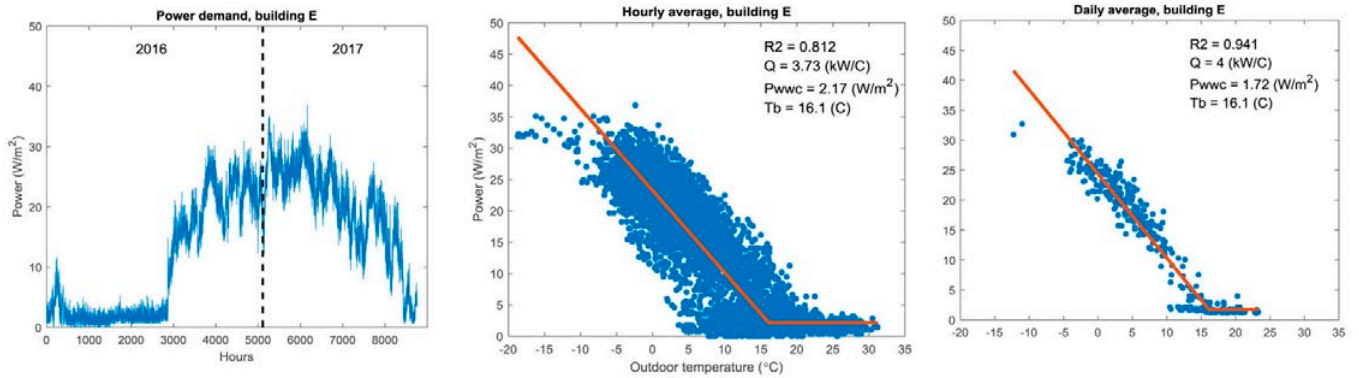

Figure 7. Building D, measured hourly values of power (left), results of hourly change-point model (middle) and daily change-point model (right).

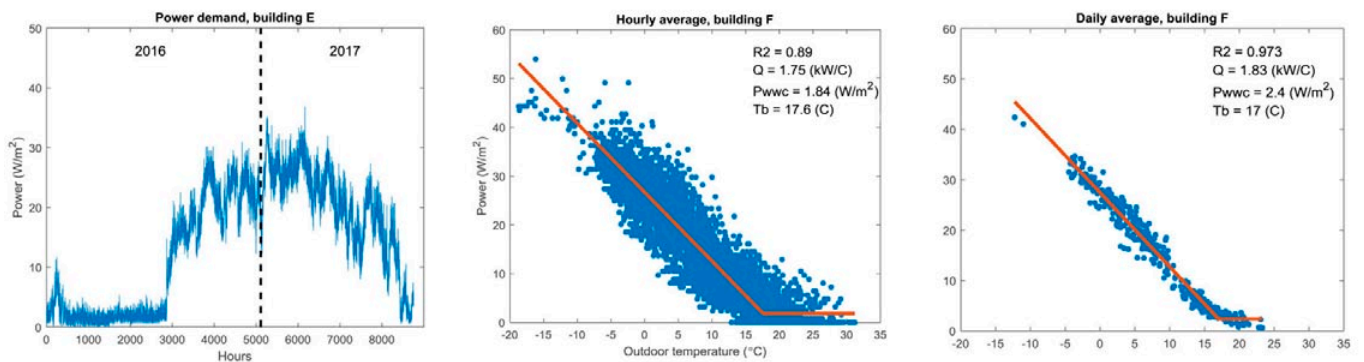

Figure 8. Building E, measured hourly values of power (left), results of hourly change-point model (middle) and daily change-point model (right).

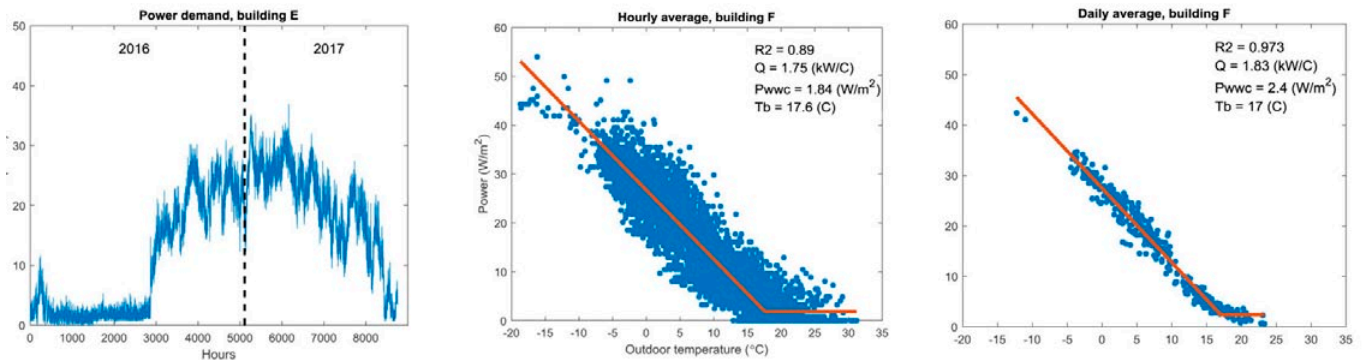

Figure 9. Building F, measured hourly values of power (left), results of hourly change-point model (middle) and daily change-point model (right).

a three-point change-point model with hourly resolution, and the right figure represents the results for a three-point change-point model with a daily average.

The difference in Q_{tot} as a result of changing from hourly to daily averages of power is on average 4.4 %, and Q_{tot} ranged from 1.6 kW/°C to 4.3 kW/°C in the buildings. The maximum deviation is 7.2 %. The deviation for the balance

temperature is on average 0.3 °C. For the characteristic describing the hot water circulation and hot water use P_{wvc} , the average difference is about 20 %. In terms of R2 values for the buildings, the fit is about 80 % for the hourly values and over 90 % for the daily averages.

5. CONCLUDING DISCUSSION

The use of a change-point model to describe the energy performance of buildings in general, and the historic buildings in this study in particular, is shown to be effective. This is because it provides additional information compared to e.g. the specific energy use in kWh/m² (A-temp) reported in the database for the national energy audit program. The main contributions are the building's total loss term, Q_{tot} , as well as balance temperature, and heat for hot tap water circulation and hot water use. In addition, another advantage of using a change-point methodology is that it is possible to study the effects of renovations, e.g. how the total loss term, Q_{tot} , and balance temperature (T_b), are affected before and after renovation.

The amount of data needed to perform this analysis, or to follow large groups of buildings, is not considered to be high or hard to get access to. Presently, the information is collected by the energy supplier, and can easily be ordered by the owner of a building. If continuously collecting data from a building, it is also possible to follow the development of a building and how it changes.

Another argument for using this type of method is that the variations due to the fact that different occupants behave differently when it comes to their use of energy in the building can, to a high degree, be filtered out with this method. Hence, it is possible to design effective packages of measures based on the technical performance of the buildings, not only on how they are used by the current tenants. The information can also, if collected when audits are made, be used to support decisions for housing companies, and also provide valuable input for the national renovation strategy. From a housing company perspective, this is also an easy way to find malfunctions, such as control problems, etc., and can be used to get an overview of the building stock.

6. ACKNOWLEDGEMENTS

The authors of this paper would like to thank Tekniska Verken AB and Lina Hallberg at Stångåstaden for their valuable help with data collection. The authors would also like to thank the Swedish Energy Agency for financial support from the Spara och bevara programme.

7. REFERENCES

- [1] Abel E., Elmroth, A., 2007: Buildings and Energy – a systematic approach, Formas.
- [2] Acquaviva A. et al., 2015: Energy signature analysis: knowledge at your fingertips. IEEE International Congress on Big Data.
- [3] ASHRAE, 2002: ASHRAE GUIDELINE- Measurement of Energy and Demand Savings. 140–143.

- [4] Claridge D., Haberl J., Sparks R., Lopez R. & Kissock K., 1992: Monitored Commercial Building Energy Data: Reporting the Results. *ASHRAE Transactions: Symposia* 881–889.
- [5] Hammarsten, S., 1987: A Critical Appraisal of Energy-Signature Models. *Applied Energy* 26: 97-110.
- [6] Hitchin R., 2017: Monthly utilization factors for building energy calculations. *Building Services Engineering Research & Technology* 38: 318–326.
- [7] Vesterberg J., Andersson S. & Olofsson T., 2014: Robustness of a regression approach, aimed for calibration of whole building energy simulation tools. *Energy and Buildings* 81: 430–434.
- [8] Wahlqvist M., 2017: Modellering av energianvändning i flerbostadshus. En studie över möjligheter och begränsningar med olika sätt att beräkna energisignatur, examensarbete UU (in Swedish).
- [9] Liu L., Rohdin P., Moshfegh B., 2016: LCC assessments and environmental impacts on the energy renovation of a multi-family building from the 1890s. *Energy and Buildings* 133: 823–833.

Theory and practice, a longitudinal study on developing an energy solution for the Der Aa-church

M. Vieveen

Research centre for Built Environment NoorderRuimte, Hanze University of Applied Sciences, (HUAS), Groningen, The Netherlands. Email: m.c.vieveen@pl.hanze.nl

Abstract – How do actors develop energy solutions for historical buildings? The literature addresses various principles, approaches and instruments to explain how energy solutions could be developed and why conflicts might emerge during decision-making processes. This paper outlines how heritage principles structure heritage approaches and consequently the development of an energy solution. This conceptual framework is illustrated and tested with a longitudinal case study of the Der Aa-church in Groningen (the Netherlands). The results show that the conceptual framework is a useful tool for data-collection, analysis and explanation of the development of energy solutions. Furthermore, the empirical data suggest divergences from the theory. For example, it nuances the characteristics of heritage principles and heritage approaches. Moreover, the findings suggest that decision-making processes evolve rather chaotically and propulsively, instead of hierarchically and gradually.

Keywords – conceptual framework; heritage; energy efficiency; case study; the Der Aa-church

1. INTRODUCTION

The energy transition, which strives towards energy reduction and the use of renewable energy [1], is having a major impact on our thinking about producing and consuming energy and will affect the appearance of the built environment including built heritage. Because built heritage is the product of how our society developed and reflects cultural identity [2], applying energy interventions might become a threat for preservation and may cause tensions in decision-making processes [3]-[7]. The objective of this paper is to improve our understanding about how energy solutions for historical buildings are developed in practice. In the literature, a wide variety of research focuses on how to handle contemporary issues in historical assets. This section elaborates on the conceptual framework of Network Erfgoed and Ruimte [6], which distinguishes three levels of abstraction in decision-making – the why, how and what – to explain how heritage principles structure developing solutions for historical assets.

Firstly, the fundamental level is concerned with the why; it focuses on principles (or discourses) that structure decision-making processes [6]. Several authors classified co-existing fundamental principles in terms of heritage paradigms [3] and heritage approaches [4]-[7]. Despite differences in terms and nuances in descriptions, I have distinguished three heritage principles which have their own justification and actor perspective (table 1): a *preservation principle* that strives

towards keeping heritage as it is or was meant to be from an expert perspective in a specific domain, a *conservation principle* that strives towards improving the current situation from multiple perspectives and domains and a *heritage principle* that strives towards passing through the message of heritage from a user perspective.

Secondly, the strategic level is concerned with the how; it focuses on methodologies (or procedures) and methods. According to the literature [4]-[6] heritage principles structure the choices at the strategic level by determining the project's conditions and subsequently the project's methodology. De Roo [8] uses a comparable classification to categorise the level of complexity of a decision-making process. The themes and types of the strategic level are added to table 1: a *sector approach* where decision-making processes are categorised as simple since the actors with equal principles define the project's conditions; a *factor approach* where decision-making processes are categorised as complex since the actors with multiple principles need to reach consensus about the project's conditions, and; a *vector approach* where decision-making processes are categorised as very complex since the actors—with multiple principles—might change during the process which may lead to redefining the project's conditions.

Thirdly, the operational level is concerned with the what; it is about instruments and problem solving. No distinction is made for heritage principles or approaches because solutions are tailor made. According to Van Dooren et al. [9] two main themes influence progress in decision-making: 1) iteration by weighting various decision-making criteria (ranging from technical aspects towards context-related social aspects), and; 2) phases of diverging and converging to improve the problem definition and gradually develop an end result.

Table 1. An overview of themes and types per level of abstraction

Level of abstraction	Themes	Types		
Fundamental level (why)	<i>Perspective</i>	Sectoral (experts)	Facetted (experts)	Context (owners, users)
	<i>Justification</i>	Keep	Adapt	Use
	<i>Heritage principle</i>	Preservation	Conservation	Heritage
Strategic level (how)	<i>Composition actors</i>	Fixed	Fluid	Plural
	<i>Project conditions</i>	Singular and fixed	< intermediate >	Multiple and plural
	<i>Level of complexity in decision-making</i>	Simple	Complex	Very complex
	<i>Outcome</i>	Fixed	Fluid	Unpredictable
	<i>Heritage approach</i>	Sector	Factor	Vector
Operational level (what)	<i>Progress in decision-making</i>	By iteration between various decision-making criteria		
		By diverging and converging phases		

2. RESEARCH METHODOLOGY

The conceptual framework relies on different theoretical perspectives (heritage, planning and design theory); it provides a wide variety of topics to improve our understanding about how energy solutions for historical assets are developed

in practice. This section first describes the use of the conceptual framework for data-collection and analysis, and secondly, introduces the case study project.

A wide variety of data is acquired from the case study by using multiple methods [10] such as participatory observation, desk research and in-depth interviews the latter between July 2017 and January 2018. Only actors with a prominent role were approached for an in-depth interview; table 2 provides an overview of the key actors per period. Data-collection is described in more detail in the case study introduction. The data were analysed with the help of the software package Atlas.ti 8.0 [11]. The fundamental level focuses on the actor-perspective; this involved investigating heritage principles held by key actors regarding heritage, sustainable development and how to combine heritage preservation and the energy transition. At the strategic level, data-collection involved an inventory of developments in A) the composition and roles of actors, and B) the type of projects conditions. The operational level focuses on how the content of decision-making evolved, for example decision-making criteria and results. Furthermore, key actors were asked to address impact factors to provide insight in what influenced progress in decision-making.

The Der Aa-church in Groningen (Figure 1) was selected as a case study because, as a longitudinal project, it provides a considerable amount of data about developing an energy solution. Data were easy to access; the key actors were eager to collaborate in providing the data and allowed me to participate in the decision-making process. Before the results are presented (section 3–5), a background of the decision-making process is described per period.



Figure 1. Photo impression the Der Aa-church in Groningen. Photos by the author.

The Der Aa-church is a large Gothic church, in the city centre of Groningen in the Netherlands, which was listed for its national importance in 1971. The first period includes a comprehensive restoration project in the 1970–1980s. Data on this period were collected by accessing restoration logs and interviewing key actors.

Urgency for change became evident in the second period, between 1990 and 2011. An adaptive reuse project resulted in the present-day use for commercial and cultural events, such as diners, concerts, exhibitions and fairs. Furthermore, facilities were added to improve daily use, such as a reception room (vestibule), a heating system, a kitchen, an elevator and utility rooms. As a result of intensified use in the 1990s, complaints increased about energy costs and thermal comfort. In the late 1990s, the restoration of the monumental Schnitger organ resulted

in an increasing awareness for the relationship between the indoor climate and damage to historical material. Data on this period were collected by interviewing key actors.

The third period, between 2011 and 2013, focused on understanding the current situation and exploring potential energy interventions. The owner submitted its building as a case study in a research project about improving the energy efficiency of historical buildings, which I guided. Data on this period were collected by participatory observation, which included guiding research by a project team with experts from different fields; by desk research such as reports, minutes, email correspondence and; interviewing key actors.

The fourth period covers 2015 and started when the daily operator was approached for an ambitious exhibition that required darkening the church. After in-depth window research, the owner participated in a prize contest to win free energy consultancy. Data on this period were collected by conducting research on window interventions; by desk research such as reports, minutes, email correspondence and; by interviewing key actors.

The fifth period started after winning the prize contest in 2016; actors with various backgrounds were invited to participate in a project team with the aim to develop an energy solution for the Der Aa-church. Data on this period were collected by participatory observation such as participating in project meetings; by desk research such as reports, minutes, email correspondence and; by interviewing key actors.

Table 2. Key actors per period. X = participated; (X) = participated partially; * = interviewed

Period	1	2	3	4	5
Owner*	X	X		X	X
Building Engineer 1*	X	X	X		
Restoration architect*	X	X	X		
Daily operator		X	X	X	X
Municipality, heritage 1*		X			X
Researcher			X	X	(X)
Municipality, heritage 2*			X		(X)
Municipality, heritage 3					(X)
Building Engineer 2*					X
Energy consultant*					(X)
Municipality, energy*					X

3. THE FUNDAMENTAL LEVEL: VIEWS OF ACTORS

The key actors explained that views are linked to individuals and that they are not fixed; they can evolve by knowledge and experience. Furthermore, they explained that when actors collaborate, and exchange views, knowledge and experience, mutual respect is created, and subsequently collective heritage principles develop. Creating a collective heritage principle may be a hard process. For

example, a conflict between individual heritage principles (fifth period) delayed decision-making. Afterwards, several key actors stated that this may have slowed down progress, but that it contributed in strengthening the collective heritage principle.

Table 3 provides an overview of the characteristics that constituted the collective heritage principle. Identifying the collective heritage principles was challenging because the characteristics in practice do not strictly follow those of the conceptual model. For example, instead of a single actor perspective, both the owner, user and experts were decision-makers. A collective preservation principle was identified for the first and second period due to the focus on heritage protection, and a collective conservation principle for the third, fourth and fifth period due to the focus on improving daily operation.

Table 3. Characteristics of heritage principles at the fundamental level per period

Period	1	2	3	4	5
<i>Perspective</i>	Experts, owner, user	Experts, owner, user	Experts, owner, user	Experts, owner, user	Experts, owner, user
<i>Justification</i>	Keep	Adapt	Adapt	Adapt	Adapt
<i>Topic energy efficiency</i>	Not present	Heating system applied	Energy efficiency, thermal comfort	Darkening, thermal comfort, energy efficiency	Energy efficiency thermal comfort
<i>Collective heritage principle</i>	Preservation	Preservation	Conservation	Conservation	Conservation

4. THE STRATEGIC LEVEL: APPROACHING DECISION-MAKING

To manage the decision-making process, the owners emphasized the importance of using different management approaches to shift between exploratory and in-depth phases. The project managers used different management approaches for decision-making, which influenced the project's conditions and the composition of actors involved. Furthermore, the owner addressed the importance of intermediate phases between decision-making periods, because it allows decision-makers to evaluate results or to generate support. For example, in a project-oriented approach, the project manager used tenders to define fixed project conditions and to guide a limited number of actors to conduct research. Alternatively, in a result-oriented approach, the project manager invited actors with various backgrounds (a project team) to further define the projects' conditions, to conduct research and to discuss preliminary results during project meetings. This indicates that the heritage principles held by the project manager structure choices on the strategic level.

Table 4 provides an overview of the characteristics that constituted the heritage approach. Uncovering the heritage approach was also challenging, because the characteristics in practice diverge from the conceptual model. For example, in the third and fifth period, the management approach widened the projects conditions and subsequently made the outcome less predictable. A sector approach

was identified for the first and second period, and a factor approach for the third, fourth and fifth period. Remarkably, the heritage approaches seem to be related to the collective heritage principles, because the former paragraph indicates that the heritage approach is mainly influenced by the individual heritage principle of the project manager.

Table 4. Characteristics of heritage approaches at the strategic level per period

Period	1	2	3	4	5
<i>Project management</i>	Owner	Owner	Researcher	Owner	Owner
<i>Management approach</i>	Project-oriented	Project-oriented	Result-oriented	Project-oriented	Result-oriented
<i>Composition actors</i>	Limited number of fixed actors	Limited number of fixed actors	A fluid project team with multiple expertise	Limited number of fixed actors	A fluid project team with multiple expertise
<i>Project conditions</i>	Singular and fixed	Singular and fixed	Multiple and plural	Multiple and fixed	Multiple and plural
<i>Level of complexity in decision-making</i>	Simple	Simple	Complex	Simple	Complex
<i>Outcome</i>	Fixed	Fixed	Unpredictable	Fixed	Unpredictable
<i>Heritage approach</i>	Sector	Sector	Factor	Factor	Factor

5. THE OPERATIONAL LEVEL: DEVELOPING AN ENERGY SOLUTION

According to the key actors, developing an energy solution was influenced by, firstly, internal developments such as researching, designing and discussing, and secondly, the result of external developments.

Table 5 provides an overview of the content of decision making, illustrating iteration and divergence and convergence throughout the periods. For example, after restoring the Der Aa-church (end of first period), a project was initiated for adaptive reuse and related facilities were added, such as a heating system. The intensified use resulted in complaints about experienced low temperatures, cold draft and energy costs (second period). As a result, interventions were explored that should improve thermal comfort and energy efficiency (third period). The owner and daily operator initiated a follow-up in-depth window study after they had been approached by a potential client for an ambitious exposition that required darkening the church. The results of the third and fourth period were critically assessed (fifth period), which led to a recalibration of the assumptions of the current energy use and subsequently in recalibrating the long-list. The project team concluded that further decision-making requires a users' vision for the upcoming 10–15 years.

Findings suggest that the individual heritage principles of the project manager structure choices on the strategic level. However, the collective heritage approach strongly influences decision-making on the operational level: the actors involved influence decision-making by conducting research, developing the energy plan and discussing preliminary results. Empirical findings differ from the conceptual framework, implying that by diverging and converging phases, the end result

Table 5. Content of decision-making at the operational level per period

Period	1	2	3	4	5
<i>Spatial scale</i>	Building	Building	Building and surrounding area	Building element (windows)	Building
<i>Project goal</i>	Restoring the Der Aa-church	Improving utility value without damaging heritage values	Reducing energy costs, improving thermal comfort, not damage heritage values	Darkening, improving thermal comfort, reducing energy costs, limit damage to heritage values	Improving thermal comfort, not increasing energy costs, no natural gas, limit damage to heritage values
<i>Decision-making criteria</i>	Structural safety, heritage values	Heritage values, daily operation, thermal comfort.	Heritage values, energy use, thermal comfort, life cycle costs	Heritage values, darkening, thermal comfort, energy use, life cycle costs	Heritage values, thermal comfort, life cycle costs, energy use
<i>Results</i>	Church restored	Adaptive reuse (new facilities such as a heating system)	An long-list with potential energy interventions	Potential window interventions were extended in more detail	Recalibrating current energy use and the long-list
<i>Conclusions</i>	How to improve daily use?	User complaints about thermal comfort and energy costs	Two energy interventions for in-depth research	Building scope required for long-term solution	Further progress requires a users' vision (upcoming 10-15 years)

would gradually develop. Table 6 provides an overview of impact factors that increased or slowed down progress, and may also have resulted in recalibrating the collective heritage principle and the projects conditions.

Two main factors had a major influence on progress in decision-making: external funding and the project managers' capacity to cope with unexpected developments. Budget to cover the operating expenses of the Der Aa-church is generated by renting income, maintenance subsidies and external financial support. Therefore, external funding has a major influence on progress in decision-making. The owner aims to develop convincing plans that are substantiated with a vision and research, because this encourages the enthusiasm of sponsors. Therefore, they emphasize ambitious project conditions, and keep financial decision-making criteria vague. The owner stated that, after all, 'plans can always be economized or phased'. Developing an energy solution for the Der Aa-church is a longitudinal process; several key actors stated that they are not surprised when a project with this complexity covers 10–14 years. They argue that this is due to the dependency on external funding and the need to develop a well-made plan, which requires actors with a wide variety of expertise for weighting the various decision-making criteria. Key actors stress the importance of the project managers' ability to motivate actors; which also implies that the project manager should be able to involve or to retain actors at the right moment. The owner emphasised the ability to act strategically and to cope with unexpected developments. Furthermore, the owner added that you cannot always manage a project, and that you need some luck in coping with unexpected developments.

Table 6. Impact factors that propulsive influenced progress in decision-making per period

Period	1	2	3	4	5
<i>Funding</i>	Funding church restoration; blocked to enforce the replacement of actors	Funding adaptive reuse and organ restoration	Free input on energy efficiency		Free energy consultancy
<i>Government policy</i>		On adaptive reuse and property taxes			On sustainable heritage. Revitalizing the public space near the church
<i>Daily operation</i>				Request for an exhibition that required darkening	
<i>Network</i>		Transference of the gravestones allowed applying floor convectors	Suggestion to participate in a research project	Winning a prize contest for energy consultancy	
<i>Teams composition</i>		A mediator settled differences among actors			Replacement of an actor; temporarily non-participation of an actor

6. DISCUSSION

The objective of this paper is to improve our understanding of how energy solutions for historical buildings are developed in practice. The paper illustrates that the conceptual framework is a useful tool for data-collection and analysis. The underlying theories provided a wide variety of topics to collect data from multiple sources with multiple research methods. Regarding data-analysis, the conceptual framework enables distinguishing and connecting different aspects which improved the ability to explain how an energy solution for the Der Aa-church was developed. Furthermore, the framework enabled investigating what impact factors affect progress and stagnation of a decision-making process. Remarkably, for the Der Aa-church, the propulsive development of the energy solution might be enhanced because of the dependence of external funding to continue the decision-making process.

Finally, the empirical results also indicate differences that lead to questions about the underlying theories, such as the fluid character of heritage principles, the less stringent characterisation of the heritage principles and approaches, the lack of clarity about what principle structures the approach, the propulsive influence of unexpected developments that may affect all levels of abstraction, and the rather chaotic mutual relation (in contrast of the hierarchal relation) of the levels of abstraction in decision-making.

Conclusions in this paper are based on a single case study, on an object level (building), where heritage preservation was a dominant decision-making criterion.

Further research is recommended to be able to generalise the findings of this paper and to improve the conceptual framework. Regarding the latter, the generic character of the conceptual framework may also allow conducting research on a decision-making process that concerns other spatial scales such as local level (area) or regional level (landscape), where actors might have different strategic positions and where more subprojects might be developed simultaneously.

7. ACKNOWLEDGEMENTS

H. Renes, J. Janssen, M. Oostra and T. van der Schoor for their feedback.

8. REFERENCES

- [1] U. G. Assembly, "A life of dignity for all: Accelerating progress towards the millennium development goals and advancing the united nations development agenda beyond 2015," 2013.
- [2] G. J. Ashworth, B. J. Graham and J. E. Tunbridge, *Pluralising Pasts: Heritage, Identity and Place in Multicultural Societies*. Pluto Pr, 2007.
- [3] G. Ashworth, "Preservation, conservation and heritage: Approaches to the past in the present through the built environment," *Asian Anthropology*, vol. 10, (1), pp. 1–18, 2011.
- [4] J. Janssen et al, "Heritage as sector, factor and vector: conceptualizing the shifting relationship between heritage management and spatial planning," *European Planning Studies*, vol. 25, (9), pp. 1654–1672, 2017.
- [5] J. Janssen et al, "Heritage planning and spatial development in the Netherlands: changing policies and perspectives," *International Journal of Heritage Studies*, vol. 20, (1), pp. 1, 2014.
- [6] H. Renes et al, "Character sketches; national heritage and spatial development research agenda; part 1 research agenda," *Netwerk Erfgoed & Ruimte*, 2014.
- [7] J. Pendlebury, "Conservation values, the authorised heritage discourse and the conservation-planning assemblage," *International Journal of Heritage Studies*, vol. 19, (7), pp. 709-727, 2013.
- [8] G. de Roo, *Planning Per Se, Planning Per Saldo: Over Conflicten, Complexiteit En Besluitvorming in De Milieuplanning*. Sdu Uitgevers, 1999.
- [9] E. van Dooren et al, "Making explicit in design education: generic elements in the design process," *International Journal of Technology and Design Education*, vol. 24, (1), pp. 53-71, 2014.
- [10] R. Yin, *Case Study Research: Design and Methods*. Sage publications, 2014.
- [11] M. Hennink, I. Hutter and A. Bailey, *Qualitative Research Methods*. Sage, 2010.

Heritage values as a driver or obstacle for energy efficiency in Victorian and Edwardian buildings

D. Newton and K. Fouseki

Institute for Sustainable Heritage, Bartlett School of Environment, Energy and Resources, University College London (UCL), London, UK.

Abstract – This paper explores how homeowners living in Victorian and Edwardian homes within conservation areas in Cambridge balance aesthetic and heritage values against lower energy costs and improved comfort levels. Previous government initiatives aimed at saving energy and reducing CO² have drawn little interest from this group who are left to work through their own solutions. Through semi-structured interviews with homeowners, we examine the stages of energy efficient retro-fitting and the impact of their retro-fitting decisions on the heritage values and energy performance of their residence. A sample of retro-fit measures are checked by thermal imaging (in heatwave conditions) with no obvious problems being detected although further testing is recommended. It clearly becomes apparent that simple measures such as draught stripping and increased loft insulation with quality products are being overlooked. The designation of the conservation areas is also considered. Areas improve as road closures, parking restrictions and traffic calming reduces traffic volumes in the neighbourhood, but with this more onerous planning restrictions also follow, which may restrict those with aspirations to extend their homes.

Keywords – energy efficiency; heritage values; conservation areas; Cambridge; thermal comfort; residents

1. INTRODUCTION

There is limited research which seeks to understand how homeowners of Victorian and Edwardian buildings balance energy efficiency, keeping their homes warm and consideration of their own perceptions of the heritage values contained within their dwelling. Only recently, there has been some research [1] [2] [3], placing the homeowner or user of the building at the centre of the discussion where the issues of energy efficiency, maintaining a warm home and the buildings values are to be considered. This is important because dwellings built before 1919 represent one fifth of the total of 26 million dwellings in the UK [4] and this type of property is categorised as ‘hard to treat’ by the Building Research Establishment. Furthermore, schemes such as the Green Deal which the government launched to help homeowners insulate the outsides of homes offer very little to those within this group. Homeowners are therefore left to work through their own decisions and solutions.

It is the aim of this paper to examine the degree to which ‘*heritage values*’ associated with Victorian and Edwardian dwellings drive or prohibit energy efficiency? The paper will do so by thematically analyzing 18 semi-structured interviews with homeowners of Victorian and Edwardian homes within conser-

vation areas in Cambridge who have undertaken varying degrees of retro-fitting to their homes. Thermal imaging has also been carried out on a sample of the group as a first step analysis investigating retro-fitted windows, doors and under-floor insulation; this therefore adds a quantitative element to the study.

2. METHODOLOGY

Our methodological approach is socio-technical. We have collected and analysed qualitative, social data regarding perceptions and attitudes of homeowners of traditional buildings in conjunction with scientific, thermal imaging data related to the performance of the building. Homeowners were recruited via 'snowballing' – that is via networks and personal contacts who could introduce the researchers to further participants. This is vital because there are certain health and safety issues when visiting residences of people who are unknown to the researchers. In addition, snowballing guarantees participation because it is based on trust. All interviews were transcribed and thematically coded resulting initially in 70 and then collapsed to 15 overarching themes including original features; physical conditions of original features; dissatisfaction; satisfaction; cultural/heritage values; interior insulation; personal interest in conservation; space; replication; cost of restoration compared with replacement; mortgage requirements; prior experience living with original features. Limited thermal imaging was carried out on a sample of the dwellings to test the effectiveness of retrofit measures that have been undertaken, and some preliminary findings are presented in the form of thermographic images. A Fluke thermal imaging camera (model No. TiR 105) was used on a sample of the homes within the study. The camera was used indoors where there was a much higher temperature outside. The objective was to identify any leakages of air from windows, doors or timber suspended floors particularly where retrofit measures have been undertaken. The use of thermal imaging cameras during heatwaves has been investigated by Cambridge Carbon Footprint, a charity who offer support to people around Cambridge with energy saving initiatives and have subsequently produced a guide on the subject. The exercise is intended to produce a first step analysis of the efficiency of retrofit measures. We acknowledge that the thermal imaging is limited but still provides a first snap-shot of the possible effects of certain interventions on the thermal and energy performance of the building. We thus use it as an illustration and also as a prompt to foster future similar studies that merge together qualitative data related to perceptions and values with more technical data related to the actual performance of the building. The collected data were mapped and analysed via system dynamics, a method used for mapping and modelling the dynamic interrelationships of variables shaping and affecting a phenomenon, system, behaviour, etc. [5] [6] as a method to map the dynamic interactions between heritage values and energy efficiency interventions. The coded information was presented via Vensim software in order to produce a causal map diagram (Figure 3).

3. FINDINGS

3.1 BALANCING HERITAGE VALUES AND ENERGY RETRO-FITTING

Many of the interviewees have come to Cambridge to live and work, they have bought houses and settled in the city, many have then moved again often within close proximity to their former home. In view of this, we could state that the participants are favourably pro heritage. However, even so, this group of respondents is of interest because their responses can be juxtaposed to other groups of interviewees who do not hold a special interest in heritage (see Fouseki and Bobrova in this volume and Koukou and Fouseki in this volume). The age group of the interviewees is between thirty and seventy years of age. 13 out of 18 interviewees have lived in Cambridge for 22 years or more, with 6 having been in their current property for over 29 years contributing to a high sense of area attachment as the following quote indicates [7]. As one of the interviewees pointed out “*We love the houses, we love the neighbourhood, it’s a real community, we don’t want to leave*” (Interviewee 1: Female, 30–35, Professional). They also assigned high heritage and aesthetic values. Almost all of the homeowners interviewed undertook some form of ‘stock check’ when they bought their homes, making an early assessment of what original features they had and what condition they were in. Houses ranged from virtually untouched with most original features remaining to those with very few or features that were damaged or in a state of decay. Whether the house had been bought 38 years ago or more recently there was always a strong recollection of the features homeowners had started out with. Indeed, almost all homeowners indicated that it was important to preserve the original features that they had ‘inherited’, but other values not just aesthetic were found to be important:

‘I think people who want these sorts of houses want them with as many period features as they can have’. ‘I love the high ceilings and the big windows, the big garden I like, it’s got an expansive hallway with stairs leading up, I quite like things like the cornicing and the roses, things like that’. (Interviewee 1: Female, 30–35, Professional).

Other aspects of the house that homeowners considered important were; its location, the spatial qualities of the house; its amenity value; the amount of light or its orientation to the sun, along with walled gardens. Features that homeowners most commonly thought important and worth preserving were the sash window, fireplaces, cornicing, roses and other plasterwork, stained glass, original glass, staircases and skirtings:

‘I am quite passionate about preserving the old glass, if you lose that, you lose the beautiful ripply effect that you get with old glass.’ (Interviewee 16: Male, Photographer, 60–65)

3.2 BALANCING RETRO-FITTING WITH SPACE

Around half of the homeowners interviewed had undertaken a programme of modernisation on buying their homes. This typically included upgrading of the services for example, re-wiring, plumbing, replacement heating, new kitchens and bathrooms along with other works such as rectifying failed damp proof courses,

making good ceilings and plaster surfaces. Many homes had been purchased with rear extensions constructed; few homes had many retro-fit measures installed.

The interviews suggest that space planning is an important consideration even in the larger more prestigious 3 storey semi-detached Victorian and Edwardian homes, this may be that the cellular room layouts do not meet the requirements for modern family living. The smaller 2 storey terraced houses are generally considered to be too small in their original layout.

Of the 18 Victorian and Edwardian homeowners interviewed, 14 houses had extensions. Retrofitting is generally undertaken by homeowners incrementally. In two instances retrofitting, renovation and modernisation was undertaken at outset, the major construction works lasting two years in duration. The reason that most retrofitting occurs is initially because of thermal comfort, energy saving is deemed to be a secondary concern but once a level of comfort is achieved energy saving moves more into focus. Most interviewees had experienced the cold in their homes or in previous properties; interviewees did not mind sharing their experiences of the cold;

Retrofitting can take place over many years and in the case of a retired couple (Interview 19) who in retirement are having replacement sash double glazed windows fitted this month 33 years after moving into their property. There becomes a convergence between the retro-fitting of homes and how those homes are used. A common situation that emerges is that homeowners in the course of constructing a large living family room including the kitchen, will also upgrade the overall insulation and heating standards of this space mainly as a result of the necessity to meet the current building regulation requirements, and taking this opportunity to enhance the living area with for example underfloor heating or secondary forms of heating such as wood burners. A large living family area has been created by 8 of the homeowners. Their comments indicate satisfaction with the results they have achieved;

In creating large living family spaces, or in the general extending of the home, the consideration of heritage and aesthetic values arises. The majority of the extensions extend beyond the existing footprint of the building and this may result in the loss of historic building fabric and potentially heritage features, for example chimney breasts, rear bays, windows and doors.

The decision to extend by (interview 2) whose large living family area has been recently completed was held up by heritage concerns; *'We made a compromise we kept an old fireplace and took out a chimney breast that was to get the kitchen in and extended at the back'. 'It took us 4 years of debate that one, because of altering the features'*. (Interview 2: Retired Couple).

3.3 RETRO-FITTING AND BALANCING RETRO-FIT WORKS

Homeowners were asked what retrofit measures they had installed in their homes and how they had balanced retro-fit works in the context of the features and materials of their homes that they found important or significant. Most of the

interviewees had some or all of the original sash-windows in their homes (14 out of 18) which may be explained by the fact that this is a conservation area and clearly contradicts with non-conservation areas (see Fouseki and Bobrova in this volume) where the picture is exactly the opposite.

Most homeowners had considered heat loss through the roof and in many cases had taken some action to top-up the loft insulation, however this had often been completed some time ago and the current depth and product types were rarely known. In 11 cases, loft insulation fitted but may not be up to recommended levels while in seven cases fitted Celotex or similar insulation under rafters was part of roof maintenance works or loft extension work.

The fitting of insulation under the floorboards of suspended timber floors was raised as a theme by five homeowners when only three homeowners had installed such insulation. The impact of this can be illustrated by the results emerging from the thermographic imaging of floors (Figure 1).

In Figure 1 the thermography results show the perimeter of the floor around the skirting board at a temperature cooler (blue) than that more central area of the bay (yellow) where the wooden floorboards may have been warmed by heat radiation through the windows (Figure 2).

A floor-joist can also be detected running top to bottom of the image. When this image is compared to the thermographic results from the comparison property which has no insulation under the floorboards, warm air can be seen to be channelled into the house from an area which corresponds with an airbrick on

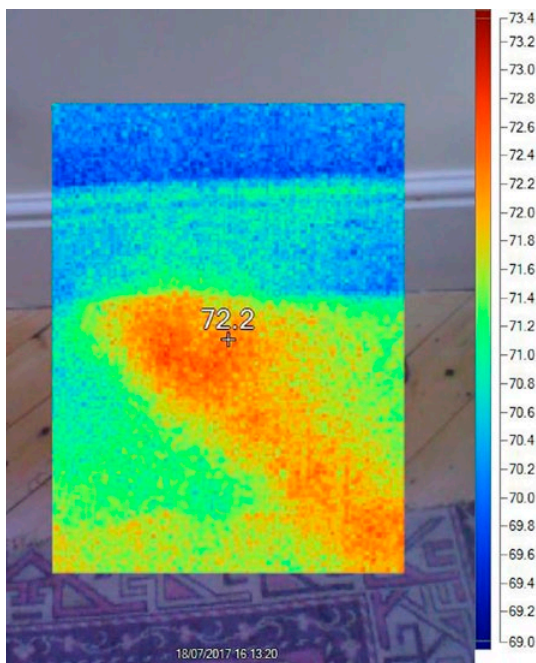

Figure 1. Thermographic image uninsulated suspended timber floor–Bay window area of the Edwardian comparison house.

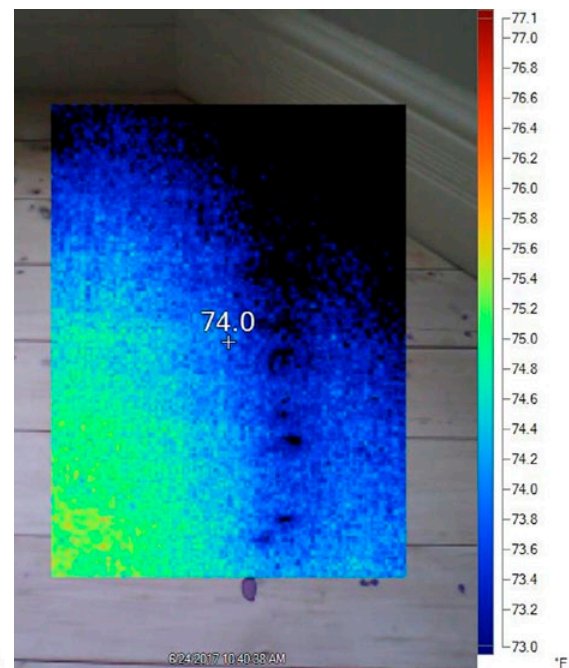

Figure 2. Thermographic image of the Bay window area.

the outside of the property. This is warming the floorboards in the immediate bay area, with warm air also seeping through the gaps in the floorboards.

4. MAPPING THE DYNAMIC INTERACTION BETWEEN SPACE, HERITAGE VALUES AND ENERGY EFFICIENT RETROFITTING

The next step of the thematic analysis of our interviews was to map the systemic and dynamic interactions between heritage values, space and energy retro-fitting decisions on Vensim, a software commonly used for system dynamic analyses, in order to identify the critical variables that determine certain decisions on certain energy efficiency measures. Here, the wider context is a conservation area with which homeowners are attached. It is within this context that we need to understand the systemic interactions of the aforementioned variables. Figure (3) shows a causal-loop map designed on Vensim – this is a map that illustrates the causes and effect of a phenomenon in loops. Loop 1 (R1) indicates that the more original features in an old building, the higher the cultural values, and the higher the satisfaction. However, once the physical condition of the original features deteriorates over time homeowners are choosing between three main options including replacement, restoration/preservation and replication with modern materials (see boxes in the diagram). The option will very much depend on the type of intervention. Interior insulation seems to be preferred for increasing thermal comfort if space allows (see Balancing loop B4). However, if space

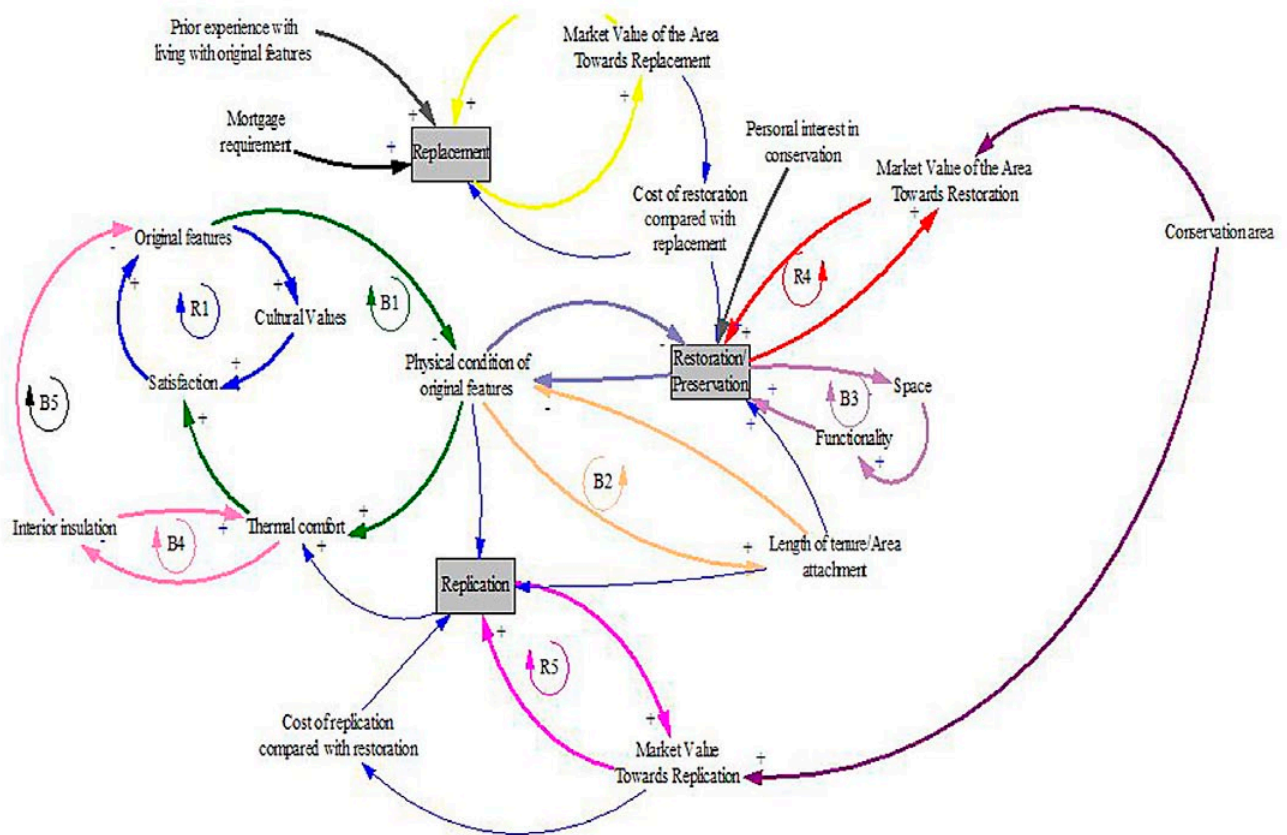

Figure 3. Causal-loop diagram of interactions on Vensim.

is limited (see Balancing loop B3 in the diagram) there is more preference on restoring/preserving rather than interior insulation. It is worth pointing out here that exterior insulation is not an easy option in conservation areas. Restoration and preservation is also dictated by personal interest in conservation, the wider area and how it values the market value of original features (see R4 in the diagram) and the costs. Finally, replacement will mainly be driven in the conservation area by either mortgage requirements or prior negative experiences with living with original features.

5. DISCUSSION

What the results above indicate is that homeowners' decisions on improving the energy performance of their residence will depend on multiple factors that are in interaction with each other. Hence, the decision-making on this matter is a complex and systemic process that moves beyond a simple tension between thermal comfort and heritage values/preservation. In addition, homeowner's decisions on retro-fit measures are facilitated by conferring with others in their streets for advice and seeking help from independent professionals such as architects. Retro-fitting is carried out incrementally and progress is generally over many years. All homeowners are reluctant to lose any heritage features and where windows are removed these are kept in most cases. This finding contradicts findings from other cultural and social contexts where residents are keen to sacrifice original features if they affect negative thermal comfort (see Fouseki and Bobrova in this volume and Koukou and Fouseki in this volume). Replacement joinery double glazed windows are a measure some have adopted and others have shown an interest in.

It emerged from the interviews that there are a high proportion of houses within the sample group that have a rear extension, 15 out of 20, many of these are used as large living family areas normally including the kitchen, many of these spaces are relatively new and will comply with more up to date building regulations and therefore potentially become the warmest space in the house.

In almost all cases original features are highly valued; all homeowners can remember what heritage features were contained within their house irrespective of how long ago it was bought, even if it was almost 40 years ago. Where houses are extended, a trade-off between heritage values and user comfort is required and this was found to be a process that was carefully thought through. This finding is reaffirmed by a similar study in the context of Cambridge carried out by Sunikka-Blank and Galvin [8] who also point out the careful and lengthy decision-making process that homeowners in Cambridge undertake as well as the diverse ways in which they express the idea of aesthetics and heritage values.

Many homeowners who had not created specific large living areas in their homes through construction works, spoke about the cold they endured in their homes. Retrofitting was undertaken as a means of providing comfort in the first instance. The need to save energy became secondary, but as homes became warmer as a result of more extensive retrofitting, energy costs moved more into focus.

6. CONCLUSION

From the sample of Cambridge homeowners interviewed, in almost all cases original features were highly valued. Where retrofitting is carried out incrementally and over many years there appears to be a high retention of original building fabric and features, although it is noticeable particularly with those in or around retirement age that replacement joinery windows are being installed and considered.

It is not clear when large scale contractor works are undertaken, which may include renovation and retrofitting, whether as much of the original building fabric and period features are saved as is possible. Irrespective of how keen homeowners are to preserve as much as they can, decision making on site may put historic features and materials at risk. This may be an area for future research.

Many homeowners who have expressed the most satisfaction with the comfort levels of their homes have created large living family spaces within and it is from this position retro-fitting continues and comfort levels improve further in other areas of the house as different measures work in an integrated way, for example, secondary double glazing, underfloor insulation and secondary forms of heating and zoning. There were no significant problems reported with any type of retrofitting, including those who had fitted internal insulation. There were some minor instances of condensation within secondary double glazing. These observations were further validated by spot-thermal imaging captures.

The main limitation of the research may lie within the demographic of the sample group of whom all were middle class and financially comfortable. Similar housing stock around the UK may not benefit from the levels of investment that Cambridge homeowners decide to make in their properties.

However, this piece of research is important in the wider field of sustainable heritage because it directly engages with a group of homeowners who, in giving a generous amount of their time, have allowed an insight into living in Victorian and Edwardian homes many of which display original features but which may have started out as being difficult to heat. These homeowners become custodians of heritage buildings and balance the values that are important to them with the underlying problems that they face. Ultimately, it is up to the homeowners to decide and justify, mainly to themselves, which measures are appropriate. Their often slow and careful steps seem to bring the desired results.

For future research, we would like to see more socio-technical studies that attempt to collect and synthesize social and technical data. There are certainly challenges in this approach, especially if applied in the context of everyday residences. Environmental data and thermal imaging data measured for at least a year as well as social data via interviews and other qualitative methods do take time and require the establishment of prior trust with the residents. However, it is worth starting developing longer-term studies of this type so that we will be able to better articulate how the complex system of a historic house changes over time

and what the best strategies to balance heritage significance and environmental sustainability are.

7. REFERENCES

- [1] M. Sunikka-Blank and R. Galvin. (2016) "Irrational homeowners? How aesthetics and heritage values influence thermal retrofit decisions in the United Kingdom". *Energy Research & Social Science*, [Online] 11, pp. 97–108. Available: <https://www.sciencedirect.com/science/article/pii/S2214629615300566> [Jan. 20, 2017].
- [2] K. Fouseki and M. Cassar. (2014) "Editorial: Energy Efficiency in Heritage Buildings: Future Challenges and Research Needs". *The Historic Environment*, [Online] 5 (2), pp. 95–100, <https://www.tandfonline.com/doi/full/10.1179/1756750514Z.00000000058> [Jan. 21, 2017].
- [3] F. Berg, A. Flyen, A. Godbolt and T. Broström (2017) "User-driven energy efficiency in historic buildings: A review". *Journal of Cultural Heritage* [Online] Available: <https://www.sciencedirect.com/science/article/pii/S129620741730362X> [Dec.20, 2017].
- [4] M. Suhr and R. Hunt. *Old House Eco Handbook*. UK: Frances Lincoln Limited, 2013.
- [5] S. Eker and N. Zimmermann, N. (2016) "Using Textual Data in System Dynamics Model Conceptualization". *Systems*, [Online] 4 (3). Available: <http://www.mdpi.com/2079-8954/4/3/28/htm> [June 15, 2017].
- [6] K. Fouseki and Y. Bobrova (in this volume) Understanding the Change of Heritage Values and its Impact on Energy Efficiency Decision-Making at Residential Historic Buildings Through System Dynamics.
- [7] C. Gilleard, M. Hyde and P. Higgs. (2007). "The Impact of Age, Place, Aging in Place, and Attachment to Place on the Well-Being of Over 50s in England". *Research on Aging*, [Online] 29 (6), pp.590–605, Available: <http://journals.sagepub.com/doi/abs/10.1177/0164027507305730> [Aug. 21, 2017].
- [8] M. Sunikka-Blank and R. Galvin 2016. Irrational homeowners? How aesthetics and heritage values influence thermal retrofit decisions in the United Kingdom. *Energy Research & Social Science*, 11, pp.97–108.

Balancing cultural and environmental values in buildings refurbishment

Assessing integrity and energy

J. Mourão¹ and V. Campos²

¹ Center for Innovation, Technology and Policy Research (IN+) Instituto Superior Técnico (IST) Lisbon.

² Urban and Territorial Studies Unit (NUT) Nacional Laboratory of Civil Engineering (LNEC) Lisbon, Portugal. Email: joana.mourao@tecnico.ulisboa.pt; vcampos@lnec.pt

Abstract – Considering the current challenge of environmental efficiency, urban policies should aim to improve existent buildings' environmental performance by improving their energy performance. Building energy refurbishment solutions should also be weighed against the preservation of the building's integrity and cultural value. This paper discusses criteria for the assessment of the impacts of urban buildings refurbishment, considering the risks and opportunities for both their cultural values and environmental resources.

After a brief review of the operational concepts and the technical and policy references, the paper presents an assessment grid, developed in the framework of the research project “Decarbonizing Cities: assessing urban and building rehabilitation impacts on urban metabolism and heritage”, focusing on the trade-off between cultural integrity and embodied energy preservation. Two case studies are presented to illustrate the use of the assessment grid.

Keywords – urban buildings' refurbishment; heritage cultural values; environmental resources efficiency

1. INTRODUCTION

The inherited urban building stock that makes up for most of our European cities, is a valuable societal asset that by far exceeds the individual building's market value. This building stock is the result of a long additive process through time, embodying both material and immaterial resources and values that no society can afford to disregard and waste. Refurbishing and improving on this building stock is thus a common-sense approach. In line with these ideas, building refurbishment and urban regeneration have become major priorities in Portuguese urban policy, succeeding over six decades of urban sprawl and lesser attention to the existing city. Combined with renewed attention to energy efficiency, this change of direction in urban policy is not free from difficulties. Under the general notion of refurbishment, different approaches to the existing building stock are coexisting, many of them resulting in an actual loss of value, both cultural and environmental, even if the objective of increased operational energy efficiency is achieved.

This paper is based on preliminary results from the research project “Decarbonising Cities: assessing urban and building rehabilitation impacts on urban metabolism and heritage”, designed to develop operational tools and

criteria to conciliate cultural values and environmental resources efficiency when implementing policies. It presents a scoring grid designed to estimate impacts in building refurbishment (chapters 4 and 5) and a brief review of concepts and references (chapters 2 and 3).

2. SOME OPERATIONAL CONCEPTS

2.1 CULTURAL VALUE VS ENVIRONMENTAL EFFICIENCY

Conserving *environmental resources* in buildings can help to preserve *cultural values* [1]. However, these aspects tend to be perceived and managed separately: cultural heritage assessment addresses immaterial values, such as authenticity, significance or integrity, while environmental assessment addresses resources, such as operational and embodied energy.

2.2 URBAN BUILDING STOCK CULTURAL VALUE

(a) Integrity

Integrity is defined in the European standard EN 16883 [2] as *the extent of physical or conceptual wholeness of a building*. Integrity represents also the matching between a building and the original societal context in which it was built, considering the technical resources and aesthetical standards of that time. Levels of integrity have been considered as a material dimension of the built heritage, despite representing also immaterial dimensions.

(b) Authenticity

Authenticity is defined in EN 16883 [2] as *the extent to which the identity of a building matches the one ascribed to it*. It refers to a correspondence between a way of living and production, in a certain place and time, and the building as it is now. It can be a criterion for selective conservation but it should not hamper the modernisation interventions in buildings, with their own authenticity. Following the ICOMOS Nara document on authenticity, a grid for building elements validation was defined [5]. This grid does however not consider the addition of new levels of authenticity by new interventions in buildings.

(c) Significance

Significance is defined in EN 16883 [2] as *the combination of all the heritage values assigned to a building and its setting*. Despite being frequently used to analyse listed heritage by UNESCO or ICOMOS, “*there is probably no simple or comprehensive set of rules by which this significance can be valued*” [6]. In urban built heritage, significance assessment is multi-dimensional. Some authors assess significance in a quantitative way, through the identification of character-defining elements and of the way interventions impact on it [7].

2.3 URBAN BUILDING STOCK ENVIRONMENTAL EFFICIENCY

Assessment of the urban building stock environmental efficiency aims to measure natural resources consumption to achieve a certain performance, contributing to predict life cycle environmental impacts. It relies on industrial ecology methodo-

logies such as Life Cycle Analysis (LCA) which comprises production, operation in-use and end of life phases of products. LCA can also be applied to the urban building stock. This methodology addresses environmental resources as raw materials, water, ecosystems, climate change, but it can focus only on energy (Life Cycle Energy Assessment–LCEA). In LCEA impacts are measured in primary energy and CO₂ emissions.

(a) Operational energy

The amount of energy demanded to meet the requirements of a building in-use is called *operational energy*. The building functions, which have substantial operational energy demands, concern mainly environmental comfort: heating, cooling, ventilation and lighting. Bioclimatic-sensitive architecture can reduce operational energy demand for environmental comfort at a low cost. Renewable energy and energy efficiency technologies can also reduce it, at a higher investment cost. Operational energy demand is also dependent from user behaviour.

Conflicts between winter and summer operational energy needs are identified as a barrier to the definition of optimal operational energy reduction measures [8]. In southern Europe climate, construction traditions and social factors, which justify a low energy demand for comfort, are not always being considered, leading to an overestimation of energy consumption.

(b) Embodied Energy and LCEA

The *embodied energy* corresponds to the energy spent in the materials and processes implied in the production and refurbishment of the building stock. Regarding buildings, it is common to refer the proportion of 20 percent of embodied energy to 80 percent of operational energy. However, these values refer to overestimated consumptions, exclude refurbishment embodied energy additions through time, do not consider the whole cycle and neglect the traditional buildings high embodied energy [1]. Measures aimed to reduce operational energy may lead to an increase of embodied energy due to demolition and waste disposal of old materials, and due to transportation and incorporation of new materials [10].

LCEA adds to *operational energy* the *embodied energy* related to construction materials and processes, offering a comprehensive approach to environmental efficiency of the building stock [11]. In general, LCEA relies on data bases that do not include embodied energy in traditional pre-industrial materials and processes, since such measuring requires complex historical research.

3. REFERENCES ON BUILDING REFURBISHMENT IMPACTS ASSESSMENT

3.1 TECHNICAL REFERENCES

The *European Guidelines for Improving the Energy Performance of Historic Buildings* (EN 16883: 2017) [2] aim to achieve a sustainable balance between the use of a building, its energy performance and its preservation and conservation, assisting in the choice of the most appropriate energy efficiency measures. This European standard envisions actions aimed strictly to improve energy

performance. Current urban building stock refurbishment, with no direct energy efficiency purpose, is not considered.

According to EN 16883, the condition of the building envelope and technical systems shall be surveyed, repaired and optimized before considering improving energy performance. User behaviour as a factor of energy consumption shall also be observed. Only after this, a decision shall be made on the need of improving energy performance through specific measures.

The building survey shall describe: i) heritage significance and conservation opportunities and constraints; ii) past and present uses; iii) structural system; iv) energy performance assessment; and, v) indoor environmental assessment. The standard refers to other standards (EN 15603) for tailored energy performance assessment of existing buildings, not advising the use of the same methodology for the pre-existence and after refurbishment.

The categories used by the standard to select the best energy efficiency measures (concerning the building envelope, the technical systems and user behaviour) are: i) technical compatibility with the existing structural, constructional and technical systems, referring to risks and reversibility levels; ii) heritage significance, including physical and design integrity; iii) economic viability; iv) energy, including operational energy demand and embodied energy, v) indoor environmental quality; vi) outdoor environment; and, vii) use.

The standard presents an example of an assessment table to be applied, measure by measure, in each of these categories (Annex B). This example is suitable for the evaluation of energy performance improvement measures. However, since energy performance is not always the main driver of building refurbishment, this example is not suitable for the evaluation of the impact of general refurbishment works on energy performance.

The procedure set by EN 16883 includes heritage cultural significance criteria (see 2.1) and operational and embodied energy criteria. It does not include urban integrity and architectural integrity as specific criteria, encompassing them in “physical and design integrity”, which shall be evaluated in terms of material, visual and spatial impact. It also does not contain its own guidelines for operational energy simulation, forwarding to EN 16096, EN 15603 and EN 16247. Concerning embodied energy, it refers to EN 15643–2, a standard regarding new buildings and materials, lacking specific information for pre-industrial construction.

Contemporary to the development of EN 16883, “*Energy Efficiency in European Historic Urban Districts*” (EFFESUS) [12] was an innovative project which produced public reports and a Decision Support System (DSS) and software with impact assessment modules matching the assessment categories of EN 16883. The DSS requires location-specific information and technical data, which are not location-specific, such as retrofit measures.

While location-specific data allow the consideration of local climate aspects, the not site-specific repositories of measures can result in a lesser consideration of

specific cultural and constructive aspects (e.g., the role of stone and mortar and vapour-open construction techniques in comfort [13], [14]). EFFESUS developed repositories containing measures to retrofit building fabric and technical building services (e.g. conventional insulating systems; slim-profile insulating systems; insulating coatings) and to decarbonise the energy supply (e.g. solar photovoltaics for pitched roofs) [12], [15]. Rodwell and Hermann [7] evaluated the impacts of these measures on heritage significance and character-defining elements, providing a balancing procedure that, despite being conceived for energy retrofits, can be adapted to refurbishment operations with no direct energy efficiency purposes.

3.2 POLICY REFERENCES

The development and publication of EN 16883 is contemporary of European policies on heritage conservation, such as the European Cultural Heritage Strategy for the 21st Century (2017), the report Cultural Heritage Counts for Europe (2015) and the recent initiative of the European Commission to make 2018 the European Year of Cultural Heritage. The European Cultural Heritage Strategy for the 21st Century presents recommendations to protect, restore and enhance heritage, making use of new technologies and to develop knowledge banks on local and traditional materials, techniques and know-how.

These endorsements, on new technologies and on traditional know-how, are not equally considered in EN 16883, since the standard focus mostly on enhancing heritage, making use of new technologies for operational energy demand, while focusing less on embodied energy and passive performance, which can be achieved by better knowledge on traditional construction.

Recently, packages of measures of building “energy refurbishment” emerged with ecological purposes at the scope of the International Energy Agency [17] and the Intelligent Energy European Programme of the European Union (NZEB and SZEB initiatives). In most cases these initiatives were aimed at the post-war social housing stock and do not predict ways to regulate intervention in pre-industrial of buildings.

Mainstream energy refurbishment measures consist of increasing thermal insulation and air tightness of the building envelope aiming to reduce energy consumption. Cost-efficiency, performance of active systems and integration of renewables are key issues. However, this kind of energy refurbishment, even following certification schemes, does not always result in energy savings (as the methodologies used do not consider passive environmental performance and do not suit older buildings and mild climates in southern Europe [18], [19]). User behaviour, adaptive comfort and energy prices are also not always considered in the assessment of energy refurbishment packages.

4. A FRAMEWORK FOR REFURBISHMENT IMPACTS ASSESSMENT

4.1 BUILDING AN ASSESSMENT GRID

The mainstream concept of *building energy refurbishment* addresses operational energy performance as a factor prevailing over others. However, during its long

lifespan, the urban building stock collects cultural values and other environmental resources, which are inseparable. Comprehensive assessment tools and methods, able to take into consideration both cultural values and life cycle environmental resources in a related way, are thus needed. With this purpose, based on the reference framework outlined in chapters 2 and 3, an assessment grid was developed, relating two sets of analytical dimensions: the building's urban context, architectural features and environmental attributes, to different types of interventions in buildings (Table 1).

Three urban context factors are considered in the assessment grid: (1) *urban morphology 2D* – plot structure and street pattern; (2) *urban morphology 3D* – volume, considering the original characteristics of the building and of adjacent buildings; (3) *public space interface* – building contact with adjacent public space, in general at the ground floor.

Four architectural features are considered; (4) *type of construction* – structural system and primary construction elements; (5) *architectural typology* – spatial organization and secondary elements; (6) *social use* – the original activities the building was built for and their relation to the new use of the building; and (7) *character defining elements* – elements that contribute to the *heritage significance* and to the building's identity.

Eight environmental attributes are considered: (8) *high embodied energy materials* – a selection of materials, mainly structural, which have high energy value, and thus should not be lost (9); *passive operational performance elements* respecting thermal and environmental comfort (10 to 14); and *active energy systems* (15) for energy saving through technical equipment (central heating, solar hot water, solar PV, HAVAC).

At the other grid axis, six different types of interventions in buildings are considered: i) *full preservation*, where the building is returned to its original state, when known; ii) *high preservation and optimization*, where the building suffers minimal interventions for improving functional and/or environmental performance, mostly on the envelope; iii) *medium preservation and optimization*, where the building suffers a deeper intervention, namely structural reinforcement, technical facilities replacement and/or changes in inner lay-out; iv) *partial preservation plus extension/addition*, where the building is enlarged in height, depth or width; v) *low preservation and reconstruction* (e.g., façade preservation only); vi) *no preservation/total reconstruction*, where the building is demolished and replaced (even if by a mimetic construction).

Each cell in the grid is scored using the five categories found in Annex B of EN 16883, from high risk (--) to high benefit (++) . Scoring criteria is still under development in the research project. Scoring shown in Table 1 is related to the case studies (see chapter 4.2). The table can be used as a scorecard when applied to refurbishment operations. The grid is applicable not only to energy refurbishment but also to other interventions on buildings which have impacts also in energy and environmental performance. As for the EN 16883 assessment table, this grid should be applied after the building survey has identified

pre-existing values and conditions. The grid can be applied even when the building does not need energy improvements.

Table 1 – Assessment grid and impact scoring

Urban context, architectural features and environmental attributes		Types of interventions in buildings					
		I	II	III	IV	V	VI
1	Urban morphology 2D	++			+		
2	Urban morphology 3D		+		-		
3	Public space interface	++					--
4	Type of construction	+		-	/		--
5	Architectural typology				+		-
6	Social use		+		+		
7	Character defining elements	++				--	
8	High embodied energy materials	++					--
9	Waste	++					--
10	Thermal inertia	++			-		--
11	Solar control		+		+		--
12	Vapour open/Air tightness	++			/		--
13	Natural ventilation		++			/	
14	Insulation	-			+		+
15	Active energy systems				+		++

4.2 TESTING THE GRID

To test the assessment grid, two case studies were selected, located in a central Lisbon residential district. Both were recently refurbished, though with different approaches. Case study A is a residential building erected in the late 1700's using the then traditional techniques common in Lisbon (coarse stone and lime mortar for outer walls and timber for floors, partitions and roof). The plot was part of a subdivision of land based on the square grid. The pre-existing building was preserved and one floor was added.

Case study B is a residential building erected in the early 1900's using then current building techniques (brick walls and timber floors and roof). The plot is in the same area as case study A, with the same historical background. The pre-existing building was demolished and replaced by a new building.

Both original buildings presented some integrity, although the first had higher authenticity and significance, as an exemplar of the initial settlement in the area. The structural systems were in good condition, though affected by seismic vulnerability. Energy performance by the Portuguese certification system was low (F for case A and D for case B).

In case study A, levels of preservation of building elements range from I to IV (columns in Table 1). The scoring assigned (cells in light grey) for each feature



Figure 1. Images of the case study buildings before and after refurbishment. Photos: Joana Mourão.

from the grid (lines in Table 1) considered: the urban plot structure was preserved (1) but the building was extended in height (2). Ground floor interface was not changed (3). The original construction was preserved partially and reinforced, and a new light weight construction was added for the new floor and roof (4). The inner layout was kept, and use is the same as the original house (5, 6). Character defining elements (window stonework and inner stairs) were kept (7). High embodied energy structural materials were preserved (8) and waste was minimized (9). Passive performance was optimized and improved (10–13) and the roof was insulated (14). Water solar heating was added on the new rooftop (15).

In case study B levels of preservation of building elements range from II to V (columns in Table 1). The scoring assigned (cells in dark grey) for each feature from the grid (lines in Table 1) considered: the urban plot structure was preserved (1). The original volume was reproduced, with a recessed upper floor (2). The ground floor now includes a garage facing the street (3). The original construction was replaced (4) and an open-space inner layout was adopted in place of the previous partitioned layout (5), although the use is the same (6). Character defining elements were replaced by others that contrast with adjacent buildings (7). Embodied energy of the original building was lost as waste (8,9). Passive performance relies only on new windows and envelope insulation (10–14). Solar water and HAVAC were introduced for high standard environmental comfort (15).

Applying the grid to case study A, the impact score totals +19, which is 60 percent of maximum benefit (+30 score). For case study B the impact score totals –11, which is 40 percent of maximum risk (–30 score). These results are in line with the empirical assessment of the two cases in terms of urban, architectural and environmental performance:

- case study A shows that the addition of a floor can be compatible with the preservation of urban and architectural integrity and good environmental performance;
- case study B shows that replacing a building has significant risks for cultural values and environmental resources.

5. CONCLUSION

The grid presented in this paper is still a preliminary result of the research project. Ongoing research includes the analysis of urban and heritage policies in Europe and the assessment of policies and practices in Portugal. Validation of the grid with its scoring system, establishing the scoring criteria and adding a support grid for the assessment of the values and resources previously to the refurbishment, will require further development and testing. For that purpose, a suitable range of cases representing different approaches to urban building refurbishment and different building types will be selected and analysed.

6. AKNOWLEDGEMENTS

The authors thank the Portuguese Foundation for Science and Technology (FCT) for supporting the research project (FCT grant SFRH/BPD/118089/2016).

7. REFERENCES

- [1] U. Munarim, E. Ghisi “Environmental feasibility of heritage buildings rehabilitation” *Renewable and Sustainable Energy Reviews* 58 pp. 235–249 2016.
- [2] European Committee for standardization (CEN/TC 346) EN 16883: 2017 “Conservation of cultural heritage. Guidelines for improving the energy performance of historic buildings” 2017.
- [3] K. Van Balen “The Nara grid: an evaluation scheme based on the Nara document on authenticity” *APT Bulletin* 49 pp. 39–45. 2008.
- [4] P. Faulkner “A Philosophy for the Preservation of our Historic Heritage” *Journal of the Royal Society of Arts*. Vol. 126, No. 5264, pp. 452–460. 1978.
- [5] C. Hermann and D. Rodwell “Heritage significance assessments to evaluate retrofit impacts: from heritage values to character-defining elements in praxis” in EFFESUS publications. 2015.
- [6] A. Webb “Energy retrofits in historic and traditional buildings: A review of problems and methods” *Renewable and Sustainable Energy Reviews* 77 pp. 748–759. 2017.
- [7] E. Grytli et. al. “The Impact of Energy Improvement Measures on Heritage Buildings, *Journal of Architectural Conservation*, 18:3 pp. 89–106. 2012.
- [8] M. Jackson “Embodied energy and historic preservation: a needed reassessment” *APT* 36 pp. 47–52. 2005.
- [9] EFFESUS Consortium—Energy Efficiency in European Historic Urban Districts. 2016.
- [10] R. Curtis “Energy efficiency in traditional and historic buildings: keeping it simple” in *Energy Efficiency and Comfort of Historic Buildings Proceedings* 2016.
- [11] V. Pracchi, “Historic Buildings and Energy Efficiency” *Historic Environment* v. 5, n. 2 pp. 210–225. 2014.
- [12] A. Egusquiza et. al. “Strategic assessment of historic cities for energy efficiency retrofits to enable their long-term use and conservation” in EFFESUS publications. 2016.

- [13] IEA–International Energy Agency–Shining Examples of Cost-Effective Energy and Carbon Emissions Optimization in Building Renovation (Anx56) Energy in Buildings and Communities Programme. 2014.
- [14] V. Rato “The importance of the external envelope within energy certification of residential buildings in Portugal, Portugal SB10: Sustainable Building Affordable to all. iiSBE Portugal, U. Minho, IST. 2010.
- [15] J. Flores “An investigation of the energy efficiency of traditional buildings in the Oporto World Heritage Site” in Energy Efficiency and Comfort of Historic Buildings 2016 Proceedings. 2016.

Character defining elements

Relations between heritage regulations, user perspectives and energy saving objectives

P. Eriksson

Dept., of Conservation and Art History, Uppsala University, Visby, Sweden

Abstract – The challenge to convert the Swedish building stock to the energy targets as it is set out in national building regulations applies to all buildings. Likewise planning and building legislation states that all buildings should be treated with caution regarding actions that could cause losses of technical, historical, environmental and cultural values. By using the world heritage city of Visby as a case study this paper aims to deepen the understanding of how these values are embedded in the physical expressions through identifying the character defining elements, of buildings. This is performed by examining what is stated by experts in official documents and by non-experts through questionnaires and workshops with house owners and inhabitants. By a transparent designation of character defining elements the advantages of energy improvements can be more clearly balanced with possible losses of value. The outcome of this study will contribute to a method where the better understanding of how heritage values are defined by characteristic elements, from both a top down and a bottom up perspective can help to improve policies and guidelines for adopting energy improvements in existing buildings.

Keywords – historic buildings, cultural significance, heritage values, character defining elements

1. INTRODUCTION

1.1 BACKGROUND

The challenge to improve energy performance in existing buildings in tune with the objectives set out in the national Swedish building regulations is an urgent topic for the conservation sector as well as the renovation and building management sectors and is actualised by the national renovation strategy. [1] When renovating a building the national energy requirements set out in the Building Regulations must be achieved. At the same time the Planning and Building Act requires that all buildings should be treated with caution when implementing measures that could cause losses of technical, historical, environmental and cultural values. To achieve a sustainable balance between these demands, a method for LCC (Life Cycle Cost)-optimisation has been developed in a previous project [2]. A critical part of this method is to define what elements in the existing buildings represent technical, historical, environmental and cultural values. In current practice the designation of heritage values in buildings is carried out by experts leaving most stakeholders out of the process.

This paper examines how experts and non-experts define and interpret heritage values by asking them to identify which character defining elements in selected buildings should be protected when considering measures to improve energy performance.

1.2 AIM

The aim of his paper is twofold. Firstly to illustrate a method used to visualise the top down – bottom up relationship in identifying character defining elements of importance for heritage values in existing buildings. Secondly to examine how heritage values can be transformed into physical building elements that express the character of the buildings and how this relates to changes made to improve the energy efficiency of the buildings. More specifically this includes the following questions:

How are heritage values described and identified in official documents such as local and national building regulations compared to those values which are appreciated by people owning or living in houses identified as built heritage?

Is there compatibility on what should be protected between the expert statements in official documents and the views of house owners and inhabitants?

1.3 METHOD

The material used for the analysis consisted of local official regulations, along with the outcome of a questionnaire and a workshop as a basis for discussing the relationship between designated character defining elements and house owner/inhabitant opinions on what is worth caring for.

With the official local regulations, a summary of the elements identified in the document was used to illustrate what is considered important for the different building periods of the city of Visby.

A questionnaire to house owners and inhabitants was sent out during the autumn of 2016 (the web based questionnaire was open July – December 2016). 359 people living in Visby were asked by mail to participate in the survey. The questionnaire was divided into three main themes: the heritage value of the building, the technical state of the building including earlier renovation works, and a set of questions related to energy use in the building. The questionnaire also included questions about historic technical and aesthetical improvements of the building envelope and the satisfaction of the technical state of the building and if there were any planned actions to improve the building envelope. Demographic questions were also included. The questionnaire could be answered by mail using the web-based questionnaire. A reminder was sent twice and the information regarding the research was also disseminated through the association *Visby innerstadsförening*, an association founded to work with issues concerning the development of Visby historic centre. The return rate was lower than expected, only 14 % or 51 answers were collected.

A workshop was held in August 2016 to deepen understanding of how house owners and inhabitants in Visby understand and interpret heritage values and

character defining elements in the built environment. 23 house owners and inhabitants participated in this workshop. The workshop was designed in two parts with an introduction about the concept of heritage values and energy efficiency. In the first part of the workshop the participants were asked to mark on photographs of buildings from different time periods, representing the building history of Visby, what they considered as the character defining elements of the building and why they did so. Since value is a complicated concept, there was also an opportunity to identify other aspects of the building that could contribute to the overall value.

The participants had four minutes per photograph and they were not allowed any discussion with other participants of the workshop. In the second part of the workshop, the participants were asked to mark on photographs (using the same images as before), what changes they would accept in order to reach higher energy efficiency with regards to the values that they had considered in the first part of the workshop. The workshop was documented by collecting all the answers and processing them through a combination of quantitative and qualitative analysis.

1.4 THE CASE STUDY

The historic city of Visby was used as the case study in this paper. Visby was declared a Unesco world heritage city in 1995. It has a high number of listed and protected buildings (314 out of approximately 1200) that are covered by the national heritage legislation. The municipality of Gotland has developed a zonal plan regulating the building activities in the historic city centre of Visby. The zonal plan has been complemented with a local building regulation that describes the character of the built heritage. The buildings of Visby cover a time span starting from the medieval ages up to modern buildings of today. The most common type of building are wooden structures built in the middle to late 19th century. This study considers the general regulation which applies to all buildings.

1.5 CONCEPTUAL FRAMEWORK

The relation between the concepts of cultural significance, heritage values and material and immaterial characteristics of heritage assets need to be briefly described. In the report *Values and heritage conservation* by the Getty Conservation Institute, this relationship is expressed as follows: "*Values give some things significance over others and thereby transform some objects and places into heritage.*" [3] Heritage values have been structured in different typologies depending on time and context. Values can be directly tied to the fabric of heritage assets, or to more subtle aspects connected to identity and feeling of belonging. Values are assessed consciously or unconsciously by different stakeholders, from heritage experts to property owners and people simply experiencing a place as visitors. In the field of energy efficiency in historic buildings, the focus has mainly been on how to solve technical issues with respect to heritage values, how these values has been selected is often not clarified [4]. There is also a lack of tools and methods in the heritage sector to manage these issues. In recent years, the confusion on how to use the concepts

of cultural significance, heritage values and character defining building elements has led to attempts to clarify the relationship between them, as well as their meaning. In a Swedish context, the National Heritage Board has developed a new way of approaching the designation and evaluation of heritage which focuses on the processes where values are involved rather than the result. [5] The National Board of Housing, Building and Planning has provided guidance to the national planning and building act on how to understand the concept of heritage values as well as exemplifying a checklist on character defining elements. [6] The National Board of Housing, Building and Planning provides further guidance on how to assess and interpret concepts related to values in built heritage, but there is no common approach provided on how to apply this in reality. The relativity surrounding the concept of heritage significance is affecting how policies are formulated, heritage management is planned and conservation actions are taken. Clarification of processes where heritage significance is an important aspect has become one way of dealing with this dilemma and to contribute to a higher degree of transparency. [7]

In the field of energy efficiency and historic buildings, two standards have been developed and launched almost simultaneously. The European standard “Conservation of cultural heritage – Guidelines for improving the energy performance of historic buildings” and the American ASHRAE standard “Energy guideline for historic buildings” [8] [9]. The two standards give guidance on how to integrate energy efficiency measures in historic buildings in two different ways. The European standard suggests a procedural approach that could be applied to all buildings regardless of age, value, etc., while the American standard is a technical guideline that deals primarily with listed historic buildings. Both standards define terms and concepts connected to the specified fields. The two standards represent a movement towards a more uniform understanding of how aspects of heritage values can be integrated in an energy renovation process.

2. BUILDING REGULATIONS ON NATIONAL AND LOCAL LEVEL

The national law on housing, building and planning encompasses all buildings no matter whether they are listed or not. All changes to buildings are supposed to take into account the character of the building and the values connected to history, building technique, aesthetics and cultural history [10]. Further, the legislation has in later additions clarified how this could be interpreted. The clarification states that all changes should be made with respect to the character of the building when it comes to proportion, form, volume, material, colouring, construction work and the detailing of the building. [11] The compliance with this national law should be monitored by the local authorities/municipalities when deciding on building permits. Other stakeholders involved in decisions that could change the character of a building are required to comply to the legislation. Local building regulations and zoning planning should be used as decision support at this level.

In the local building regulations covering the historic city of Visby there is a description of the character defining elements of the buildings. The character

Table 1. Character defining elements of the buildings in Visby

	Medieval city (1100–1500)	Wooden city (1720–1830)	Bourgeois city (1830–1920)	Modern city (1920–2010)
				
Character defining building elements	Walls, vaults, wooden trusses, closed façades and masonry details.	Marked stone foundations. Visible and nonvisible timber frame constructions. Original roof constructions. Older clay tiles, metal sheets and roof paper covering. Original rendering. Original material and design of doors and windows. Moulded façade elements and chimneys.	Marked stone foundations. Older clay tiles, metal sheets and roof paper covering on the roofs. Traditional rendering on the façades. Original material and design of doors and windows. Moulding in render and steel, stone details. Chimneys, hangers and downpipes, balcony racks and stairs.	Clay tiles, metal sheets and roof paper covering of the roofs. Traditional rendering and wooden panels on the façades. Hand crafted design on doors and windows. Lining and frames.

defining elements are connected to the building envelope because the regulations are used mainly as guidance for both house owners and decision makers at the municipality of Gotland. A summary of the character defining elements identified in the regulation are collected in Table 1. The regulation does not prioritise different elements as more or less important. Each group of elements are presented in detail followed by guidance on how to treat them in case of change. For example, it is prohibited to change the character and material of the windows. [12]

3. RESULT-HOUSE OWNERS AND INHABITANTS PERSPECTIVES

3.1 QUESTIONNAIRE

Of those who replied to the questionnaire, the majority (70 %) are over 60 years of age. The majority, (53 %), have lived in their buildings more than 15 years and over 90 % plan to stay at least 10 more years or longer. There is an equal division between people living in apartment houses and single unit houses and approximately 80 % own the building or apartment they live in. 66 % described themselves as having a good knowledge about how to deal with the building if they were going to renovate it.

The analysis of the questionnaire is concentrated on the questions connected to the values and significance of the buildings. Among the respondents a majority (78 %), attributes their building with high or very high heritage values. Figure 1 shows the distribution of responses to the question which asked respondents to describe what elements contribute to the value of the buildings. The environmental context of the building, how it is placed in relation to other buildings and

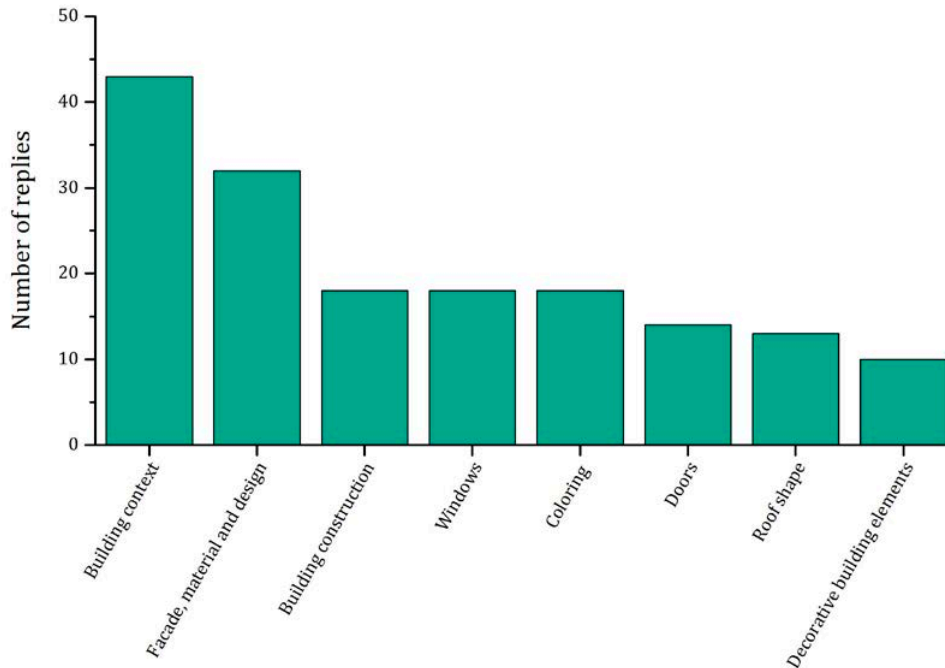

Figure 1. Distribution of answers from the questionnaire on what characters contributes to heritage value of the buildings.

urban structures, as well as the combination of material and design in the façade, are factors that are appreciated among a majority of the respondents. The construction, windows and doors and the roofscape produced fewer responses.

3.2 WORKSHOP

The outcome of the workshop is exemplified by one of the buildings in Table 1, the bourgeois building, which was used as a case study when designating values and discussing what changes can be made to improve the energy efficiency of a specific building. There were 22 elaborate individual responses from the workshop which could be interpreted as high involvement. Firstly, the participants were asked to describe the characteristics of the specific building, that contributed to its overall value. The responses included information about what was specifically regarded as beautiful and what was regarded as unsightly. Most of the responses indicated what was considered to be important for the character of the building. The expression and material of the façade and the roof shape and its material were ranked as being the most important elements followed by the windows. For this specific building, the steel works hangers and gutters were identified as being of importance.

In the second part of the workshop the respondents were asked to describe what could be done to improve the energy performance of the building without interfering with the characteristics that were defined in the first part. Almost all respondents mentioned that improving the windows was important as well as insulating the roof, floor and attic. The windows were identified as an important characteristic that contributes to the value of the building, but they were also the

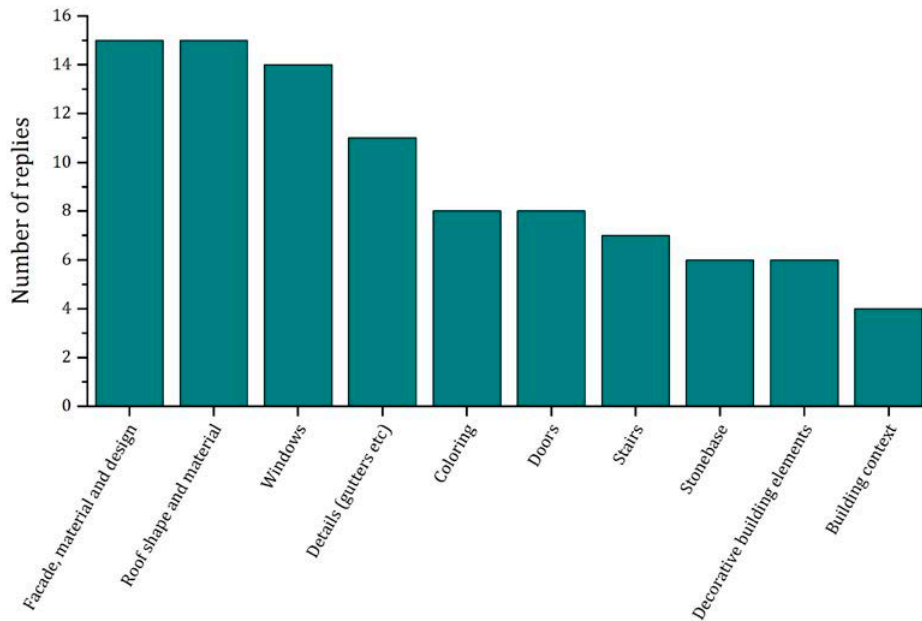

Figure 2. Distribution of answers from the workshop where the respondents were asked to express what characters defined the value of the bourgeois building shown in Table 1.

most frequently mentioned element when discussing possibilities for improving the building from an energy efficiency point of view. The responses were also clear about what measures are acceptable, such as adding secondary glazing to the existing window as long as it does not change the appearance of the window from the exterior.

The results show that the elements that were mentioned most often are those that are connected to the appearance in the façade and to the shape and material of the roofs followed by the windows. The overall appearance of the building envelope was prioritised by the participants of the workshop and the building in its context less so.

4. DISCUSSION AND CONCLUSIONS

It has often been assumed that there are discrepancies between what is expressed by experts and non-experts when it comes to what is important to preserve in built heritage. However in this case, there is conformity between the official guidelines on what designated characteristic elements defines the value and significance of the buildings in Visby and the opinion of the house owners and inhabitants. There is a difference though in how different character defining elements are prioritized by this group depending on how the questions are posed. In the questionnaire, the importance of the context of the buildings generated more attention than the workshop. The results from the workshop concentrated on the building envelope and especially on façades and roof elements. The façades, material and design, elements such as windows and doors are also identified in the local building regulation as important character defining elements. The study shows that there is a general acceptance of the local building regulations when it comes to identified character defining elements in the built heritage. This conformity is important

knowledge for the professionals and experts when developing strategies for a sustainable management of the built environment in Visby.

By using Visby as a case study area, a method of how to deal with issues of heritage values from a top-down and a bottom-up perspective for analysing two perspectives on the designation of character defining elements in the built environment, has been demonstrated. Although using Visby could be problematic, because of its specific context as a World Heritage city, and as the only representative of a Hanseatic medieval city in a national context, it can illustrate the relationship between different stakeholder opinions. This study gives an example of a methodological pathway where the official can interact with the public view on what kind of changes to the buildings due to efforts to improve energy performance are acceptable if account is taken of identified character defining elements.

5. ACKNOWLEDGEMENTS

The study has been performed as part of the now completed European Effesus project financed by the EU Seventh Framework Program and as part of the Swedish national research programme, Spara och Bevara, financed by the Swedish Energy Agency.

6. REFERENCES

- [1] Energimyndigheten, "Underlag för den andra nationella strategin för energi-effektiviserande renovering," 2016.
- [2] T. Broström, P. Eriksson, L. Liu, P. Rohdin, F. Ståhl, and B. Moshfegh, "A Method to Assess the Potential for and Consequences of Energy Retrofits in Swedish Historic Buildings," *Hist. Environ.*, vol. 5, no. 2, pp. 150–66, 2014.
- [3] E. Avrami, R. Mason, and M. de la Torre, "Values and Heritage Conservation," 2000.
- [4] M. Sunikka-Blank and R. Galvin, "Irrational homeowners? How aesthetics and heritage values influence thermal retrofit decisions in the United Kingdom," *Energy Res. Soc. Sci.*, vol. 11, pp. 97–108, 2016.
- [5] C. Genetay and U. Lindberg, "Plattform Kulturhistorisk värdering och urval Grundläggande förhållningssätt för," 2015.
- [6] "National board of housing, planning and building." [Online]. Available: <http://www.boverket.se/sv/PBL-kunskapsbanken/Allmant-om-PBL/teman/kulturvarden/exempel-/checklista-karaktarsdrag/>. [Accessed: 17-May-2017].
- [7] P. Marquis-Kyle and M. Walker, *The illustrated Burra charter Good practice for Heritage Places*, 3rd ed. Australia ICOMOS, 2004.
- [8] "Conservation of cultural heritage – Guidelines for improving the energy performance of historic buildings CEN/TC 346." CEN European standard, 2017.
- [9] "Ashrae Guideline 34P–Energy Guideline for Historic Buildings." ASHRAE, Atlanta.
- [10] *Plan och bygglag (2010:900)*. Sweden.
- [11] *Boverkets byggregler (BBR BFS 2011:6 – BFS 2016:6)*. Sweden.
- [12] M. Hallberg, "Byggnadsordning för Visby innerstad." Samhällsbyggnadsenheten Region Gotland, pp. 78–79, 2010.

Heritage, social values and the threat of ruination

T. van der Schoor

Knowledge Centre NoorderRuimte, Hanze University of Applied Sciences, (HUAS), Groningen, The Netherlands. Email: c.van.der.schoor@pl.hanze.nl

Abstract – Valuation of heritage buildings is usually performed by architectural-historical experts, who use a typology of heritage values based on conservation philosophy. Increasingly, social and spiritual values are included in heritage assessment frameworks. In the Netherlands earthquakes caused by gas mining seriously threaten hundreds of heritage buildings, both by necessary repairs and by the proposed strengthening operation. Inhabitants strongly argued for incorporating energy neutrality in repair, strengthening and restoration plans. Recently, a heritage evaluation framework was published for the assessment of strengthening plans. In this paper, we compare experts' and laypersons' values. We find that the public fears for loss of character of historic towns. Moreover, ambitions to pair opportunities of heritage and energy are not realized. We conclude that the evaluation framework is successfully incorporating social values. Furthermore, we recommend combining the framework with energy assessment. This could increase the chances for pairing opportunities of restoration and energy neutrality.

Keywords – valuation systems; social values; gas-induced earthquakes; liveability; ruination

1. INTRODUCTION

“Earthquakes are just a fact of life,” said Dutch Minister Kamp in 2014 after gas induced earthquakes again hit in Groningen, the province in the Netherlands that is situated above the ‘Groningen field’. Although he later regretted the cynical tone of his remark, it is true that earthquakes will probably continue to cause damage and unrest for years, if not decades to come. Groningen is a culturally rich endowed region which boasts medieval churches, castles, historic farms and characteristic townscapes. Sadly, more than 50 percent of the historical buildings in the earthquake-region are damaged due to the gas-quakes, while in some municipalities this is up to 90 percent. The threats of ruination and loss of character due to the gas-induced earthquakes generated a storm of protests by citizens and heritage organizations in Groningen.

“Ruins and moments of breakdown make infrastructure visible to every-one involved; it is momentarily acute”[1]. In Groningen, the gas infrastructure that was built up since the beginning of the 1960s used to be a rather unobtrusive part of the landscape. Indeed, infrastructure often is “by definition invisible, part of the background for other kinds of work” (Star 1999, 380). However, it is after the earthquake in Huizinge in 2012 that the underground gas fields became explicitly visible to both politicians and the public.

Infrastructures represent not only utilitarian arrangements, but they also embody structures of power. The present situation in Groningen draws our attention to the power structure, which lurks behind the unremarkable gas stations dotted in the Groningen countryside. “These sorts of seepages and disruptions draw attention to how permeable infrastructure is: appearing strictly utilitarian but always also embodying larger structures of power and direction” [1]. The Dutch gas-regime, in Dutch called ‘gasgebouw’, was set up in the 1960s. The Dutch state and two oil companies shared the profits of the sale of gas and the companies are jointly responsible for compensation of damages caused by gas mining. Until recently, the gas mining company (NAM) had a very dominant position regarding the damage caused by gas-quakes, presently reaching a total of 87,739 claims.¹ Furthermore, NAM takes the economic value of buildings as their only reference point, not accounting for cultural-historical values. This attitude unfortunately extends to listed buildings.

Not surprisingly, people in Groningen increasingly feel like “the local population who live in the “background” of infrastructures that are constructed solely to channel resources to other more distant populations” [1]. The situation leads to psychological effects, such as depressions [2], negative effects on the housing market, and increased migration from the area [3]. Consequences for local heritage are severe. Many characteristic buildings have already vanished, as is recorded by the Monitor ‘Het Verdwenen Groningen’. Heritage buildings are threatened by earthquakes in two important ways. The first is obviously the direct damage to the fabric, artwork and construction of heritage caused by the repeated incidence of (minor) earthquakes. The second major threat is the so-called strengthening operation that is meant to protect the inhabitants of heritage structures in case of a more severe earthquake. Consolidation of the structure is expected to lead to considerable damage to the cultural-historical qualities. Furthermore, this operation can render the building unfit for use. Citizens’ groups have argued that repair, restoration and strengthening should go hand in hand with energy measures, aiming for energy neutral and gas-free buildings.

To provide municipalities with tools to assess the repair and strengthening plans for heritage buildings, a new evaluation framework, called the ‘Heritage and Earthquake Framework’ (HEF) has been prepared under the auspices of the Dutch National Heritage Agency (RCE) [4]. One of the recommendations was to declare unsafe heritage buildings ‘ruins’, which led to public outcry. The RCE quickly issued a statement that it regretted the impression this made on the public and restated their ambition to protect historical buildings.

The purpose of our research is to investigate the strategies that are used to balance conflicting demands and values regarding historical buildings and townscapes. In this paper, we investigate how the HEF helps decision-making on proposals for ‘earthquake-proofing’ historical buildings. Furthermore, we will bring

1) www.dwarshuis.com

in public discourse on heritage and earthquakes, with the aim to examine how competing discourses are settled. Following the structure of the HEF, we focus on three aspects: cultural historical values, safety, and livability, and in particular, how these aspects are balanced. We also investigate what difficulties hinder the integration of energy measures in strengthening and restoration plans in the studied region. Based on our examination, we reflect on the possible use of the evaluation framework as a boundary object [5] We contribute to the literature on evaluation frameworks [6] in particular, we include lay values and liveability in our assessment of heritage evaluation [7], [8]. Lastly, we propose to expand the HEF to include assessment of energy measures.

2. LITERATURE REVIEW

2.1 INTRODUCTION

In this section, we outline a practice approach to valuation, based on ethical and Science & Technology (STS) literature. We discuss the Authorized Heritage Discourse compared to lay values. We also reflect on the incommensurability of values, which leads to the need to balance these values and make decisions and trade-offs. In Groningen, trade-offs have to be made between cultural history, safety and livability. Therefore, we briefly reflect on liveability in connection to heritage buildings and review the social scientific literature on the Groningen earthquakes, focusing on communication, risk perception and psychological effects.

2.2 VALUATION OF HERITAGE

Valuation of historical buildings basically involves three steps: identifying the features that are valuable, why they are valuable and how valuable they are [9]. However, valuation as a creative process entails a second important aspect, valorization, which refers to improvement, of making something (more) valuable [10]. Heuts and Mol identify 'registers' of valuing: bundles of criteria used by valuers, related to their interests and backgrounds. This concept helps to explain differences in value assessments between actors [11]. Furthermore, registers are related to the position of the actor with regard to the historical building; local historians, residents, and the mining company have very different registers for the valuation of buildings.

Values often conflict, they can also be incommensurable, thus accordance with one value can lead to damage to the other [6] [12]. Strengthening buildings for earthquake safety can seriously damage historical qualities. Even more strikingly, strengthening can inhibit the use of the building, which threatens livability and local identity. Energy measures can also threaten historical values of buildings in various ways [13]. Valuation is thus a balancing act which requires negotiations between involved stakeholders.

The heritage sector has developed a general language and specific criteria for value assessments, which is often referred to as the Authorised Heritage Discourse (AHD) [9], [14]. Valuation of historical buildings is usually performed

by cultural-historical experts, who have completed a special training in value assessment. Valuation by lay people and communities is studied by Parkinson et al., Mydland et al. and Van der Schoor et al. [7], [8], [15].

2.3 GAS-INDUCED EARTHQUAKES AND RISK PERCEPTION

Psychological investigations indicate that large groups of Groningen inhabitants experience psychological problems, such as depression, as a consequence of earthquake related problems [2]. In a study on public risk perception, Perlaviciute et al. reported an increase in perceived risks and negative emotions in the years following the first major earthquake in Groningen [16]. In particular, people reported a high risk to property and to the image of the region. Negative emotions increased, in particular feelings of powerlessness. Importantly, people did not find that mitigation measures to address these risks were well implemented [16]. Research findings suggest that the extent to which residents are able to cope with earthquake experiences determines their intention to leave the region [3].

There has been little research so far into gas-induced earthquake communication, however Opperhuizen et al. recently performed a media analysis. Most apparent in their sample of 2,265 relevant media reports were personalization, dramatization and negativity bias. They also conclude that the media did not perform its 'watchdog' function until 2013 [17].

2.4 LIVEABILITY AND SENSE OF PLACE

How does heritage connect to the concept of liveability? In this paper, we restrict ourselves to the contribution of heritage buildings to the perception of liveability. Already in 1981 'sense of identity' was identified as a key motivational force behind the desire for preservation [18]. English Heritage has taken up the concept of 'sense of place' in several publications and position papers, seeking to involve the needs and preferences of local communities in their work [19]. The framework for indicators of historic sustainability, as proposed by Stubbs, includes multiple social issues, such as civic pride and sense of place, social inclusion, referring to the ability of the historic environment to engender skills and improve self-esteem and community [20]. Stubbs also mentioned '*public understanding and awareness of the heritage sector and links to sustainability*' and '*appraisal of relevance of heritage sector to everyday lives*' as criteria in his framework [20].

Strange & Whitney indicate that community strategies, drawn up by local strategic partnerships, can be powerful tools for community engagement and regeneration. The principles suggested by Pickard also stress the connection of heritage with local life and community involvement [21].

3. METHODOLOGY

The empirical material on which this paper draws is assembled in the course of a case study of expert and public discourse regarding heritage and earthquakes. The case study is situated in the earthquake region of the province of Groningen. This part of our research in particular investigates the 'Heritage and Earthquake

Framework'. The HEF's most important task is to help local authorities with the assessment of proposals for the strengthening of heritage buildings for safety reasons. For the analysis of public discourse, we assembled websites from involved NGOs, media reports and activists' blogs, including material describing the reception of the HEF. Other relevant documents, such as policy papers and reports of stakeholder discussions served as control and backup. Furthermore, we visited meetings with experts and public in the region. Documents were imported in Atlas.ti and analyzed according to guidelines for qualitative research [22], [23].

Juxtaposing the discourses of experts on the one hand, and the lay public on the other, we aim to highlight differences in evaluation discourses. We rely on 'discourse analysis', which is concerned with the analysis of 'world-building' with texts [24]. We focus our analysis on three themes: cultural values, safety and livability.

4. CASE STUDY: HERITAGE, SAFETY AND LIVABILITY

4.1 GOVERNMENTAL APPROACH: HERITAGE AND EARTHQUAKES FRAMEWORK

Local authorities have an important task in evaluating plans for re-use, repair and strengthening of historical buildings. This is a formidable task, because of the staggering amount of heritage buildings damaged or threatened by earth-

		TABEL - WAARDEN VS. VERSTERKEN & MAATREGELEN										
		VERSTERKEN						GEBRUIK			SLOOP OPRUIMEN	SLOOP NIEUWBOUW
Invloed van versterken op de Waarden: heeft invloed op: Waarden:												
CULTUUR HISTORIE	Landschap											
	Stedenbouw											
	Archeologie											
	Gebouw											
	Interieur											
	Bouwhistone											
LEEFBAARHEID	Gebruik											
	Beleving Ruimtelijke structuur											
	Symbolische waarde											
VEILIGHEID	Veiligheid											
	Bouwsubstantie schadevrij											

Figure 1. Traffic-light table of Heritage and Earthquakes Framework.

quakes. In the ten municipalities there are over 1,800 listed buildings (national importance), more than 800 municipally listed buildings and 28 protected views.

The 'Heritage and Earthquakes Framework' (HEF) has been developed to assist local authorities with the assessment of repair and strengthening plans. It was commissioned by the RCE and is drawn up by a group of advisors on historical buildings and spatial planning. The HEF is focused on practical solutions for repairing earthquake damage and safety proofing and gives recommendations for a due process. This is especially important given the low level of trust in the institutions that were responsible for damage assessment and repair [16]. For example, until recently the mining company was heavily involved in both the assessment and repair plans of damaged buildings.

The HEF takes three lines of approach: cultural history, safety, and livability. The framework is summarized in a traffic-light table, which can assist with finding solutions that do justice to the three themes. A range of possible solutions is depicted in the first row, so the impact on the three dimensions can be quickly scanned.

4.2 CITIZEN'S RESPONSES

There is a range of citizens' organizations in the region, such as Groninger Gasberaad, Schokkend Groningen, Groninger Bodembeweging, and the VGME (Society of Owners of Listed buildings), which all work on policies, citizen support, information and events concerning earthquakes in the region. We examined a selection of blogs, op-ed articles and media-interviews, featuring representatives of the NGOs or concerned citizens. Furthermore, a special website to monitor disappeared buildings invites the public to contribute information and photographs and stories.² The aim is to provide a rich overview of how natural gas mining changes the landscape of Groningen. This database combines the findings of journalists with (verified) public contributions. To date, 92 buildings were reported demolished and 373 are threatened.

After the publication of the framework – which had been leaked to the press – many public voices concluded that heritage in Groningen was up for ruination. Discussions in social media about meetings on the strengthening operation also show the worries of citizens in the region regarding the character of the towns and villages, for example fearing that 'Towns in Groningen will turn into characterless suburbs'.

5. BALANCING CULTURAL VALUES, SAFETY AND LIVABILITY

5.1 THEME CULTURAL VALUES

The Heritage and Earthquake Framework has supplied examples, which show how values could be balanced in actual situations. Furthermore, the advisory report 'Levende monumenten in een leefbare regio' [25] (Living monuments in a livable region) includes four case studies of severely damaged historic buildings.

2) www.hetverdwenengroningen.nl

Citizens' organizations primarily refer to the 'character' of buildings in Groningen, which should in their view be protected. Furthermore, citizens use cynicism in discussing 'new Groninger' types. Citizens and their organizations not only argue, but increasingly act to force institutions to take identity and architectural character into account. Multiple strategies are used to reach this goal. Individuals act by drawing attention to demolition or other threats on social media. Citizens' organisations use various methods to inform and support members and communities. For example, in Overschild a local 'whitebook' was prepared to support residents with the strengthening procedure, and in Krewerd every home-owner in the village will be assisted by a specialized architect to ensure the outcome of the strengthening operation will carry support of the residents. It turns out to be very difficult to keep energy measures on the agenda in the often long and maze-like processes of assessment, strengthening and restoration planning. Furthermore, the financial structure apparently inhibits energy measures, because the mining company refuses to pay for such 'unnecessary' interventions.

5.2 THEME SAFETY

In general, the societal discourse on safety has a very high profile, anything can be forbidden 'in the interest of health and safety'. However, the scientific base of safety measures is contested in the HEF itself, for example when the authors mention that many variables are not yet sufficiently examined. This leads to the risk of 'overprotection', potentially causing severe damage to cultural-historical values. The report *Levende Monumenten* [25] prepared the way in this respect and advises that historic buildings should keep the exemptions they presently have with regard to building regulations. Especially since the knowledge base of historic buildings and earthquakes is incomplete.

The public is of course very much concerned with safety issues. This expresses itself often in pleas for the reduction of gas mining, to prevent earthquakes as far as possible. The Groninger Gasberaad strongly advises to stick to one version of the national safety protocol, which is regularly updated. Otherwise, decisions for comparable buildings in the same village, or even the same street, can turn out very differently. They also warn for an over-cautious safety policy and argue that care for history and character should be balanced with safety concerns.

5.3 THEME LIVABILITY

Livability is in this paper only regarded where it relates to heritage in the built environment, following the Heritage and Earthquake Framework (HEF). The authors of the HEF have to be commended for the sincere and extensive way they have included livability and use issues in the framework. They identify three issues: symbolic values, use and spatial 'readability'. The report *Levende Monumenten* [25] provides concrete suggestions for the inclusion of livability in the management of villages with threatened heritage buildings, such as the appointment of a town-manager to support local processes.

The public has sometimes very outspoken views on liveability. Protection of characteristic buildings sometimes leads to bodily protest methods, for example

a couple decided to squat the farm they wanted to buy in Middelstum, after the mining company repeatedly refused to take on their offer to buy it. A massive rush of solidarity with the couple emerged in regional news and social media, and ultimately the mining company relented.

6. DISCUSSION

The gas induced earthquakes in Groningen have a severe impact on heritage values in the earthquake region. Damage caused by these earthquakes is not incidental, it is expected to continue to occur in the coming decades. Furthermore, the proposed strengthening operation threatens even more historical buildings.

In this paper, we investigated how the Heritage and Earthquake Framework can assist with the assessment of proposals for 'earthquake-proofing' historical buildings. We focused on three aspects: cultural historical values, safety and livability, and in particular, how these aspects are balanced. Furthermore, we examined lay (public) responses on these three themes. We conclude that the HEF aims to balance cultural values with demands of safety and priorities regarding liveability. An extensive process is suggested to guide both owner and local authorities through the different steps of the assessment process. The question remains, however, if the HEF is successful as a 'boundary object' [5]. For example, it is unclear if the officials in charge of safety actually use this balanced approach in their decisions for the strengthening operation. At least, citizens' organisations repeatedly express doubts concerning aspects such as liveability and local character in strengthening plans. Furthermore, the regular update of the safety regulations creates fear for unequal handling of similar buildings. More in-depth research is needed to bring to light how cultural values, safety and liveability are balanced in the preparation of the strengthening plans.

Citizens' organisations strongly support the protection of local character of towns. They strongly argue that towns in Groningen should retain their historic identity and increasingly act to force institutions to take identity and architectural quality into account. Multiple strategies are used to reach this goal, on several levels. Individuals act by drawing attention to demolition or other threats on social media, or by taking personal action such as squatting.

Values concerning energy efficiency are especially important in this region, because many people see the damaging effects of mining fossil fuels in their direct environment. Hence the pleas to 'pair opportunities' of strengthening, restoration and energy neutrality. However, these opportunities are lost due to financial and procedural difficulties. Unfortunately, the framework fails to address energy interventions. Nonetheless, the HEF may form a strong methodological basis for integrating energy with cultural-historical and social values.

This paper gives only a preliminary account of the dynamic phenomenon of heritage protection in the earthquake region. Local authorities have so far been rather silent on the procedures regarding heritage under their governance. Gathering information about their views and experiences in this major operation is

one of the tasks for the next phase of our research project. More in-depth investigations are necessary to follow the struggles and strategies to conserve historical identity and heritage buildings in the towns and villages of Groningen.

Lastly, the methodology of the Heritage and Earthquakes Framework could be applied to assess measures for gas-free and energy neutral restoration, which would also improve chances of integrating energy measures in repair, strengthening and restoration plans.

7. REFERENCES

- [1] C. Howe *et al.*, "Paradoxical Infrastructures: Ruins, Retrofit, and Risk," *Sci. Technol. Hum. Values*, vol. 41, no. 3, pp. 547–565, 2015.
- [2] GGD Groningen and Rijksuniversiteit Groningen, "Aardbeving en Gezondheid 2016," Groningen, 2017.
- [3] S. J. T. Jansen, J. S. C. M. Hoekstra, and H. J. F. M. Boumeester, "The impact of earthquakes on the intention to move: Fight or flight?," *J. Environ. Psychol.*, vol. 54, pp. 38–49, 2017.
- [4] P. Meurs, E. Zuidema, and K. Holstein, "Afwegingskader Erfgoed en Aardbevingen," 2017.
- [5] S. L. Star and J. R. Griesemer, "Institutional ecology, translation and Boundary Objects, amateurs and professionals in Berkeley's museum of vertebrate zoology, 1907–39," *Soc. Stud. Sci.*, vol. 19, no. 3, pp. 387–420, 1989.
- [6] I. Van de Poel, "Values in engineering design," in *Handbook of the Philosophy of Science. Vol. 9: Philosophy of technology and engineering sciences*, A. Meijers, Ed. Elsevier B.V., 2009, pp. 973–1006.
- [7] A. Parkinson, M. Scott, and D. Redmond, "Competing discourses of built heritage: Lay values in Irish conservation planning," *Int. J. Herit. Stud.*, vol. 22, no. 3, pp. 261–273, 2016.
- [8] L. Mydland and W. Grahn, "Identifying heritage values in local communities," *Int. J. Herit. Stud.*, vol. 18, no. 6, pp. 564–587, 2012.
- [9] L. H. Fredheim and M. Khalaf, "The significance of values: heritage value typologies re-examined," *Int. J. Herit. Stud.*, vol. 22, no. 6, pp. 466–481, 2016.
- [10] F. Vatin, "Valuation as evaluating and valorizing," *Valuat. Stud.*, vol. 1, no. 1, pp. 31–50, 2013.
- [11] F. Heuts and A. Mol, "What is a good tomato? A case of valuing in practice," *Valuat. Stud.*, vol. 1, no. 2, pp. 125–146, 2013.
- [12] I. Van de Poel, "Design for values," in *Social responsibility and science in innovation economy*, P. Kawalec and R. P. Wierzchoslawski, Eds. Lublin: Learned Society of KUL & John Paul II Catholic University of Lublin, 2015, pp. 115–165.
- [13] H. L. S. Schellen M.H.L., "Monumenten isoleren: complex en lastig karwei," *Energ. +*, vol. 28, no. No. 3, p. 24, 2008.
- [14] J. Pendlebury, "Conservation values, the authorised heritage discourse and the conservation-planning assemblage," *Int. J. Herit. Stud.*, vol. 19, no. 7, pp. 709–727, 2013.
- [15] T. Van Der Schoor, E. Colmenero-Acevedo, and M. Vieveen, "Valuation of medieval churches, taking account of laypersons' views (submitted)," *Restor. Build. Monum.*, 2018.

- [16] G. Perlaviciute, L. Steg, E. J. Hoekstra, and L. Vrieling, "Perceived risks, emotions, and policy preferences: A longitudinal survey among the local population on gas quakes in the Netherlands," *Energy Res. Soc. Sci.*, vol. 29, no. April, pp. 1–11, 2017.
- [17] A. E. Opperhuizen, K. Schouten, and E. H. Klijn, "Framing a Conflict! How Media Report on Earthquake Risks Caused by Gas Drilling," *Journal. Stud.*, vol. 0, no. 0, pp. 1–21, 2018.
- [18] D. Lowenthal and M. Binney, *Our past before us: why do we save it?* London: Temple Smith, 1981.
- [19] English heritage, "Conservation Principles, Policies and Guidance," 2008.
- [20] M. Stubbs, "Heritage-sustainability: developing a methodology for the sustainable appraisal of the historic environment," *Planning, Pract. Res.*, vol. 19, no. 3, pp. 285–305, 2004.
- [21] I. Strange and D. Whitney, "The changing roles and purposes of heritage conservation in the UK," *Plan. Pract. Res.*, vol. 18, no. 2–3, pp. 219–229, 2003.
- [22] R. Yin, *Case study research: Design and methods*. Beverly Hills: CA: Sage publishing, 1994.
- [23] J. W. Creswell, *Research Design: Qualitative, Quantitative and Mixed Method Approaches*. 2007.
- [24] J. P. Gee, *An introduction to discourse analysis: theory and method*, 2d ed. Routledge, 2005.
- [25] K. De Graaf, R. Hendriks, and E. Zuidema, "Advies Levende monumenten in een leefbare regio," Groningen, 2015.

Nearly Zero Energy Heritage

Taboo or challenge?

G. Franco

*Department of Architecture and Design, University of Genoa, (DAD), Genoa, Italy.
Email: francog@arch.unige.it*

Abstract – Architectural heritage has been considered as one of highest peaks of Italian culture and its universities as a point of excellence in conservation and restoration. However, they have not been able to fully address contemporary challenges, responding to demands of energy saving and raising of comfort levels. The achievement of NZEB standards in historic buildings, especially those protected by the Ministry of Cultural Heritage, is still considered taboo – if not a dangerous technical drift.

An ongoing project on an 18th Century small listed building is animated by a different spirit; here the traditional conservative approach has been integrated with specialists in energy efficiency. The proposed contribution aims to present an example striving to become indicative of best practice, while highlighting in particular the conflicts concerning material conservation, enhancement of cultural significance and needs for new use, as well as the possibility to overcome some cultural barriers through creativity and innovation.

Keywords – NZEB; cultural heritage; values; energy efficiency; conservation

1. INTRODUCTION

The concerted drive on the part of the Italian government to encourage recourse to energy efficiency measures in building restoration, also with a view to achieving “Nearly Zero Energy Buildings” standards, bestows upon scientific research and technology a fundamental role, especially with regard to cultural and historical heritage. The most advanced dedicated study and experimental field finds itself faced with the double commitment of predisposing and adapting procedures, analysis methods and restoration more suited to the construction and architectural features of historical buildings and to make the actual achieving of virtuous examples possible.

The juxtaposing of the terms “energy efficiency” and “preservation”, to date somewhat distant from each other in the Italian context, must not, nonetheless, be considered as a mere exercise in technical application. Nor are they mere exclusive technological transfer; rather, they stand for the triggering in a slow process of cultural advancing, which requires considerable synergic commitment.

Supported by various financing channels, the culture of Italian architecture heavily involved in restoration and preservation of the country’s historical monument heritage has been set objectives over the past few years which, traditionally, did not belong to its specific sphere of interest [1]. With a co-ordinating role of

multidisciplinary working groups, both organizations appointed to safeguard, and experts in the field of architectural restoration, have intensified study initiatives. The aim has been to draw up guidelines [2] and inform and communicate on their own research activities [3] so as to make other players aware – these latter still somewhat sceptical with regard to such issues.

Over and above scientific studies respecting the *diktat* of their sectorial character, the demand felt today is the opportunity to refer to *best practice* [4]; such may make attitudes and technical methods employed in the field explicit, if the purpose is to improve the thermal behaviour of the historic building and to implement renewable energy sources (which until only a matter of years ago were considered veritable taboos in a restoration project). Various are the players this awareness-making process may be addressed to:

- Owners, be they public (or religious) or private organizations, often oblivious to the most recent scientific issues but interested in “sustainable” management (also financially) of the heritage they are responsible for, as well as the possibility to access financing in the form of incentives and fiscal relief;
- Technicians and professionals. These two categories may, for example, be compelled to undertake permanent professional training programmes offered by dedicated recognized organizations;
- Superintendence officials representing the authorities appointed to evaluate and approve proposed projects on the basis of tried and tested preservation practices.

The opportunity to introduce energy efficiency measures in historic heritage (already completed or in the process of completion) can be an essential basis for convincing owners to invest more in similar intervention. At the same time, the diffusion of case studies could raise awareness among Italian protection organizations so they can authorize technical operations such as insulation and solar panel insertion, without compromising protection and safeguarding of historical material characteristics in buildings dating back to the past. The case study here presented can serve to make owners and technicians aware on several counts: the building is private and listed, with all intervention requiring the approval of the Municipality and the Regional Superintendence of Archaeologies, Fine Arts and Landscape. This case is particularly significant from the point of view of design and decision making process, since energy improvement – not mandatory by regulation – is part and parcel of the restoration and reuse project.

2. A PRACTICALLY ZERO ENERGY RESTORATION PROJECT

The very effort to show a practical case study and not only a theoretical example, is one of the basic aims of a restoration and reuse project for a small historical

1 Up to 65 percent of the total cost of insulation and improvement of glazing systems (for a total amount less than 100.000,00 Euros) from the Ministry of Economic Development.

building boasting unique architectural features and recognized as a listed building protected by the Superintendence of Archaeologies, Fine Arts and Landscape.² It is a building of which the history remains scarcely known, even though it occupies a most central position in the city. The property of the Genoese Municipality from 1889 to 2004, it was then purchased by a private concern, which was fully aware of how unique the building and acquisition were. The purchaser then determined to programme a lengthy process (ongoing) of restoration and reuse, including energy enhancement, tending towards the excellent.

The first and foremost purpose of the operation is to instil new life into the building by way of a reuse and preservation project focusing on overcoming the state of abandon the building had been wallowing in for several years, restoring dignity and value to an important urban episode, unveiling its hidden history and opening some parts to the public – in forms and ways compatible with its being private property. Despite the new function, residential (a flat) and offices of a professional activity, the idea came about that it should become an experimental laboratory for processes and technologies for energy saving and seismic improvement – possibly satisfying Nearly Zero Energy Building standards for existing buildings in climatic zone D (Table 1). This approach is quite a novelty since for this type of building it is not required to satisfy technical standards.

Table 1. Italian Zero Energy Building definition for existing residential buildings (2019-2021)

Thermal transmittance U (W/m ² K)					
Ground floor	External wall	Roof structure	Maximum primary energy [kWh/m ² y]	Share of RES for energy production	Electric energy from PV (kW)
0.29	0.29	0.26	30	50 % (Thermal)	2

In itself the idea embodies more than one challenge:

- the contrast between the features of the historical building, never employed for residential purposes, and the demands of inhabiting in terms of comfort and energy saving;
- the willingness to modify in the least measure possible the material nature of the construction, despite having to insert new installations and equipment;
- the possibility to create a round table comprising different specialists, not always in complete agreement on the same objectives of safeguarding and preservation of existing values both material and immaterial;
- the “sustainability” target of the whole operation from the social, cultural, economic and environmental points of view.

² The building avails of monument protection status and it must remain open to the public in the basement area and the roof terrace, with a landscape protection order on the adjacent garden and on its archaeologically precarious nature – it stands on an area featuring several historical stratifications.

Hence, the interest motives in this initiative are different. Not least of all, the most repetitive nature of going round and round a long process to be subject *in itinere* to quality checking – similar to the logic of industry.

3. ARCHITECTURAL FEATURES AND HISTORICAL VALUES

The building stands in the centre of the city in an area which over these past two centuries has undergone numerous transformations. Tradition has it that it dates back to 1825, but in reality the sisters of Saint Martha had it built on their land probably at the end of the eighteenth century with a view to using it as a “belvedere”. Evidently the attraction was the building’s spiral staircase in a cylindrical tower on the corner, leading to a flat terrace from which you can enjoy a totally unique 360° view.³ The building, which is situated in grounds rising above the present level of the access-yielding street, boasts trapezoidal design and three floors above street level and one floor partially a basement. The dimensions as they appear on the building plan are rather unassuming; originally there was merely one room per floor, looking out through large arch openings, devoid of shutters so as to enjoy the view as from a loggia. The vertical structures are stone load-bearing walls.⁴ Horizontal edifice shows brick vaults in pavilion shape with lunettes except for the roof terrace – demolished after World War II and rebuilt in reinforced concrete (Figure 1).

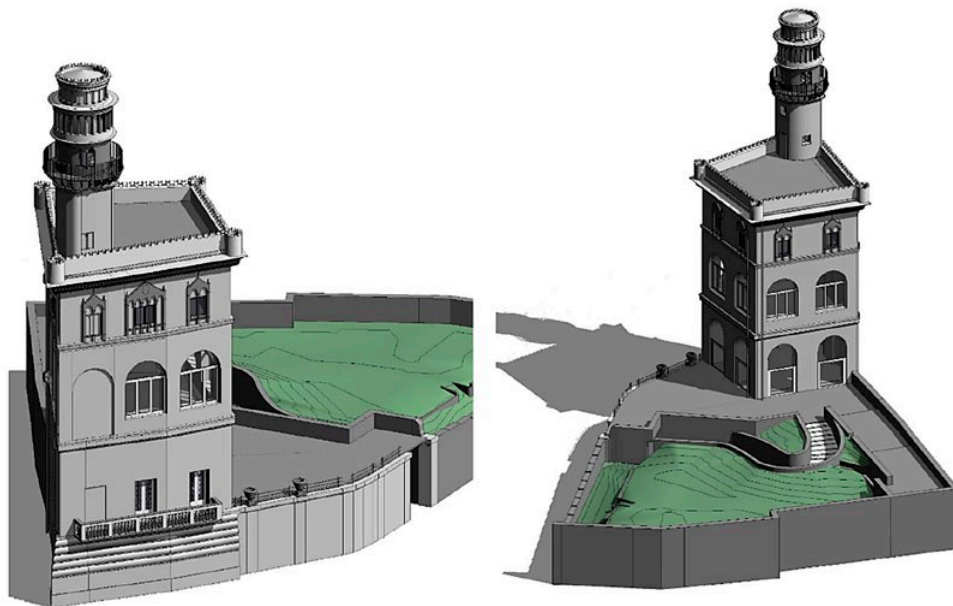

Figure 1. BIM Model of the building (west and east façades).

- 3 The historical information prior to sale of the building was summarily detailed; lengthy archives research carried out by Santamaria of the State Archives Genoa has led to the revealing of a hitherto unknown history.
- 4 A sturdy wall of Middle Ages building characteristics allows us to suppose that the building was erected around some already existent constructions belonging to the city’s very first fortifications. Such a hypothesis is also substantiated by chemical analysis completed on mortar samples removed pursuant to wall coring.

The study on the history of the building and its transformation, especially after the Second World War, was particularly important. It highlights which parts are original, which were added to change the image in keeping with the taste of the time and which are fairly new (1973–1978). The last certainly bear less historical legacy and material value and are, thus, suitable for intervention comprising major modifications.

The first major transformation took place in 1821, when the mayor of that time purchased the property for his own leisure and called upon the municipality architect Carlo Barabino as well as Michele Canzio, the expert scenographer and decorator, to change the external appearance – but not the structure – after a neo-Gothic style. In 1889 the heirs of Marchese Serra sold all his property, including the enormous garden, to the local municipality. Bombing during World War II heavily damaged the roof – later to be replaced by a hollow-core concrete structure – and the outer plastering. Neglect and total abandon, as well as acts of vandalism and squatting, reduced the property to such a deplorable state that in 1973 the municipality commissioned to have the property restored. In keeping with the culture of the era, restoration was of a distinctly reshaping nature: complete external and internal re-plastering with concrete mortar and heavy steel reinforcement in at least one of the two vaulted areas. In 1978 further internal renovations were effected so as to house a small museum, with extensive use of reinforced concrete structures, somewhat detrimental to any attempt to detect seventeenth/eighteenth century origins.

In short, such was the state of affairs at time of building abalienation. The quasi-total absence of documentary material and the evident incomplete unreliable nature of the existing survey encouraged the owner to invest (time and finances) into a long period of analysis and familiarizing. Indeed, this is necessary both to fill a void in urban historiography and to orient and direct the project of reuse, restoration and energy improvement based on the difficult search for a balance between new needs and preservation of the meanings and material values of what the building had been before.

4. INQUIRY THROUGH MULTIDISCIPLINARY COMPETENCES

Given that the bibliographical information was rather summarily reported and in some points contradictory, a private/public archive-oriented inquiry was launched, as well as a concurrent drive to obtain surveys of the building and annexed garden, using different methods (topographic, tape-measured, digital plane photogrammetric, PhotoScan). The superimposition of photo-planes of the prospects with iconographic (1823) and photographic (1926) representations has allowed “reading”, albeit virtual, of the rich decorative apparatus, irremediably deteriorated by neglect and damaged during war bombing (1973) (Figure 2). Despite the absence of original plaster, completely replaced after 1973, the hypothesis of insulating the building from the outside was excluded from the beginning – such a type of intervention being in stark contrast with preservation criteria.

In order to substantiate some hypotheses on developmental stages emerging from archives enquiries (reference is to walls predating the eighteenth century,

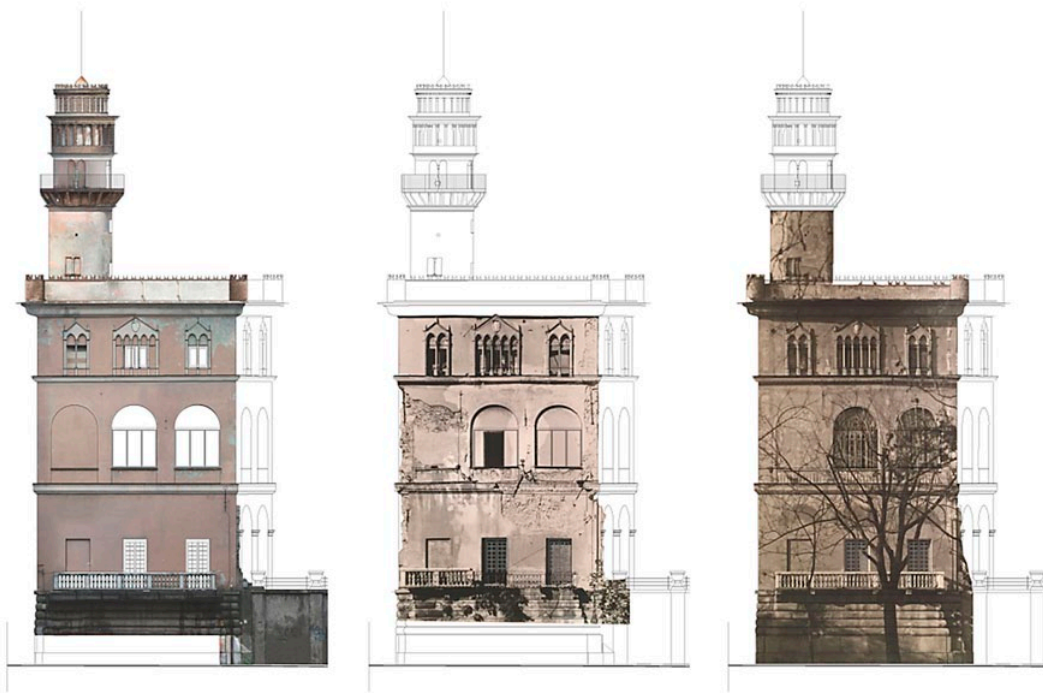

Figure 2. Different constructive phases, external plaster and openings: 2006, 1973, 1926.

the era in which the building was erected, and to the dating of wall and vault creation) a series of tests both archaeological (foundations) and architectural (sample takings of plaster at delicate points submitted for chemical analysis so as to date them) have been carried out, thus comparing direct and indirect sources. Along with testing and digging, there has also been coring, vertical perforations to verify the nature and substance of the ground around the building. Indeed, an early idea shared by owner and technicians alike comprised the option of recurring to geothermal energy to satisfy thermal and electrical needs.

Table 2. Thermal transmittance of the building envelope – current state

U (W/m ² K)				
Ground floor	External Wall ground floor	External wall first floor	External wall second floor	Roof structure
1.26	1.45	1.65	1.72	1.12

Table 3. Surface and volume – current energy demand

Total surface S m ²	393
Volume V m ³	2150
Envelope surface S_{env}	1280
Surface /Volume	0.59
Current Global Energy Performance Ep_{gl}	380.25 kWh/m ² y
Current Envelope Energy Performance Ep_{env}	230.45 kWh/m ² y

Since the building has not been used for almost ten years, no environment-oriented monitoring has been applied, nor has it been possible to examine real energy consumption to evaluate thermal behaviour. Materials and stratigraphy of elements allowing heat to disperse have been identified (floor covering, external walls, windows, roofing) to evaluate its related thermal transmittance (Table 2). In keeping with Liguria Regional Law n. 22 (29/05/2007), national Law D Lgs n. 102/2014 and European Directive 2010/31/EU (Table 3), the global energy performance and the energy performance for the envelope indices have been estimated in the current state and before any improvement.

5. ENERGY STRATEGIES: GOALS AND TECHNIQUES

Right from project beginning the owner had expressed the intention to respect the NZEB standards with a global energy performance forecast of around 30 kWh/m²y. He sought to involve all interested professional parties in the preliminary design process and invited them to make also the architects from the Superintendence aware of such goals.

To satisfy the demand for renewable sources, a geothermal heat pump, applicability of which had been previously verified with archaeological essay and vertical coring in the soil, will produce thermal and electrical energy. The latter exceeds the required quota of 50 % (Table 1) and reduces CO₂ emissions to 5 kg/m²y (compared to an estimate which could be around 150–200 kg/m²y in the current state). This technology certainly impacts less on the existing buildings – if compared to solar energy powered panels, which are often incompatible with the preservation of architectural features. A small surface of pavement photovoltaic panels, respecting regulation requirements, could be installed on the flat roof terrace – hidden from view. Since the application of this technology on historic buildings is a controversial issue, it will be necessary to set out by verifying the attitude of the interested safeguarding organs. In any case, historical and archival analysis has revealed that the re-construction of the flat roof in reinforced concrete dates back to 1973; none of this particular part of the construction, unfortunately, had been spared WWII bombing. A heat pump will power floor radiant panel heating; this intervention previews the removal of flooring and subfloor – both renewed in 1973 and not original. A mechanically driven ventilation installation to check inside comfort conditions (relevant humidity, overheating) and domotics installation to check inside comfort (plants and dimming of windows) have also been previewed. Another criterion shared by the project group, as well as by the client, is the minimum interference between new channelling and the new vertical and horizontal wall structures, entrusting to the new dividing walls (conceived with “dry-stone wall” technologies) the role of net restraint. Vertical passages will be reduced to a minimum number, examining a technical “loop”, required for the installation of a new lift.⁵

⁵ The lift will be installed in a type of wall-surrounded cavity and hence will not be visible on the ground floor, where the single vaulted area will remain completely empty – as it was originally.

The horizontal flat structures (floor and ceiling) remain within the limits of transmittance laid down by regulations (previewed U-values equal to $0.20 \text{ W/m}^2\text{K}$): the interspace between ground floor slab and soil, completed in 1973, will be filled with mineral insulation material while the flat terrace structure, in a poor state of preservation and devoid of historical architectural value, will be demolished and rebuilt with a light insulated steel structure. Windows and external opening will be replaced: the existing ones were added after 1973, hence lacking in any documentary historical value as well as proving to be quite ineffective, while the new ones will have low-emissive double-glazing, respecting the minimum requirements of technical legislation (even lower, between 1.2 and $1.4 \text{ W/m}^2\text{K}$).

Despite efforts made regarding maximum enhancement and preservation of material authenticity, there emerge some conflicts evidently opposing demands, especially in applying of internal wall and brick vault insulation. The external walls and the brick vaults of the ground and first floors were, in fact, built in the 18th century, as is evident from historical archival examination: the bearing structure in irregular stone is still original, while the cement plaster finishing outside and inside are completely new (reconstruction in 1973). Another constraint of a material nature (the choice being the client's) concerns the type of insulation to be used. To adapt to the material characteristics of the historical construction (stone, brick and lime mortar) it is preferred to use compatible materials of the same mineral origin (insulating panels based on calcium silicate hydrates or lime-based thermo-plaster with cellular glass aggregates to replace internal cement plaster dating back to 1973), even though their thermal performance is less efficient than synthetic insulators (expected external wall U-values between 0.36 and $0.41 \text{ W/m}^2\text{K}$, counterbalanced by the low U-values of windows and flat floors). To insulate the vaults and solve existing thermal bridges, a double system will be used: passive (inserting mineral insulation in the empty space between the extrados of the vaults and the wall) and active (in the form of heating supplying resistance above the vault cornice).

6. CONCLUSIONS

The experience conducted to date with this small project of reuse and restoration is by no means devoid of the complex problems which must be faced when working on the historical heritage, but it is significant for the fixing of the procedure and involvement of all interested parties. The latter include the architect and archaeologist working in the Superintendence and in charge of the authorization process. From the first design phase and decision making process, what can be underlined as a meaningful approach is a logic of "compensation" and "balancing" concerning different values (restoration and NZEB standards *in primis*), which also means striking a balance between conservation and transformation. Original materials, elements and architectural forms, which have been afforded a historical and "witness" value, will be preserved and appreciated; recent construction elements (1973–1978), mainly in concrete and reinforced concrete, will be replaced with more compatible and, in thermal terms, even more efficient, enhancement materials. The creative attitude typical of the architectural

design process will also involve technical equipment (i.e. PV floor) in co-operation with thermal engineering.

Other in-depth considerations will follow this first project phase, especially in the choice of the most appropriate materials and technologies, with not only financial but also environmental evaluation assessment. Indispensable will be both the phases of executive planning and delivery, which should feature a highly qualified workforce. Nevertheless, the real success of this intervention cannot be decreed before complete execution and verification by way of annual monitoring during ensuing management stage.

7. ACKNOWLEDGMENTS

Topographic and longimetric survey: Enrico Tassistro, Marco Campi, Terramap; Photogrammetric survey, 3D modelling BIM, GIS: Alessandro Baiardi, Simonetta Acacia, Marta Casanova; Archival and historical analysis: Roberto Santamaria, Archivio di Stato di Genova; Preliminary diagnosis project: Alessandro Braghieri; Archaeological essays: Chiara Davite, Archiéo srl; Stratigraphy and essays: Sara Martini, Patrizia Bianchi; Chemical analysis: Sonia Mugnaini, Scienza per l'arte; Structural consultancy: Federico Martignone; Architectural design: Nicola Sarti; Energy Efficiency consultancy: Carlo Serrati, Ri-Aleph srls.

8. REFERENCES

- [1] E. Lucchi and V. Pracchi (Eds). *Efficienza energetica e patrimonio costruito. La sfida del miglioramento energetico nell'edilizia storica*. Milano: Maggioli editore, 2013.
- [2] Ministero per i Beni e le attività Culturali e del Turismo (2015). *Linee di indirizzo per il miglioramento dell'efficienza energetica nel patrimonio culturale*. [Online]. Available: http://www.beap.beniculturali.it/opencms/multimedia/BASAE/documents/2015/10/27/1445954374955_Linee_indirizzo_miglioramento_efficienza_energetica_nel_patrimonio_culturale.pdf [Nov. 30, 2015].
- [3] G. Franco and A. Magrini. *Historical Buildings and Energy*. Cham: Springer, 2017.
- [4] V. Hartman, M. Kirac and M. Scalet (Eds.). *Energy Efficiency and Energy Management in Cultural Heritage. Case studies Guidebook*, Venice: UNESCO, 2013 [Online]. Available: <http://renforus.net> [Nov. 1, 2014].

Energy efficiency improvement in historic urban environments

From decision support systems to co-creation strategies

Egusquiza, J.L. Izkara and A. Gandini

Sustainable Construction Division, Tecnalia, Derio, Spain. Email: aitziber.egusquiza@tecnalia.com; joseluis.izkara@tecnalia.com; alessandra.gandini@tecnalia.com

Abstract – Urban strategies addressing affordable improvement of citizens' comfort, fight against fuel poverty and better housing, have been proved to be important to keep historic cities inhabited and cultural values alive. Urban scale energy retrofitting requires flexible methodologies that facilitate evidence based decision making for policy makers and practitioners. Working in this direction, EFFESUS developed an incremental decision support system which works with different levels of information and offers energy strategies which are suitable for a wide range of historic urban environments. However, the universality of the approach did not consider the socioeconomic dynamics that can be triggered when a more local and systemic approach is adopted. Understanding the historic city as a unique ecosystem, nonlinear dynamics and evolutionary development can be used as leverage to unlock latent local capacities and activate the territory. Innovative eco-renovation strategies for traditional energy conservation measures from a life cycle perspective, are ways to work with local produced solutions linked with new local business models. ENERPAT is testing this approach. Three living labs have been created in Porto, Vitoria and Cahors as demonstration buildings and long-term thinking frameworks including stakeholders of the whole value chain. The solutions based on local materials that are being monitored have been decided by co-creation strategies using multicriteria methodologies, including criteria as social acceptance, socioeconomic development and circular economy. In this paper, EFFESUS and ENERPAT approaches and implementations are described and compared from different perspectives: multi-scalarity, 3D city models use, multicriteria methodologies, life cycle assessment, required information, stakeholders' involvement and expected impact. The analysis shows the complementarity of the outcomes and frames their use in different phases of the decision-making process to support the development of inclusive and sustainable strategies that can boost local economies.

Keywords – historic cities, co-creation strategies, life cycle assessment, stakeholder involvement, systemic approach

1. INTRODUCTION

Urban strategies addressing affordable improvement of the citizens' comfort, fight against fuel poverty and better housing, have been proved to be important to keep historic cities inhabited and preserved [1]. Urban conservation is also fundamental for the global sustainability as it maximizes the use of existing materials

and infrastructure, reduces waste, and preserves the historic character [2]. The process of updating our built heritage faces the complex challenge of balancing the requirements of the need of upgrading to the current standards of liveability and sustainability with the needs and constraints of the preservation of its integrity and cultural values.

The project EFFESUS (**E**nergy **E**fficiency for **EU** Historic Districts' **S**ustainability) addressed this challenge through a data driven approach based on a decision support system and multiscale data models, as the growing complexity and heterogeneity of the existing urban information make proper information management crucial for the comprehensive sustainable rehabilitation processes [3]. The EFFESUS approach had clear benefits: incremental decision making, cost effective data management, applicability in a wide range of European cities and evidence based decision making. But one of its limitations was that it did not consider the socioeconomic dynamics that can be triggered when a more local and systemic approach is adopted.

The historical landscape is the complex result of changes in the use and development of the city [4]. Historic cities are the product of evolutionary self-organization processes articulated around their territorial, environmental and climate context in the beginning and around their built environment at a later stage. Traditional cities have been considered as complex systems since the sixties [5] [6], as ecosystems where living entities (for example citizens, associations, business, local government) interact amongst them and with the buildings and infrastructures through information, energy and material flows, human connections and business dynamics. These interactions modify the structure of this ecosystem and the physical structure that supports the system (built environment and infrastructures). Some of these changes, steadily, make the historic urban areas learn and evolve through the adaptation to new circumstances and challenges making them complex adaptive systems (CAS). A CAS is characterized by spatial heterogeneity, non-linearity, multi-scale interactions and co-evolution, and the capacity to self-adjust as response to changes [7][8]. The preservation of our built heritage in this framework cannot be a passive process, but rather a process of evolutionary improvement of historic urban systems [9]. The historic areas should continue the process of adaptation and improvement that has allowed survival through the time, since it's their adaptability that ensures their sustainability [10].

Energy improvement in historic urban areas can be understood as one of these adaptive processes, where different operating agents (such as owners, tenants, architects, local government) try to update the building environment to more modern standards for different reasons: to improve comfort, to fight against fuel poverty, to reduce the energy bill or climate change mitigation. This improvement is usually studied as a disconnected and a linear process, neglecting its functional complexity and unpredictability. The conventional process is frequently initiated by the local government trying to improve the livability of their historic centers, attract new population or prevent depopulation. The historic built environment is then transformed to improve its energy performance and sustainability and the

results are monitored and assessed. However, other non-linear effects are not evaluated: the material and energy flows of the city have changed, the real estate dynamic is altered (the value of buildings can be increased, but gentrification processes can be triggered too), investment can be attracted to the historic area, local economies can be boosted (if local solutions are used), surrounding territory can be activated (if local materials are chosen), cultural identity can be preserved, and high value jobs can be created. These non-predicted effects are combined properties that are more than the sum of the characteristics of individual system elements. This is one of the characteristics of complex systems known as “emergence”. But how we can design a decision-making process to benefit of this emergence, when the outcomes cannot be totally controlled and the results of the interventions are unpredictable? Or as Marshall states “*The paradoxical challenge of planning then becomes one of how to ‘plan’ a kind of complexity that seems to have arisen ‘naturally’ in traditional cities, without planning*” [11]. One of the possible responses to this challenge is the participative, collaborative and iterative approach to engage urban agents in a process more similar to evolution than to design [12]. The optimization of complex environments needs bottom-up feedback and local knowledge is only available to the agents on the ground [13]. This is especially relevant in the improvement of the sustainability of the historic areas and buildings as local materials, climate, techniques and values are essential inputs. The ENERPAT project (Co-creation of Energetically efficient territorial solutions of Patrimonial Residential habitat Ecorenovation in SUDOE historical centres) is testing an approach where eco-renovation strategies that develop traditional energy conservation measures from a life cycle perspective, are a way to work with local produced solutions linked with new local business models. Three living labs have been created in Vitoria (Spain), Cahors (France) and Porto (Portugal) as demonstration buildings and long-term thinking frameworks, including stakeholders of the whole value chain.

In the next sections, EFFESUS and ENERPAT approaches and implementations are described and compared from different perspectives: multi-scalarity and 3D city models use, considered indicators, life cycle assessment, required information, stakeholders’ involvement and expected impact. The analysis shows the complementarity of the outcomes and frames their use in different phases of the decision-making process to support the development of inclusive and sustainable strategies that can boost local economies.

2. FROM A DATA DRIVEN APPROACH TO SYSTEMIC ECO-RENOVATION

Historic urban environments are not going to be strange to the key environmental and socio-economic drivers of change over the next 30 years: climate change, rising energy prices, social inclusion, information technology, global competitiveness, resource scarcity, changing patterns of consumption and demographics, insufficient or inappropriate built environments, and outdated or ill-adapted systems of planning, management and operational practice, among others [14]. They are going to have to face these challenges through rehabilitation strategies that must be respectful to their cultural values, but also coherent and compatible with their technological, architectural and constructive characteristics.

EFFESUS was a four-year research project funded by the European Commission under its Seventh Framework Programme investigating the energy efficiency of European historic urban districts and developing technologies and systems for its improvement. The project, with 23 partners and 7 case studies, developed a Decision Support System (DSS) as an ecosystem of tools and methodologies to support evidence based diagnosis and decision making. Part of this ecosystem was a data model, two software tools and a methodology that supports the selection and prioritization of energy efficiency strategies. The multiscale data model is the EFFESUS model: a 3D georeferenced model based on the standard CityGML, which uses the extensibility of the standard to develop the previously identified four specific domain extensions (energy, cultural heritage, indicators and dynamic extensions) in order to provide all information requirements regarding the historic city (a detailed description of the model can be found in [1]). In order to facilitate the implementation of a modelling strategy, a categorization tool was created. This web application uses information from the multiscale data model to perform a categorization of the building stock and support the selection of sample buildings (a detailed description of the categorisation methodology and web application can be found in [15]). Santiago de Compostela (Spain) and Visby (Sweden) were selected for the full implementation and validation of the DSS.

ENERPAT, partially funded by the INTERREG SUDOE program, is a 3-year ongoing project that addresses the challenge of finding energetically efficient solutions for the historic urban areas from the perspective of systemic eco-renovation and local techniques, considering Life Cycle Assessment (LCA), circular economy and co-creation perspectives. In the core of the approach is the idea that the improvement of energy efficiency and comfort can function as a central piece of the ecosystem of complex interactions between social, technical, ecological and economic forces. The eco-renovation approach from ENERPAT relies on a systemic innovation as the European Commission describes it: *“innovation that aims at responding to a societal challenge by obtaining a system-wide transformation through affecting the system’s economic, social and environmental dimensions as well as their interconnections”* [16]. Through innovating in local solutions and using local materials, ENERPAT aims to activate the surrounding territory, mobilize resources (materials) and local competences and capacities.

The evolution from the EFFESUS to the ENERPAT approach, is the expansion from a concept that considers material, energy and information flows to one that includes the former, but also takes into account more political, physical and social processes. The change sought in EFFESUS is a crucial one but limited sectorally (to improve the energy efficiency and living conditions to keep the historic city conserved and alive). ENERPAT aims for a more ambitious transition where the building retrofitting system of the historic city is transformed to a more sustainable, resilient and economically dynamic one (through the co-creation of innovative eco-rehabilitation solutions that are sustainable from the whole life cycle perspective and are based in local material and techniques to boost new local business models).

3. DECISION MAKING PROCESS: DSS VS. LIVING LABS

The end user of the EFFESUS DSS is an expert, working for the local government, who uses the tool to select the best energy retrofitting strategies for a specific historic city. In order to optimise the available data, different levels of decision making (LoDM) are possible within the tool. These LoDMs range from low levels (LoDM 0 and I) where only general information regarding the city is necessary and just generic strategies are provided, to medium-high levels (LoDM II and III) where the development of an external data model is necessary to structure the information and provide tailored strategies. The two highest levels can be considered as part of an incremental strategy of use of information: LoDM II addresses the agile generation of a basic functional model and LoDM III operates with a fully complete model.

ENERPAT uses co-creation strategies to decide the solutions that would be tested in the living-labs. The process of co-creation was originally conceived as a business strategy for identifying new forms of customer engagement and has since been applied to urban management to interact with citizens and stakeholders as a way of “creating new solutions, with people, not for them”. In urban contexts, the concept has evolved to address the socio-technological transition and the experimentation to develop new solutions to answer the complex challenges that cities face (e.g. sustainability, climate change or resilience). The type of living lab developed in ENERPAT has features of the “*Urban living labs*”, focused on specific urban contexts and problems. Central to this concept is the “*transition arena*” that offers an informal, well-structured space to a small group of diverse stakeholders or “*change-agents*” [17]. In ENERPAT the transition arena has been decided locally and included the whole value chain: local government, research organisations, practitioners, craftsman and construction workers and local solutions providers. This group of change-agents worked in different workshops to select the best solutions to be tested in the living labs. Local universities, closely connected with the historic cities, provide scientific background, they test the solutions in laboratory before the installation in the demonstration buildings and monitor and evaluate the results.

The different decision-making processes developed in both projects represent the differences between the principles of traditional modernist urban planning and the self-organization as it is described by Rantanen & Joutsiniemi [18]. The EFFESUS decision making process is set to look for mono-functional, techno-structural solutions using partial optimization strategies where the improvement of energy efficiency is considered as a separate activity in the process of organizing the city efficiently. Instead, the ENERPAT process uses the interlocking and overlapping of spaces to enable stakeholders to interact and evolve using a holistic rather than comprehensive approach trying to change the whole rehabilitation system.

4. CRITERIA AND SOLUTIONS

Three main axes that influence the historic cities energy sustainability were considered in EFFESUS: efficient resource management, liveability improvement and

conservation of cultural values. The followings six criteria were identified: indoor environmental conditions, embodied energy, operational energy, economic return, impact in heritage significance, and fabric compatibility. The DSS calculated quantitatively the impact in operational energy of each strategy and considered qualitatively indoor environmental conditions improvement, embodied energy of the solution, and the required degree of economic investment. An Analytical Hierarchical Process (AHP) was used to introduce the end user preferences in the system. The impact on the heritage significance was used as filter to discard solutions [19]. DSS automatically prioritised solutions from a database of 77 energy conservation measures previously characterized by experts.

In ENERPAT the solutions were not selected, instead they were created. Criteria and indicators were used to make stakeholders think about the different qualities of the possible solutions and to discriminate the ones not aligned with the project goals in order to focus the discussion on a short list of solutions. To the criteria proposed by EFFESUS, energy poverty, logistical easiness, socio-economic development, and citizen acceptance were added. The LCA was broadened (and focused), specifically including the proximity of the materials and circular economy concepts. The final solutions were selected in each living lab by consensus based on the local materials and solutions suitable to be improved and local business models developed. The solutions were basically focused on the improvement of the building envelope using locally available materials and the involvement of local business interested in developing innovation around them, for example the use of hemp mixed with lime in Cahors or cork in Porto. Currently, the baseline of the energy performance and comfort is being monitored in the demonstrator cases and a separate LCA assessment is being carried out to compare the sustainability of the original rehabilitation system (“business as usual”) with the proposed new one.

5. REQUIRED INFORMATION, MULTI-SCALARITY AND 3D CITY MODELS

The urban interventions in valuable and vulnerable environments such as historic districts must be carefully planned and managed to ensure that the new interventions are respectful with the heritage values in all the scales. A multiscale approach that considers the multiscale of energy and heritage significance, makes it possible to develop location-specific heritage significance impact assessment, i.e. to systematically link the impact of one solution with the heritage value of the specific element that is impacted. Then, interventions that were initially considered unacceptable at the building scale could be considered suitable at the component scale [1].

Both projects have in common a multiscale data model based on the standard CityGML that aims to be the reference model for the diagnosis, decision making and management of the energy efficiency in historic urban areas, integrating energy and cultural heritage information. Both projects used the model specifically to calculate the impact of the selected strategies at urban level, but the used methods are different. EFFESUS is using “sample building” modelling strategy through a categorization method and tool: it categorises the building stock,

chooses one building as representative of each typology and then extrapolates the results to the whole historic district [15]. ENERPAT will use the same model to extrapolate the results of the monitoring of the living labs. The three demo buildings (living labs) are being monitored by sensors in order to assess the impact of the new solutions at building level. The model will be used to assess the applicability and impact at urban level of these tested solutions.

One of the big differences between the two approaches is the level of required information (and the ambition of the expected results). With the EFFESUS DSS, once the data are included in the model, the assessment of the solutions is an almost automated process. The time required for data collection and generation of the data model is very much dependent on the availability of data and the size of the area to assess. From the beginning of the process until the final results are obtained, an estimated average timeframe would be around two weeks for a medium-sized district. The process described in ENERPAT could take around three years if the whole process is considered: adapting the methodology, selecting the stakeholders and the demo buildings, setting the living labs, co-creation process, installation of the solutions, monitoring (and co-monitoring), analysis of the results and extrapolation.

6. RESULTS and complementarity

The following table summarizes the comparison of the two projects and their methods.

Table 1. Summary of the comparison between EFFESUS and ENERPAT

		EFFESUS	ENERPAT
PROJECT DATA	Duration	4 years (2012–2016)	3 years (2016–2019)
	Funding	Seventh Framework Programme	INTERREG SUDOE
APPROACH		Data driven	Systemic eco-renovation
DECISION MAKING		Through a DSS	Through co-creation strategies
REQUIRED RESOURCES	Time	Low-Medium	High
	Staff	Low	Medium
SOLUTIONS		Universal	Based on local techniques and materials
3D MODEL	Use	Feeding the data for decision making and extrapolation	Only extrapolation
	Modelling strategy	Sample building	Living labs
INDICATORS	Considered indicators	Energy performance (quantitative) Indoor environmental conditions, embodied energy, operational energy, economic return, impact in heritage significance and fabric compatibility (qualitatively)	The EFFESUS indicators + energy poverty, logistical easiness, socio-economic development and citizen acceptance
	Assessment	Calculations	Monitoring + calculations
	Monitoring by sensors	No	Yes
	LCA	Through the characterization of the solutions	Specific study of the whole system
STAKEHOLDERS' INVOLVEMENT		Limited	The whole value chain is involved through living labs
EXPECTED IMPACT		Improvement of energy efficiency and comfort	Systemic change and territorial activation

The comparison of the two approaches clearly shows the difference between them in terms of ambition, required resources and used methods and tools. ENERPAT addressed a valuable systemic perspective but EFFESUS developed some useful tools that can be integrated through the co-creation strategies and help decision makers. As Colander and Kupers stated “*complexity policy is contextual and consists of a set of tools, not a set of rules, that helps the policy maker to come to reasonable conclusions.*” [13]. The EFFESUS model and approach have been proved to be useful for early-stage urban energy decision making [1]. At this stage a long list of solutions can be easily evaluated through the DSS in order to provide to the co-creation process with data for an informed decision in coherence with the recently approved European Standard, EN 16883 (Guidelines for Improving the Energy Performance of Historic Buildings).

7. CONCLUSION

This paper has described the approach of two different projects with a similar goal: the improvement of energy efficiency and sustainability in historic urban environments. Although the projects were close temporally (when EFFESUS finished ENERPAT just started), the evolution from one to another can be seen as a change in the way we see historic cities and their energy improvement: from a linear, mechanistic view, to one based on nonlinear dynamics, evolutionary development, and systems thinking. However, the results of the projects are complementary. The EFFESUS DSS can be highly beneficial for the early stages of an urban energy retrofitting process and provide evidence to the co-creation strategies within the ENERPAT approach. To adopt the ENERPAT strategy, a high political commitment and long-term vision is required. Should it be adopted as an evolutionary strategy, it could be deployed step by step in an incremental and controlled way. Benefits that can be obtained could significantly transform the system of the historic city improving its sustainability and liveability, reinforcing its local economy, preserving its cultural values and including all the stakeholders in the whole process.

8. ACKNOWLEDGMENTS

The EFFESUS project has received funding from the European Union’s Seventh Programme for research, technological development and demonstration under grant agreement No. 314678. The ENERPAT project is cofounded by the Interreg SUDOE program. The authors would like to thank Igone Revilla for her valuable comments and suggestions to improve the quality of the paper.

9. REFERENCES

- [1] A. Egusquiza, I. Prieto, J.L. Izkara, R. Béjar, Multi-scale urban data models for early-stage suitability assessment of energy conservation measures in historic urban areas, *Energy Build.* 164 (2018) 87–98. doi:10.1016/j.enbuild.2017.12.061.
- [2] M.S. Todorović, O. Ećim-Đurić, S. Nikolić, S. Ristić, S. Polić-Radovanović, Historic building’s holistic and sustainable deep energy refurbishment via BPS, energy efficiency and renewable energy – A case study, *Energy Build.* (2014). doi:10.1016/j.enbuild.2014.11.011.

- [3] A. Egusquiza, I. Prieto, A. Romero, Multiscale information management for sustainable districts rehabilitation: EFFESUS and FASUDIR projects, in: *eWork Ebus. Archit. Eng. Constr.–Proc. 10th Eur. Conf. Prod. Process Model. ECPPM 2014*, 2015.
- [4] ICOMOS, *The Washington Charter on the Conservation of Historic Towns and Areas*, (1987).
- [5] J. Jacobs, *The Death and Life of Great American Cities*, Random House, New York, 1961.
- [6] C. Alexander, A city is not a tree, *City*. 122 (1966) 58–62.
- [7] J. Wu, Urban ecology and sustainability: The state-of-the-science and future directions, *Landsc. Urban Plan.* 125 (2014) 209–221. doi:10.1016/j.landurbplan.2014.01.018.
- [8] S. Levin, T. Xepapadeas, A.S. Cripin, J. Norberg, A. De Zeeuw, C. Folke, T. Hughes, K. Arrow, S. Barrett, G. Daily, P. Ehrlich, N. Kautsky, K.G. Muler, S. Polasky, M. Troell, J.R. Vincent, B. Walker, Social-ecological systems as complex adaptive systems: Modeling and policy implications, *Environ. Dev. Econ.* 18 (2013) 111–132. doi:10.1017/S1355770X12000460.
- [9] A. Egusquiza, J.L. Izkara, Facilitating historic districts energy retrofitting through a comprehensive multiscale framework, in: *EECHB 2016 – Energy Effic. Comf. Hist. Build.*, Brussels, 2016.
- [10] S. Salat, *Cities and Forms: On Sustainable Urbanism*, CSTB Urban Morphology Laboratory, Paris, 2011.
- [11] S. Marshall, *Planning, Design and the Complexity of Cities*, in: J. Portugali, H. Meyer, E. Stolk, E. Tan (Eds.), *Complex. Theor. Cities Have Come Age*, Springer, Berlin, 2012.
- [12] R. Crawford, *What can complexity theory tell us about urban planning?*, 2016.
- [13] D. Colander, R. Kupers, *Complexity and the art of public policy: Solving society’s problems from the bottom up*, 2014. doi:10.1111/gove.12292.
- [14] T. Dixon, M. Eames, *Sustainable urban development to 2050: complex transitions in the built environment of cities*, in: T. Dixon, M. Eames, S. Lannon, M. Hunt (Eds.), *Urban Retrofit. Sustain. Mapp. Transit. to 2050*, Routledge, 2014.
- [15] I. Prieto, J.-L. Izkara, A. Egusquiza, Building stock categorization for energy retrofitting of historic districts based on a 3d city model, *Dyna.* 92 (2017). doi:10.6036/8147.
- [16] European Commission, *SC5–21–2016–2017: Cultural heritage as a driver for sustainable growth*, (n.d.).
- [17] C. Roorda, J. Wittmayer, *Transition management in five European cities – an evaluation*, 2014.
- [18] A. Rantanen, A. Joutsiniemi, Strategic planning and epistemology of change: Probing the fitness of urban and planning systems with resilient spatial strategies, in: *Proc. Conf. “Sustainable Futur. a Chang. Clim.*, Helsinki, 2014: pp. 336–347.
- [19] P. Eriksson, C. Hermann, S. Hrabovszky-Horváth, D. Rodwell, EFFESUS Methodology for Assessing the Impacts of Energy-Related Retrofit Measures on Heritage Significance, *Hist. Environ. Policy Pract.* 5 (2014) 132–149. doi:10.1179/1756750514Z.00000000054.